

WILKERSON®

Richland, MI 49083

Tel: (269) 629-5000

Installation & Service Instructions
83-966-000

Electronic DPI for
F18, F28, M18 & M28

ISSUED: February, 2007

Supersedes: October, 1996

Doc. #83966000, EN# 061219, Rev. 2

WARNING

To avoid unpredictable system behavior that can cause personal injury and property damage:

- Disconnect electrical supply (when necessary) before installation, servicing, or conversion.
- Disconnect air supply and depressurize all air lines connected to this product before installation, servicing, or conversion.
- Operate within the manufacturer's specified pressure, temperature, and other conditions listed in these instructions.
- Medium must be moisture-free if ambient temperature is below freezing.
- Service according to procedures listed in these instructions.
- Installation, service, and conversion of these products must be performed by knowledgeable personnel who understand how pneumatic products are to be applied.
- After installation, servicing, or conversion, air and electrical supplies (when necessary) should be connected and the product tested for proper function and leakage. If audible leakage is present, or the product does not operate properly, do not put into use.
- Warnings and specifications on the product should not be covered by paint, etc. If masking is not possible, contact your local representative for replacement labels.

Safety Guide

For more complete information on recommended application guidelines, see the Safety Guide section of Pneumatic Division catalogs or you can download the Pneumatic Division Safety Guide at: www.wilkersoncorp.com

Application Limits

These products are intended for use in general purpose compressed air systems only.

Electrical Rating:

5 Amps - 12/24VDC, 125/250VAC

With Polycarbonate Bowl

	kPa	PSIG	bar
Operating Pressure Maximum	1000	150	10.3
Operating Temperature Maximum	52°C (125°F)		
Operating Temperature Minimum	0°C (32°F)		

With Metal Bowl

	kPa	PSIG	bar
Operating Pressure Maximum	1700	250	17.0
Operating Temperature Maximum	66°C (150°F)		
Operating Temperature Minimum	0°C (32°F)		

Operation and Service

1. The particulate and coalescing filter element should be removed and replaced when pressure differential across the filter is 10 PSID.
2. Adsorber elements are designed to adsorb vaporous contaminants. The relative efficiency of an adsorber varies depending on the vapor to be adsorbed and the environmental temperature. At higher temperatures, adsorbers become less efficient.

Adsorber elements are not particle filters. All particles and aerosols should be removed prior to adsorbing vaporous contaminants. The initial pressure drop across an adsorber element (1.5 PSIG maximum) should never increase. The presence of any liquids, aerosols or particulate matter in an adsorber indicates that the effective life of the element has been exceeded and the element should be replaced and the system cleaned.

The most effective method of testing whether an element needs to be replaced is to smell the air coming from the adsorber. Offensive odors will be present well before oil levels become detectable.

3. If the electronic differential pressure indicator, located on top of the filter body is wired as normally open, it sends an electrical signal when the differential is greater than the specified range. If the electronic differential pressure indicator is wired as normally closed, there will be a signal until the differential exceeds the specified range. Change the filter element when this happens. For units without a differential pressure indicator, pressure differential gauges should be used to determine when the maximum recommended pressure differential has been reached.
4. Shut off air supply and depressurize the unit, before servicing.
5. After servicing, apply system pressure and check for air leaks. If leakage occurs, **Do Not Operate** — conduct servicing again.

WARNING

FAILURE OR IMPROPER SELECTION OR IMPROPER USE OF THE PRODUCTS AND/OR SYSTEMS DESCRIBED HEREIN OR RELATED ITEMS CAN CAUSE DEATH, PERSONAL INJURY AND PROPERTY DAMAGE.

This document and other information from The Company, its subsidiaries and authorized distributors provide product and/or system options for further investigation by users having technical expertise. It is important that you analyze all aspects of your application, including consequences of any failure and review the information concerning the product or systems in the current product catalog. Due to the variety of operating conditions and applications for these products or systems, the user, through its own analysis and testing, is solely responsible for making the final selection of the products and systems and assuring that all performance, safety and warning requirements of the application are met.

The products described herein, including without limitation, product features, specifications, designs, availability and pricing, are subject to change by The Company and its subsidiaries at any time without notice.

EXTRA COPIES OF THESE INSTRUCTIONS ARE AVAILABLE FOR INCLUSION IN EQUIPMENT / MAINTENANCE MANUALS THAT UTILIZE THESE PRODUCTS. CONTACT YOUR LOCAL REPRESENTATIVE.

Electronic DPI

83-966-000

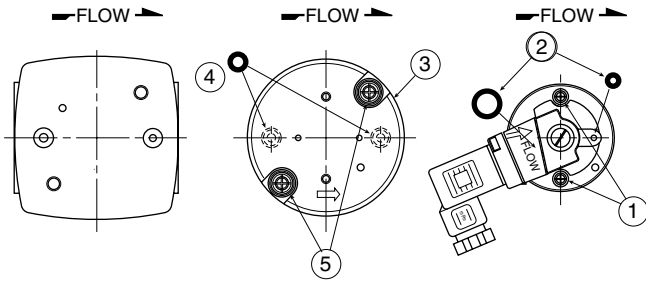

Orientation / Assembly for M18 Electronic DPI

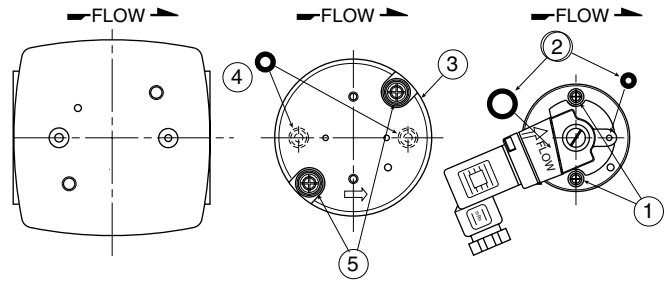

Orientation / Assembly for M28 Electronic DPI

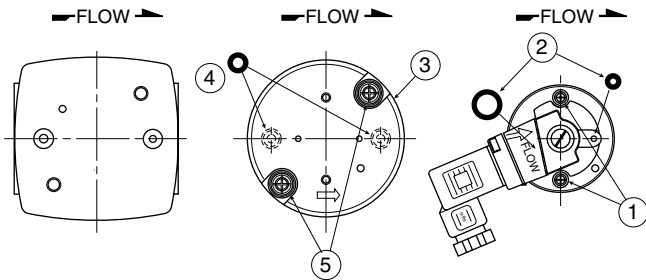

Orientation / Assembly for F18 Electronic DPI

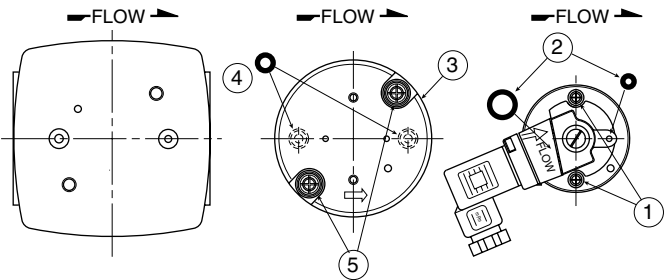

Orientation / Assembly for F28 Electronic DPI

- Item 1: Screws (2) for mounting Electronic DPI
- Item 2: Electronic DPI with two Seals - Preset at 10 PSID
- Item 3: DPI Adapter Plate

- Item 4: -007 O-rings (2)
- Item 5: Screw (2) for mounting Adapter

Wiring Code

- Pin 1: Common
- Pin 2: Normally Closed
- Pin 3: Normally Open

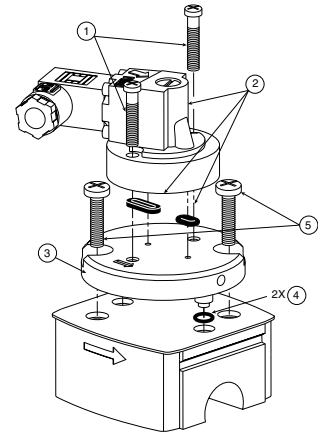
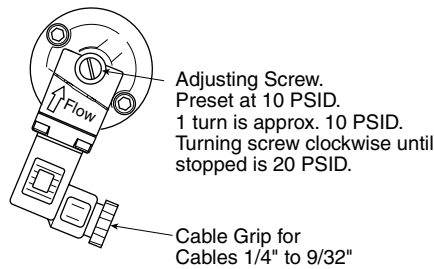
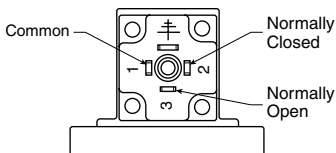

Kits Available

Description	M18	M28	F18	F28
Electronic DPI Conversion Kit	GRP-96-823	GRP-96-823	GRP-96-823	GRP-96-823
Electronic DPI Replacement Kit	GRP-96-824	GRP-96-824	GRP-96-824	GRP-96-824
Element Kits:				
0.5 Micron (Coalescing)	MSP-96-647	MSP-96-649	—	—
0.1 Micron (Coalescing)	MTP-96-646	MTP-96-648	—	—
Adsorber (Coalescing)	MXP-96-650	MXP-96-651	—	—
5 Micron	—	—	FRP-96-639	FRP-96-653
Bowl O-Ring (Nitrile)	GRP-96-640	GRP-96-654	GRP-96-640	GRP-96-654
Bowl O-Ring (Fluorocarbon)	GRP-96-754	GRP-96-755	GRP-96-754	GRP-96-755
Filter Retainer Element Baffle	—	—	FRP-96-641	FRP-96-283
Manual Drain	GRP-96-685	GRP-96-685	GRP-96-685	GRP-96-685
Manual Override Drain	GRP-96-001	GRP-96-001	GRP-96-001	GRP-96-001
Bowl Kits:				
Plastic Bowl / Guard Manual Drain	GRP-96-634	GRP-96-642	GRP-96-634	GRP-96-642
Metal Bowl / Sight Gage Manual Drain	GRP-96-636	GRP-96-644	GRP-96-636	GRP-96-644
Plastic Bowl / Bowl Guard Automatic Drain	GRP-96-635	GRP-96-643	GRP-96-635	GRP-96-643
Metal Bowl / Sight Gage Automatic Drain	GRP-96-637	GRP-96-645	GRP-96-637	GRP-96-645
Plastic Bowl / Bowl Guard No Drain	GRP-96-638	GRP-96-652	GRP-96-638	GRP-96-652