



Drilling Products Overview

Total rig package solutions for your drilling needs



Content

Total rig packages solutions	4
------------------------------------	---

Drilling pressure control equipment

Blowout preventers (BOPs)	6
Rams and ram packers	8
Connectors	10
ESG system	11
Capping stack	12
Riser systems	14
Diverters	17
BOP controls and monitoring systems	18
Manifold systems	22
Valves	27

Drilling equipment

HMI and controls systems	30
OnTrack system	32
Drawworks	36
Equipment	39
Top drive systems	41
Vertical pipe handling systems	43
Horizontal pipe handling systems	45
Pipe deck crane	47
Drillfloor pipe handling equipment	48
Hydraulic roughnecks	49
Drillfloor tools	52
Cellar deck equipment	53
Stab-in connection system	55
Hydraulic power units	56
Motion compensation equipment	57
Drilling derricks	61
Well intervention packages	62

Total drilling fluid solutions

Mud control system	66
Mud mixing system	68
Bulk storage and transfer system	70
Mud treatment system	72
Low-pressure system	73
High-pressure system	74
Mud modules	75
Containerized solutions	75
Surveys and upgrades	76

Services

Services	78
Global network	82



Total Rig Package Solutions

Cameron Total Rig Package Solutions bring the Cameron reputation for safety and reliability to all your equipment and service needs. This complete suite combines our best-in-class equipment and comprehensive services, providing customers with a lower total cost of ownership. Through our worldwide network of resources, we present full life cycle support, from conceptual design to a full range of services. And our global infrastructure provides service and support wherever and whenever needed. For reliable rig equipment and far-reaching service, the clear choice is Cameron.

Cameron understands that maximizing uptime means lower total cost of ownership and greater returns for our customers. With growing demands for rig efficiency, the value of safety and reliability cannot be overstated. Through a comprehensive approach that impacts every aspect of our business, Cameron is dedicated to ever-increasing rig efficiency.

Quality and performance

Cameron invests in state-of-the-art engineering and unrelenting quality control processes throughout the design, engineering, project management, and manufacturing of your equipment. This has garnered a reputation in the industry for high-performance, quality products.

Service and support

Providing technical expertise and extensive training programs, Cameron services are available to help you meet your objectives throughout the life cycle of your project. With your return on investment in mind, our network of technical specialists spans the globe so there's no waiting for support.

Integrated solutions

Cameron Total Rig Package Solutions ensure your entire system incorporates a high level of product integrity. By leveraging a cohesive package that's built to withstand the specific challenges of your project, you assure more reliable long-term performance and lower costs.

DRILLING PRESSURE CONTROL EQUIPMENT

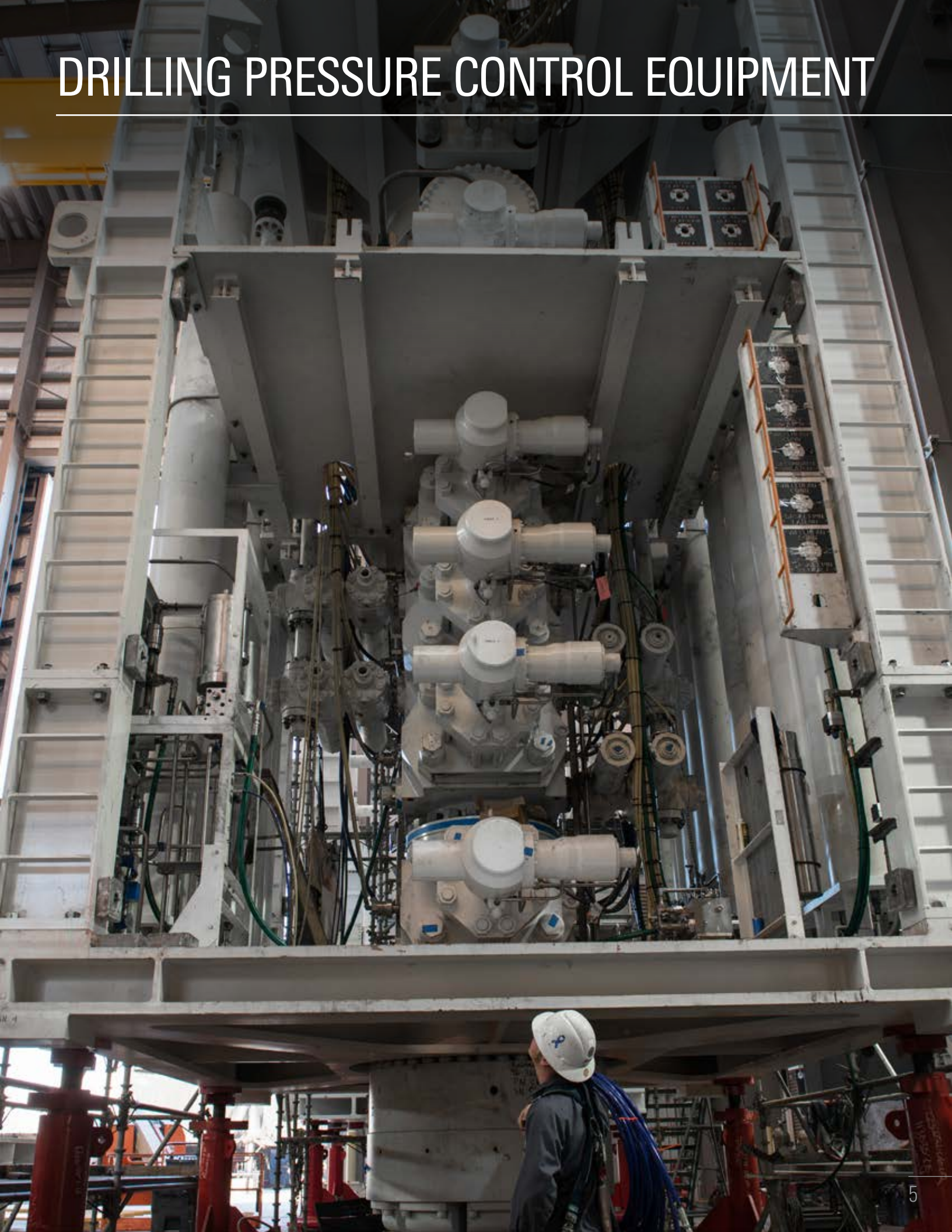

Blowout Preventers (BOPs)

Focused on reliability and safety, Cameron continues to innovate in response to your drilling BOP needs. With the world's largest installed base of BOPs, Cameron has provided a legacy of technology leadership, from the industry's first BOP in 1922 to the world's first 13-5/8 in 25,000 psi BOP. With Cameron, reliability begins in the design phase and continues through the use of proprietary products, including high-performance elastomers.

Ram-Type BOPs

Cameron offers an extensive product line of ram-type BOPs with features that help to reduce rig maintenance and downtime.



EVO* Compact Offshore BOP

Application	Offshore (subsea and surface) and onshore
Bore sizes and working pressures	18-3/4 in 15,000, 20,000 psi
Body styles	Single, double, triple
Pressure-energized rams	Yes
Lock type(s)	Hydraulic; EVO-Loc* BOP locking system and motors
Bonnet studs instead of bolts:	Yes

Tandem booster bonnets available for increased shearing and sealing capabilities. Super shear bonnets available for shearing casing.

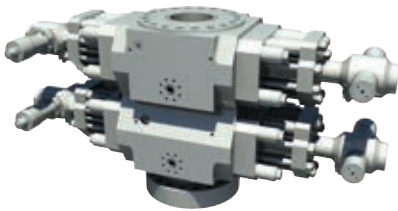

TL* Offshore Ram-Type BOP

Application	Offshore (subsea and surface) and onshore
Bore sizes and working pressures	18-3/4 in 5,000, 10,000, 15,000, 20,000 psi
Body styles	Single, double, triple
Pressure-energized rams	Yes
Lock type(s)	Hydraulic; RamLocks (5,000, 10,000, 15,000 psi working pressure), ST lock (10,000, 15,000, 20,000, 25,000 psi working pressure), Wedgelocks (5,000 psi working pressure)
Bonnet studs instead of bolts	Yes

Tandem booster bonnets available for increased shearing and sealing capabilities. Super shear bonnets available for shearing casing.



U* Onshore Ram-Type BOP

Application	Offshore (surface) and onshore
Bore sizes and working pressures	7-1/16 in, 11 in, 13-5/8 in 3,000 to 15,000 psi; 16-3/4 in 3,000 to 10,000 psi; 20-3/4 in 3,000 psi; 21-1/4 in 2,000, 5,000, 10,000 psi; 26-3/4 in 3,000 psi
Body styles	Single, double, triple, quad
Pressure-energized rams	Yes
Lock type(s)	Manual locks standard; hydraulic locks optional
Hydraulically opening bonnets	Yes

Large bore bonnets and FXT bonnets available for increased shearing and sealing capabilities.

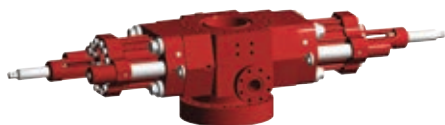

UM* Convertible-Bonnet Ram-Type BOP

Application	Offshore (subsea and surface) and onshore
Bore sizes and working pressures	7-1/16 in and 11 in 3,000 to 15,000 psi; 13-5/8 in 10,000 psi
Body styles	Single, double, triple, quad
Pressure-energized rams	Yes
Lock type(s)	Manual locks standard; hydraulic locks optional
Hydraulically opening bonnets	Yes
Bonnet studs instead of bolts	Yes

Large bore bonnets and FXT bonnets available for increased shearing and sealing capabilities.

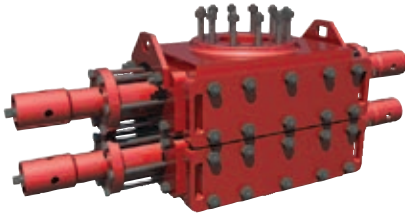

T-81 Small-Bore Compact Ram-Type BOP

Application	Onshore
Bore sizes and working pressures	7-1/16 in 3,000, 5,000 psi; 9 in 3,000, 5,000 psi
Body styles	Single, double, triple
Pressure-energized rams	Yes
Lock type(s)	Manual locks only
Hydraulically opening bonnets	Yes
Bonnet studs instead of bolts	Yes; also studs on the door



T-82 Compact Ram-Type BOP

Application	Onshore
Bore sizes and working pressures	7-1/16 in 3,000, 5,000 psi; 11 in 3,000, 5,000 psi; 13-5/8 in 3,000, 5,000 psi
Body styles	Single, double
Pressure-energized rams	Yes
Lock type(s)	Manual locks only
Hydraulically opening bonnets	Yes
Bonnet studs instead of bolts	No

Annular BOPs

Cameron offers a variety of field-proven annular BOPs to fit your desired drilling applications. Our portfolio includes models that feature a quick-release top for prompt packer changeout and, when vertical space is limited, reliable solutions in a compact design.



DL High-Pressure Annular BOP

Application	Offshore (subsea and surface) and onshore
Bore sizes and working pressures	7-1/16 in to 21-1/4 in and 2,000 to 10,000 psi
Body styles	Single, dual configurations available for certain sizes
Packer	High-performance CAMULAR* annular elastomer technology



T-84 Low-Pressure Annular BOP

Application	Onshore
Bore sizes and working pressures	7-1/16 in 3,000, 5,000 psi; 9 in 3,000 psi; 11 in 3,000, 5,000 psi; 13-5/8 in 3,000 psi
Body styles	Single
Packer	Synthetic rubber



T-90 Short-Body Annular BOP

Application	Onshore
Bore sizes and working pressures	7-1/16 in 3,000, 5,000, 10,000 psi; 9 in 3,000 psi; 11 in 3,000, 5,000 psi; 13-5/8 in 3,000, 5,000 psi
Body styles	Single
Packer	Synthetic rubber

Rams and Ram Packers

Cameron offers the most comprehensive line of rams and ram packers in the industry. Our rams cover a wide range of drilling requirements, including shearing high-strength casing and drill collars. Cameron also offers a choice of rams for variable bore sealing and high-temperature applications.

Cameron is known as a pioneer in variable bore sealing technology. The name variable bore ram (VBR) is synonymous with the CAMERON* VBR*. In addition, Cameron offers FLEXPACKER* ram technology, FLEXPACKER NR* narrow-range ram packer, and dual bore FLEXPACKER technology, which provide sealing on specific bore sizes.

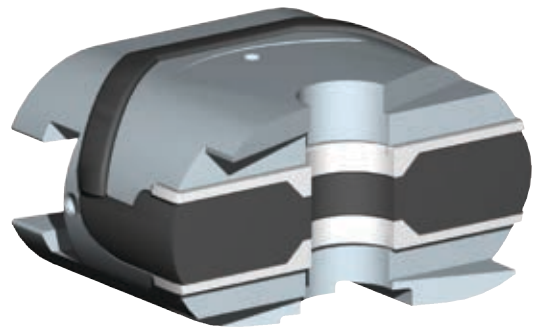

Pipe ram

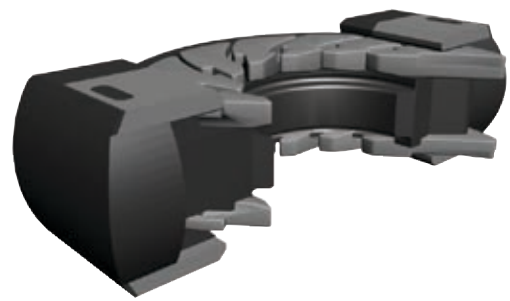

VBR



CDVS cable double-v shear ram

Elastomer Technology

One of the many ways to differentiate Cameron drilling products from those of other manufacturers is the elastomers used in critical sealing areas, such as ram packers and top seals.

Cameron drilling products exclusively feature proprietary elastomers designed and manufactured by our facility in Katy, Texas. Cameron provides engineered solutions to elastomeric material problems, and for drilling applications, we have developed CAMRAM*, CAMRAM 350*, CAMULAR, CAMLAST* and DUROCAM* elastomer technology to meet the rigorous demands of the oil field. This technology, when used in Cameron ram-type BOPs and annular BOPs, help to improve performance, extend service life, reduce downtime, and lower operating costs. Elastomer components are in-house engineered technology with required API testing as with all other pressure control equipment.

RAM SELECTION CHART

Ram description		Ram-type BOP models					
		EVO	TL	U	UM	T-81	T-82
Shearing	SBR shearing blind ram	●	● ^{††}	●	●	—	—
	DVS double 'v' shear ram	●	● ^{††}	● ^{††}	● ^{††}	—	—
	SSR super shear ram [†]	●	●	●	● ^{††}	—	—
	H ₂ S SBR shearing blind ram	●	●	●	●	—	—
	DS dual string shear ram	—	—	● ^{††}	● ^{††}	—	—
	ISR interlocking shear ram	—	—	● ^{††}	● ^{††}	—	—
	DSI dual string interlocking shear ram	—	—	● ^{††}	●	—	—
	CDVS cable double v shear ram	●	●	—	—	—	—
Variable bore	VBR-II* variable bore ram	● ^{††}	● ^{††}	● ^{††}	● ^{††}	—	—
	FLEXPACKER	● ^{††}	● ^{††}	● ^{††}	● ^{††}	—	—
	FLEXPACKER-NR	● ^{††}	● ^{††}	● ^{††}	● ^{††}	● ^{††}	—
	Dual bore FLEXPACKER	● ^{††}	● ^{††}	● ^{††}	● ^{††}	—	—
Pipe	Standard service	●	●	●	●	●	●
	High temp service	●	●	●	●	●	—

[†] Non-sealing ram; does not contain elastomeric material.

^{††} Contact your local Cameron representative to learn more about specific sizes.

Connectors

As drilling depths have increased, Cameron has expanded its product offerings to include a full range of collet connectors able to secure your subsea BOP stack connections from shallow to ultra-deepwater environments.

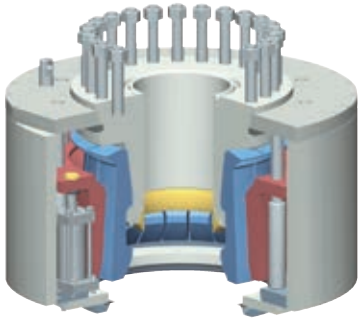

Model 70 connector

The Model 70 collet connector is offered in sizes and pressure ratings for a wide variety of applications.

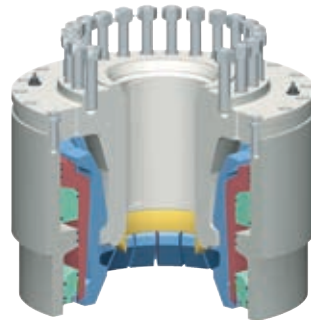

HC connector

The HC high-capacity collet connector is similar to the Model 70 connector, but is designed to provide greater preload to withstand higher separating forces.

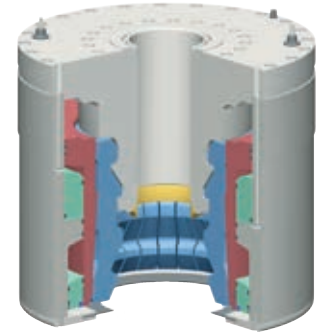

DWHC connector

The DWHC deepwater, high-capacity collet connector is a high-strength drilling and completion collet connector, engineered for the high loads encountered in ultra-deepwater applications.

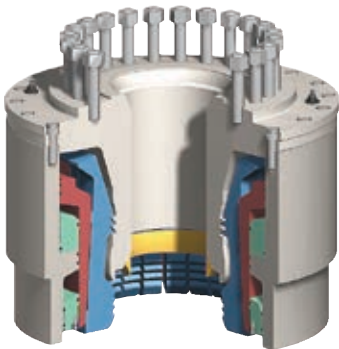

HCH4 connector

The HCH4 connector locks onto an H4 wellhead.

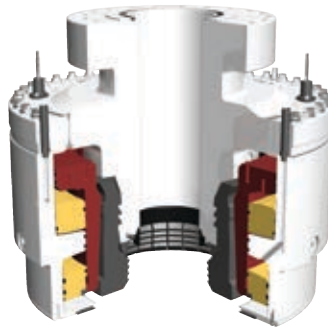

EVO-Con connector

The EVO-Con adaptable collet connector works on various wellheads, giving you increased versatility and capacity, and is made with only one hydraulic unit.*

ESG System

The Cameron ESG* environmental safeguard BOP control system is a safe, reliable and cost-effective alternative to traditional subsea drilling practices, combining field-proven equipment into an evolutionary new system.

Evolving traditional methods one step further, the Cameron ESG system utilizes a floating vessel equipped with a combination of subsea and surface modules. The subsea portion, at only a fraction of the size and weight of a traditional subsea stack, is used to shear, seal and disconnect from the seabed while the traditional surface BOP stack handles all the well control functions.

The subsea stack consists of upper and lower wellhead connectors, a ram-type BOP with shearing blind rams and a mini (acoustic, electric, ROV-actuated or hydraulic) control system. The subsea portion is connected to a traditional surface BOP stack via a high-pressure riser system, Cameron exclusive triple-barrel telescoping joint and a motion compensation system.

In the event of an emergency, the control system is used to signal the subsea BOP to shear the pipe. Once the shearing blind rams shear and seal off the bore, the control system is used to signal the upper connector to disconnect, allowing the rig to be moved safely off location with minimal loss of drilling or well fluids.

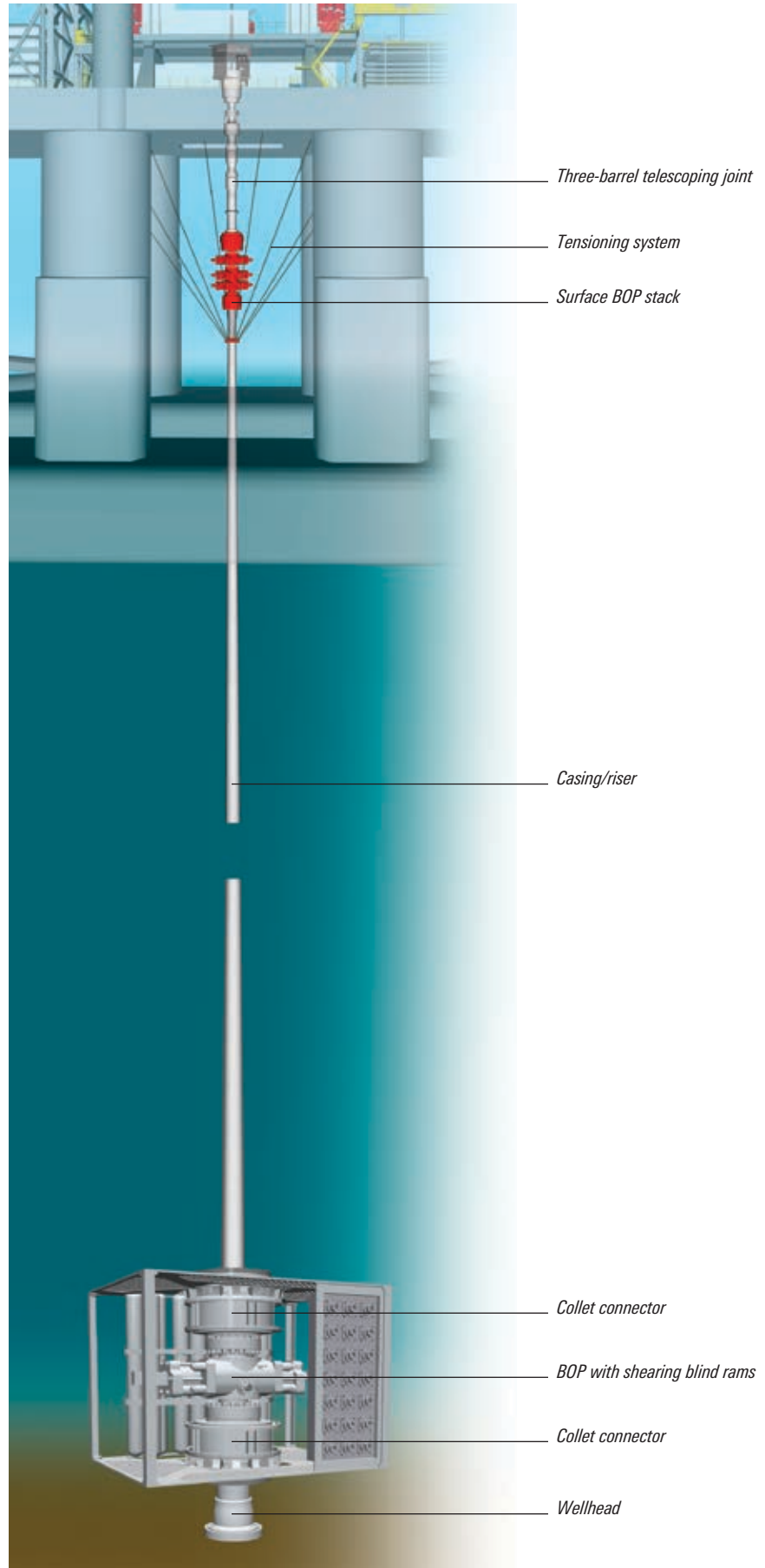

Capping Stack

Building on a legacy of innovative BOP products, Cameron now designs and manufactures capping stacks. These stacks provide an additional method for safely shutting in a well or diverting the flow to a containment system. These small, lightweight stacks, varying in size and working pressure, are designed to fit on top of a subsea BOP stack or wellhead and can be configured per customer's request.

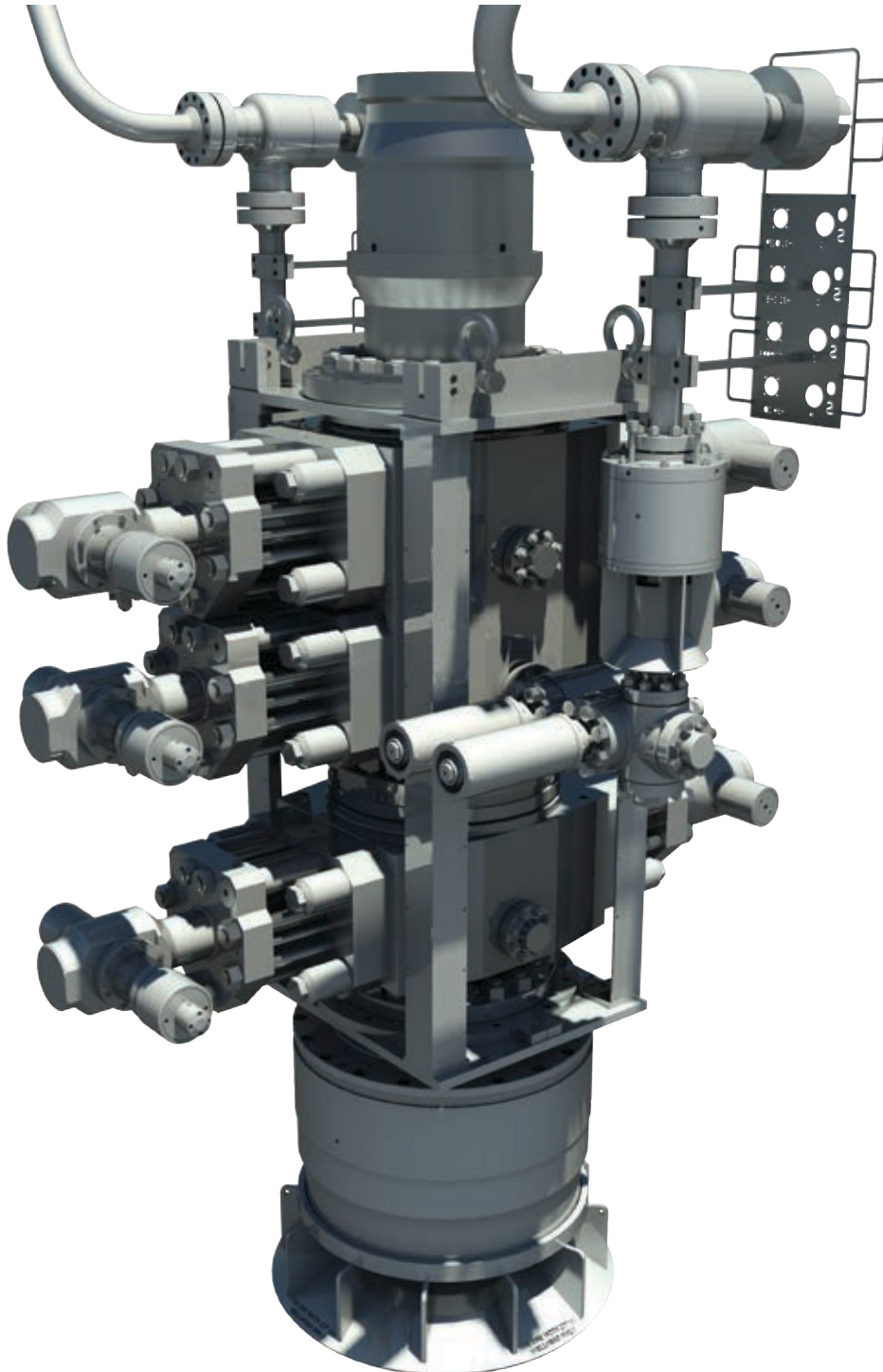



Riser Systems

Cameron offers drilling riser systems that accommodate the stringent conditions encountered in ultra-deepwater drilling, including high-tension loads, multiple control lines and the need to respond to changes in surface weather conditions. Riser sections are available in varying lengths, wall thicknesses and with preps for buoyancy materials as required.



LoadKing riser system

Cameron LoadKing* ultradeepwater riser systems is designed to meet the demands of ultra-deepwater drilling in water depths of 7,000 ft (2,133.60 m) or more. LoadKing riser system are available with tension ratings up to 4 MMlb. LoadKing riser systems incorporate many of the features of the RF riser system while holding the weight of the riser joints to less than 2% heavier than a comparably equipped RF riser system.

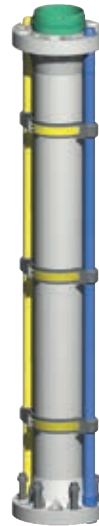

RF riser system

The Cameron RF* riser system is designed to meet the drilling industry's needs for a midwater riser system. Less costly and quicker to operate than conventional systems, RF riser systems are available with tension ratings up to 2 MMlb.



Telescoping joint

The Cameron Telescopic Joint (TJ) compensates for rig heave. It is a riser joint consisting of an inner and outer barrel with a sealing element. Cameron offers a dual seal assembly (DSA) for sealing between the inner and outer barrel. The autolock feature secures the inner and outer barrel to ensure the telescopic joint can safely run and land the BOP. The Cameron TJ can be provided as MPD ready, with an inner barrel sized to accommodate passing a rotating control device and associated deployment tooling.



Riser fill up valve

The Cameron riser fill up valve is a special riser joint with an automatic or hydraulically operated actuator designed to prevent riser collapse should drilling fluid levels drop within the riser.

Riser running tools

Cameron riser running tools feature integrated running and testing functionality. The devices handle risers for lifting and assembling the riser into the riser string and pressure testing the lines. Cameron running tools are qualified up to 2.75 MMlb. Removable test plugs eliminate the need to stab a test sub for every joint. Hydraulic and manual tools are available.



Spider and gimbal

The Cameron spider serves as a hang off point for the riser during BOP running. Cameron offers split spiders and gimbals to accommodate rotary tables of 49.5 in (1,257.3 mm), 60.5 in (1,536.7 mm), and 75.5 in (1,917.7 mm) in diameter and are qualified up to 2.5 MMlb hang off capacity. Cameron spiders are designed so that the only moving parts are the spider dogs. For improved safety, the 75.5 in (1,917.7 mm) spider dogs completely cover the open hole when hanging off a riser joint. The shock mount gimbal allows up to a 5-degree movement in all directions. The Cameron spider design can be configured to readily accommodate the Robo-Spider* automated riser-flange-bolt torque system.



Tension ring

The Cameron tension ring secures the tensioning lines to the telescopic joint. Cameron offers solid body and split tension rings to accommodate both wireline and direct acting tensioning systems. Cameron tension rings are qualified up to the same capacity as the riser system with which they are coupled.



FlexKing subsea flex joint

Cameron FlexKing subsea flex joints permit angular displacement up to ± 10 degree. They are rated up to 6,000 psi and are certified to water depths up to 12,000 ft (3,657.6 m).

BOP landing assist tool

The Cameron BOP Landing Assist Tool (BLAT) locks into the riser string below the telescopic joint inner barrel to allow hang off to be supported by the derrick instead of the tensioning system. The BLAT can support up to 2.5 MMlb and interfaces with either the outer barrel of the telescopic joint or a modified pup joint.

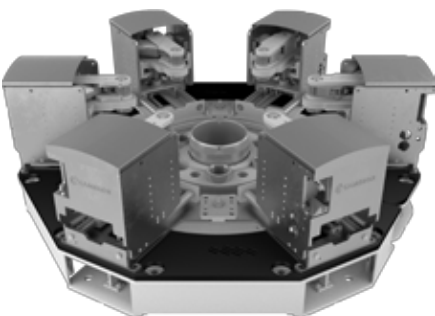

Robo-Spider system

The Cameron Robo-Spider system is an automated riser flange bolt torque system capable of reducing riser flange bolt torque time by up to 70%, while increasing rig floor safety.



Riser gas handling system

The Cameron RGH riser gas handling system utilizes a subsea diverter to permit the safe handling of gas in the riser. The system includes an annular for sealing the riser annulus and a gas bleed spool to safely bleed off gas and mud to a choke manifold. Standard configurations are available to accommodate an HSE system or a Managed Pressure Drilling (MPD)-ready system.



Stab-in connection system

The STiCS stab-in connection system provides hands-free remote operation for installation of goosenecks on the telescopic joint, reducing time and potential hazards that can occur during the connection of the choke, kill, and other auxiliary lines.

For more information on the STiCS system, refer to page 61.

Diverters

Cameron diverter solutions provide low-pressure flow control to direct wellbore fluids away from the immediate drilling area to maximize safety of personnel and equipment. These diverters are used primarily to divert drilling fluids to mud systems in shallow fluid and gas flows, drilling with a rotating head, or drilling with a marine riser. Cameron offers the CF-A low-pressure flow control floater diverter for floaters and the CF-B low-pressure flow control jackup diverter for jack-up rigs.



CF-B diverter



Diverter housing

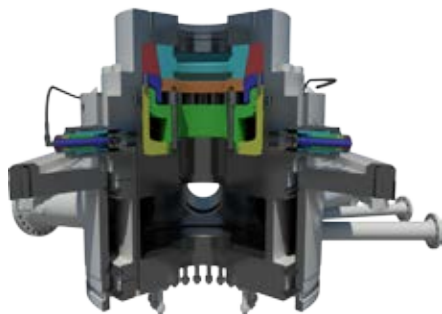

CF-A diverter

The Cameron CF-A diverter is fully customizable for customer-specific floater operations and is designed for reliable, efficient use. The system consists of a diverter housing, outlet valves, running tools, controls system, diverter assembly, and storage skid.

The CF-A diverter supports up to 75.5 in rotary tables and has a hang off capacity of up to 2.5 MMlb. It is a single annular packing element with a pressure rating up to 500 psi. The CF-A model features four hydraulic locking dogs that also provide hydraulic functionality, thus reducing hosing and providing a simplified running and retrieval of the diverter assembly. It also eliminates the need to secure hoses to the diverter assembly while providing hydraulic fluid for the operations.



CF-B diverter

The Cameron CF-B diverter is fully customizable for customer-specific jack-up rig operations and is designed for reliable, efficient use. The system consists of a diverter housing, outlet valves, running tools, controls system, diverter assembly, overshot packers, and storage skids.

The CF-B diverter supports up to 49 in rotary tables and is qualified up to 1,000 psi. Packers can be split and hinged to allow them to be changed out with pipe in the hole. J-slot type running tools are entirely mechanical and require no hydraulics. The bolt-on hydraulic stabs automatically engage receptacles in the diverter housing during deployment, thus eliminating the need to make/break hydraulic connections during running and retrieval.



CF-A diverter and running tool

BOP Controls and Monitoring Systems

As a leading supplier of BOPs, Cameron is uniquely qualified to design, manufacture, install and service drilling control systems tailored to the specific requirements of Cameron BOPs. By providing superior design, dependable performance and excellent field service, Cameron is an industry leader in the supply of drilling control systems for land, platform and subsea applications. Available controls range from simple-hydraulic to all-electric systems.

BOP control systems from Cameron feature a modular design using pre-engineered, field-proven components. The unique modular design allows simple installation and retrieval of the control pod utilized in our multiplex (MUX) systems, which leads to reduced maintenance time and costs. Cameron control systems feature the latest technology with new advances in safety and functionality, providing for operational efficiency.

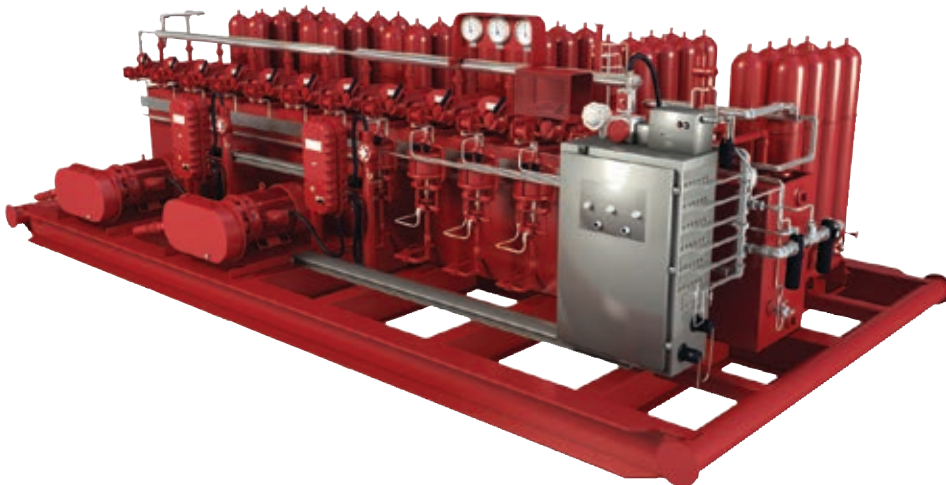
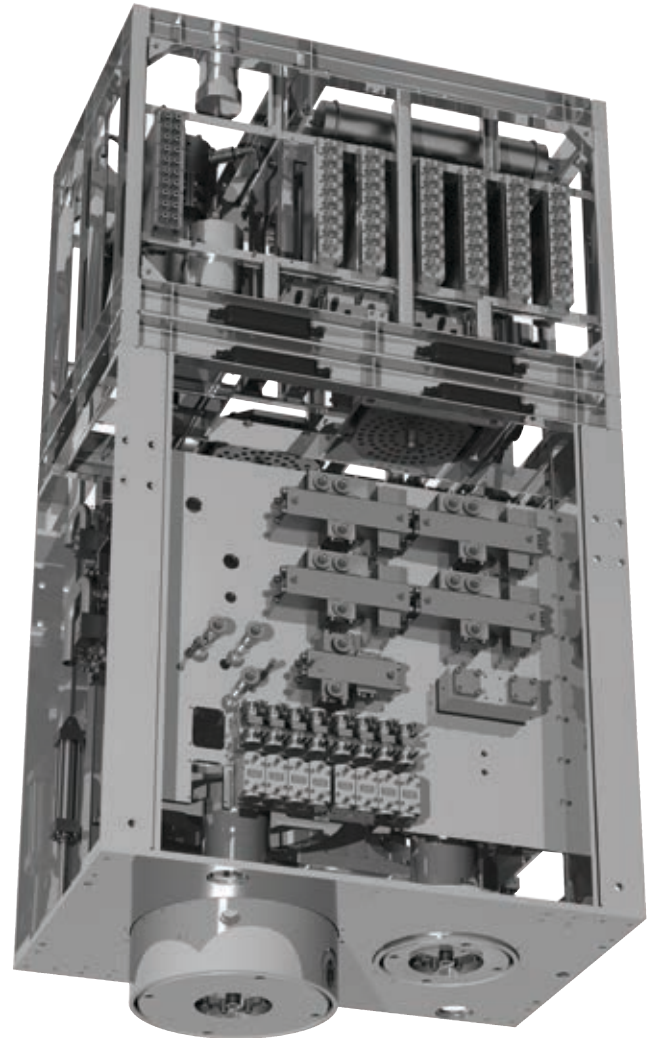

Land and platform hydraulic

Cameron hydraulic control systems for land and platform BOPs supply hydraulic fluid used to operate the stack and associated equipment. These systems feature field-proven and reliable components designed for dependability and field serviceability. The valves use sliding CAMERON metal-to-metal shear seals for maximum tolerance of fluid contamination.



EH MUX subsea electro-hydraulic multiplex systems

Cameron compact, lightweight EH MUX systems combine modular, field-proven components with dual-redundant electronics to provide the rapid actuation required of BOPs operating in deep water.

For operating equipment in shallower water depths, Cameron offers direct-hydraulic and piloted-hydraulic drilling control systems to deliver superior BOP control at an economical cost. Like the EH MUX systems, the piloted systems offer robust, field-proven components, but are controlled via electric connections between the surface controls and subsea control pod.



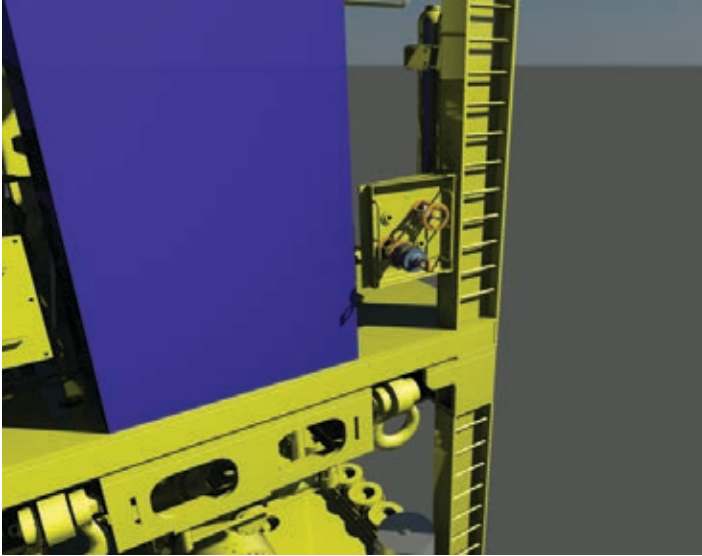

LMRP ROV wireless data and power connection point and ROV retrievable black box recorder

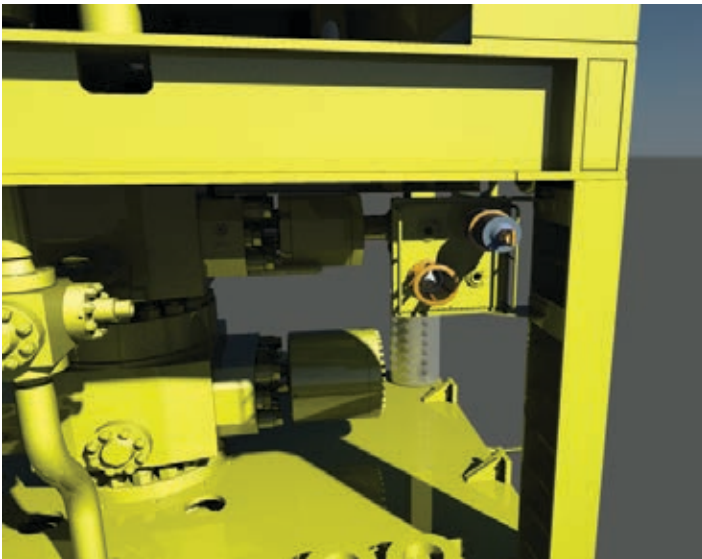

Lower Stack ROV wireless data and power connection point and ROV retrievable black box recorder

Cognition subsea BOP monitoring system

The Cameron Cognition* monitoring system is a network of sensors, data recorders, and communications fitted to the subsea stack of new or existing BOP assemblies, that administers mission critical information for real-time monitoring, condition based maintenance, and emergency mitigation.

Monitoring the parameters of condition in BOP equipment provides access to crucial details about performance and reliability. This presents drillers with new insight to proactively manage maintenance which is essential to maximizing operational uptime. Also, this progressive set of statistics contributes vital intelligence to identify and respond in well control emergencies. Redundant “black box” recorders store several weeks of data enabling ROV recoverable forensics of time-stamped information.

The Cognition monitoring system has the flexibility to incorporate a wide range of installer selected sensors, including but not limited to BOP ram position, hydraulic fluid condition, stack accumulator bottle volume, and solenoid performance. Four redundantly accessible data transmission paths are designed to increase availability, which includes the main umbilicals, ROV stab access points, ROV inductive high-capacity connectivity, and an acoustic system that also facilitates local power. Each connection is capable of energizing sensors and reading data from subsea historians independently of the native BOP control system. All measurements are accessible from any single connection point, implementing an unprecedented level of redundancy.

Additionally, the Cognition Knowledge Base* software provides advanced analytics, alerts, alarms, and reports that synthesize both real-time and historical data into advantageous information. The complete package solution offers the most value to aid in preventing failures, reducing downtime, and extending the operational life of subsea BOP equipment.



Manifold Systems

Cameron offers manifold systems including choke and kill manifolds, drilling chokes, mud standpipe manifolds, cement manifolds, mud gas separators, glycol injection units, and manifold control systems for improved pressure and flow control in onshore and offshore applications.

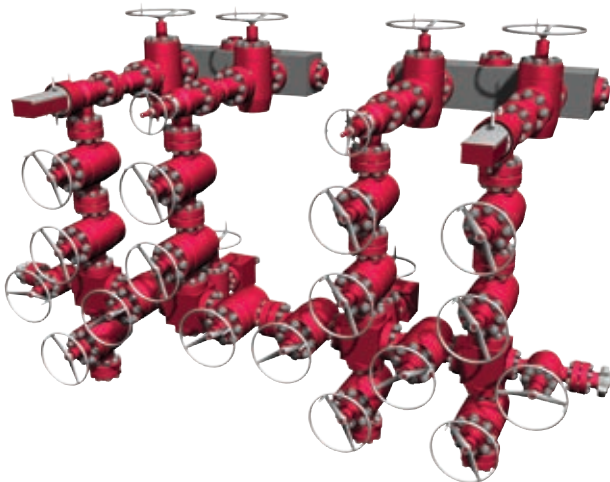
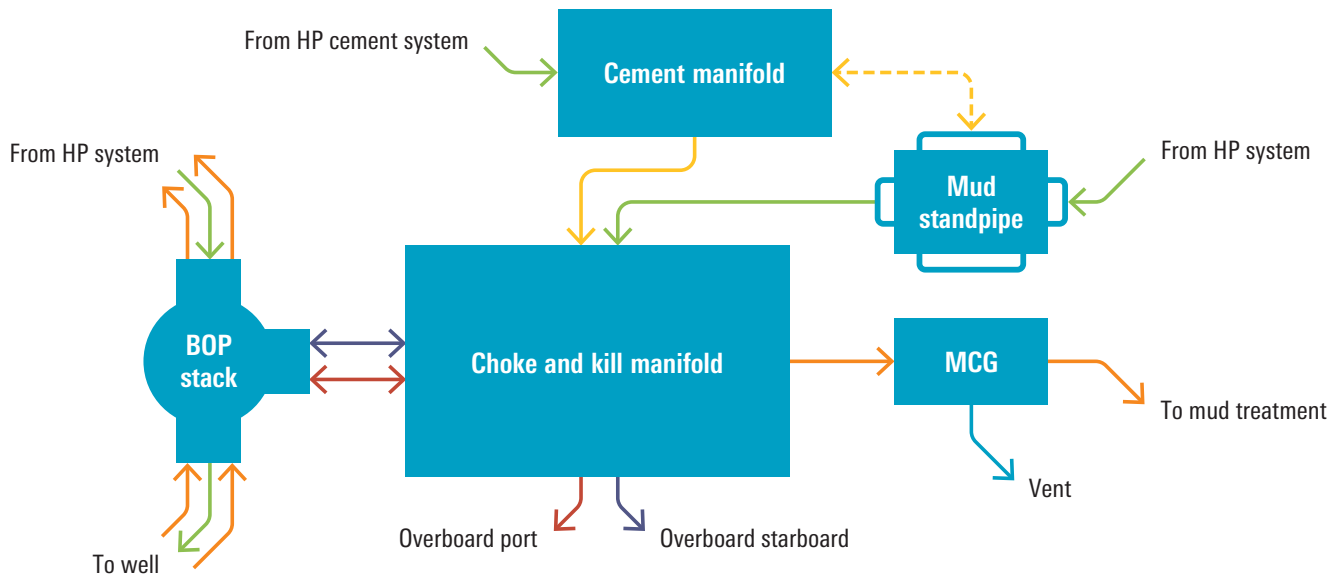

Offshore manifold



Onshore manifold



Drilling choke

Drilling chokes

The Cameron drilling choke product range consists of two main choke types: the CAMERON* DR gate and seat type and the WILLIS* Multiple Orifice Valve (MOV) rotating disc type. These chokes control the pressure in the well bore during drilling, circulate out any kicks of gas encountered during drilling, and prevent loss of well control by maintaining a satisfactory column of drilling mud. With several options and configurations, Cameron drilling chokes offer proven performance within diverse drilling applications on a global scale.

- Controlling components (gate and seat) of DR Type gate-and-seat drilling choke valves as well as the disc components of WILLIS MOV-type drilling chokes are made from solid tungsten carbide for maximum durability and increased service life
- Available in manual and hydraulically actuated configurations
- Actuated configuration with a pneumatic pressure-type position indicator is standard (digital position sensor is optional)



Choke and kill manifolds

The Cameron choke and kill manifold provides control of flowback or treatment fluids. With a commitment to offer the highest quality, safest, and most reliable products on the market, Cameron choke and kill manifolds undergo design, development, and production processes that adhere to our rigorous OEM protocol. Every element of the choke and kill manifold, from gate valves to chokes, must meet meticulous design standards, qualification testing, and material selection. The manufacturing of each manifold system is done in-house by our trained employees. This attention to detail is what you can expect from the best-in-class pressure-control equipment provider.

- Compliance with API standard 53 and API spec 16C
- ABS and DNV certification
- API 6A monogrammed components
- Material class DD-0.5 to EE-NL
- Temperature class L to X (-50 to 350 degF [-45 to 176 degC])
- Product specification level: PSL 2 or 3
- Inconel* 625 inlay available
- Hydraulically actuated components to allow for remote operation

Options include: standard or custom configurations, instrumentation for pressure readings, ports for glycol injections, various structural components to operate chokes and valves, etc.

Mud standpipe manifolds

Cameron mud standpipe manifolds are designed and manufactured to customer requirements and are fully certified in accordance with the recognized oilfield equipment standards.

The mud standpipe manifold is installed downstream of the mud pumps with the purpose of diverting the flow of drilling fluids towards the drill line or drill string. An adjustable choke can be installed to bleed pressure off the drillpipe, to reduce shock when breaking circulation in wells where loss of circulation is a problem, and to bleed-off pressure between BOPs during stripping operations. Pressure ratings up to 7,500 psi are available.

- Diverts flow of drilling fluids
- Provided with pressure indicator/sensor and/or temperature indicator/sensor
- Supplied free-standing or with support frame
- Range of configurations/capacities/specifications available
- Custom single or dual designs

Cement manifolds

Cameron cement manifolds are designed and manufactured to customer requirements and are fully certified in accordance with the recognized oilfield equipment standards.

The cement manifold is installed downstream of the cement unit with the purpose of diverting the flow of cement slurry during cementing operations. Pressure ratings up to 20,000 psi are available.

- Diverts flow cement
- Installed downstream of cement unit
- Provided with pressure indicator/sensor and/or temperature indicator/sensor
- Supplied free-standing or with support frame
- Hammer union or flanged connections
- Range of configurations/capacities/specifications available



Mud gas separator (MGS)

Cameron mud gas separators are designed and manufactured to customer requirements and are fully certified in accordance with the recognized oilfield equipment standards.

Mud gas separators are installed and used to separate and safely vent large pockets of gas from the active drilling mud system. The mud is routed to solids control equipment for further processing while the free gas is discharged through the gas exhaust pipe and travels through the flare line to be safely vented.

- Separate gas from drilling fluid
- Install downstream of well control choke
- Install in flow line if high-gas concentrations
- Excellent for underbalanced drilling
- Range of configurations/capacities available
- Custom design with capacity calculations

Glycol injection unit

Cameron glycol injection units are designed and manufactured to customer requirements and are fully certified in accordance with the recognized oilfield equipment standards.

The glycol injection unit works by pumping glycol into the manifold in order to prevent the formation of hydrates that can block flow lines. Injection occurs upstream of the manifold chokes. Current available sizes are 198.13 gallons (750 liters) or 264.17 gallons (1,000 liters) with outputs greater than 0.26 gal/min (1 L/min).

- Stainless steel enclosure
- Range of capacities and specifications available
- Easily integrated with control equipment
- Maintenance friendly

Manifold control system

Cameron manifold control systems are designed and manufactured to customer requirements and are fully certified in accordance with the recognized oilfield equipment standards.

Cameron manifold controls range from a simple single or dual choke control panel to custom design control systems. Custom designs include control of chokes, valves, and position indication with readout for choke upstream, choke downstream, standpipe and cement pressures/temperatures and pump stroke counter display. Handoff to DCS is often a desired feature that Cameron incorporates into its custom panels. PLC/HMI is also available.

- Reliable, economical, onshore or offshore application
- Range of instrumentation packages
- Design to fit in drillers cabin or on rig floor
- Range of configurations/capacities/specifications available

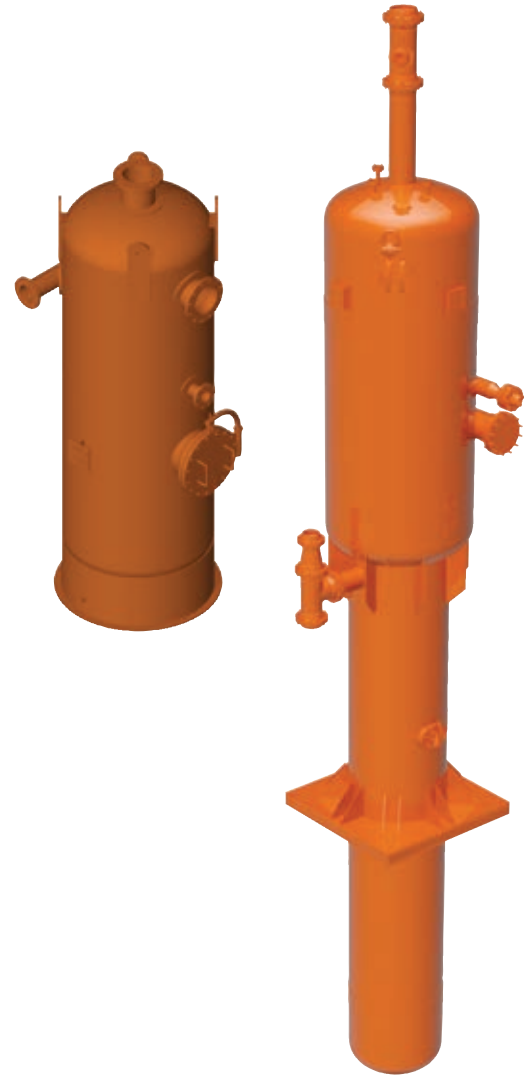

Mud gas separators



Valves

Cameron offers a wide range of valves to control and direct the flow of oil and gas from the drillfloor to the end user.

MCS gate valves

The Cameron MCS subsea gate valve is a compact valve suited for the rugged requirements of subsea choke-and-kill lines in water depths up to 10,000 ft (3,048 m).

The valve is hydraulically actuated. The detachable actuator requires only 6 in of clearance for removal without requiring removal of the valve from the line. The bonnet, packings, and stem remain in the valve when the actuator is removed.

Balanced stem prevents fluid displacement and prevents opening when line pressure is less than sea pressure. The exposed balancing stem allows visual indication of gate position. Bi-directional sealing allows valves to be spaced closely without liquid lock.

The one-piece seats and slab gate minimize cavity parts which simplifies maintenance.

- Size: 3-1/16 in (other sizes available upon request)
- Working pressure: 15,000 psi (other pressures available upon request)
- Operating temperatures: 0 to 350 degF (-18 to 176 degC)
- Operating pressure: 1,500 to 3,000 psi
- Variety of trims available
- Metal-to-metal sealing
- Compliant with API 6A, DNV, ABS, etc.
- Locking screw option available

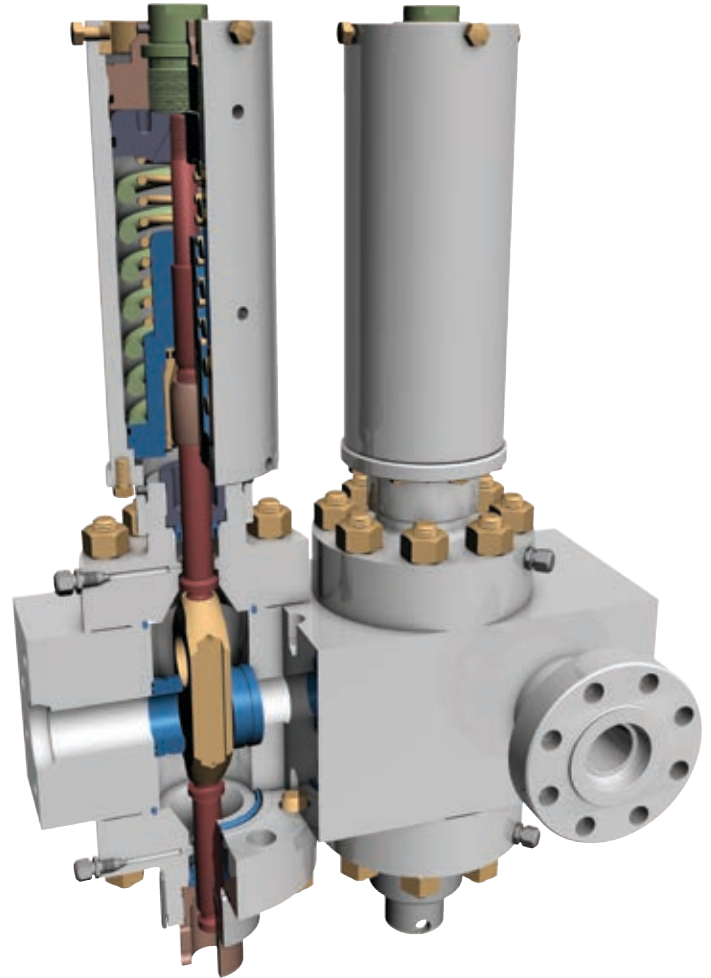

FLS gate valves

The Cameron FLS* gate valve is a full-bore, through-conduit valve available in standard double-flange, threaded-end and special block body configurations. It is a forged valve available in pressure ratings from 2,000 psi to 20,000 psi and bore sizes from 1-¹³/₁₆ in to 11 in. As Cameron standard valve, the FLS gate valve can be fitted with a wide range of Cameron actuators.

The FLS gate valve's bi-directional design provides flow direction versatility and maximum service life. Featuring metal-to-metal sealing (gate-to-seat and seat-to-body), the valve's simple, reliable gate and seat design promotes ease of field service and minimal spare parts inventory. Two spring-loaded, pressure energized, non-elastomeric lip-seals between each seat and body assist in low-pressure sealing. They also protect against intrusion of particle contaminants into the body cavity and seal areas.

The valve's stem seal design covers a full range of pressures, temperatures and fluids encountered in wellhead and manifold service. The stem can be back seated to allow stem seal replacement with the valve under pressure.

For more information on Cameron gate valves, please reference *API 6A Gate Valves brochure* (SUR-1024).

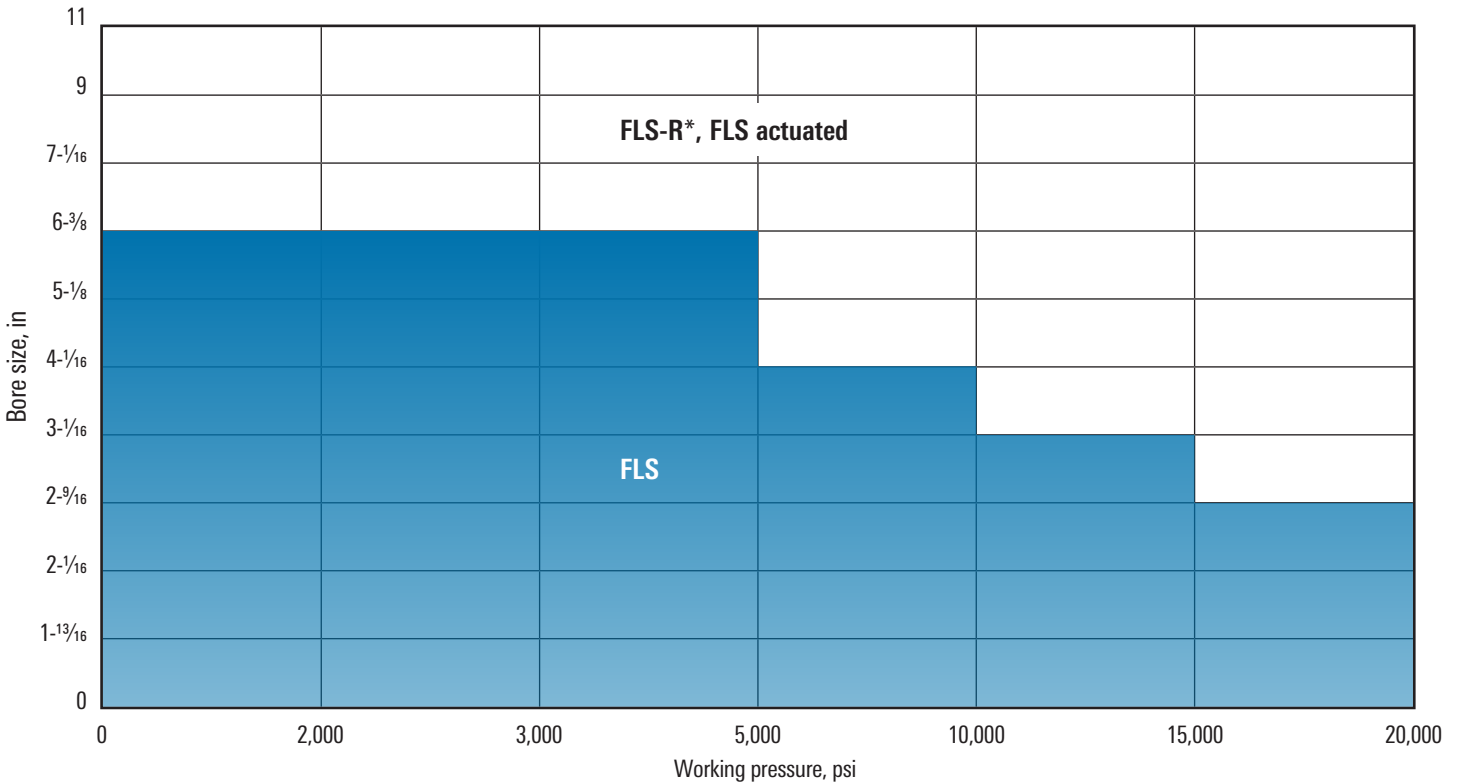

DRILLING EQUIPMENT





HMI and Controls Systems

Cameron delivers a complete range of drilling control rooms, advanced X-COM* operator chairs, drilling instrumentation systems, and monitoring systems for multiple types of offshore drilling applications. All software, inclusive of our HMI, machine controls, and integration functions for the zone management and tubular interlock systems are tested in a 3D simulation environment before installation on the rig. Our systems feature high-quality software and easy-to-use screen graphics, and our secure and efficient network is capable of interfacing with equipment from third-party vendors.

Drilling control room

Cameron delivers a range of drilling control rooms (DCRs) to the drilling industry. Our product offerings range from compact one-seater cabins to large well-construction centers, able to house essential drilling control and monitoring equipment, as well as several operators and any additional auxiliary equipment and personnel.

- Self-supporting carbon steel unit (optional stainless steel)
- Integrated X-COM designed for 1 to 5 X-COM operator chairs
- Large windows with fully-automatic window-cleaning system programmed for different weather conditions
- Removable, easy-to-clean, non-slip floor tiles
- Recessed ceiling with noise dampening
- Two safety/emergency exits
- Sun-filtered safety windows with protection bars and grids to protect the top windows from falling objects and the front windows and DCR from moving objects
- Tailored to drillfloor layout
- Ergonomically designed to meet the highest standards
- Wall space for BOP/auxiliary panels
- HVAC systems
- Range of additional options to meet customer specifications

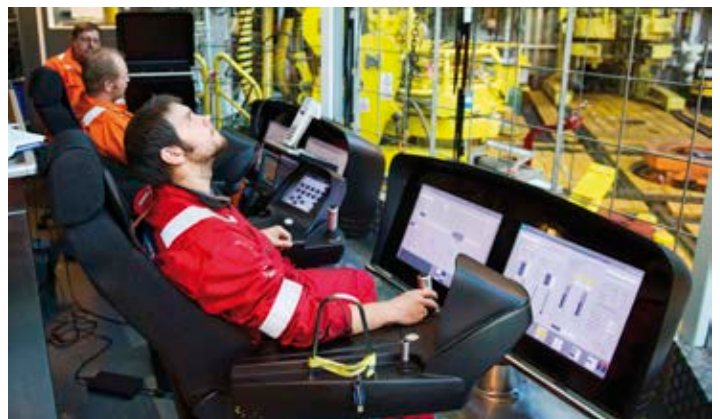

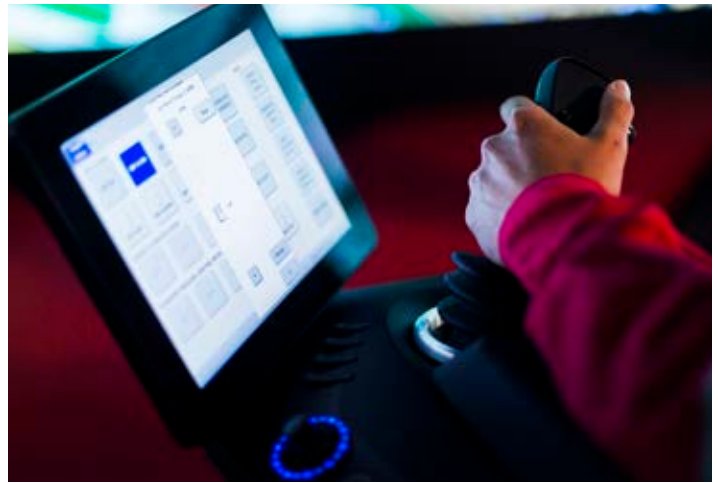

X-COM operator chair

- Simple and intuitive user interface
- Sunlight readable and dimming in all conditions
- Designed in accordance with NORSOK and international standards
- Outstanding ergonomic adjustments for maximized comfort and efficiency
- Slim and robust industrial design
- Safe technical components and internal redundancy
- Rapid placement of pluggable components allows for stress-free service and maintenance
- Includes 3 HMI front screens for closed circuit television (CCTV) and HMI
- Integrated CCTV and talkback system interface
- Excellent line of sight due to the chair's slim design



Local equipment room/local instrument room

- Self-supporting steel structure, with insulation and entrance door
- Rated for installation in Hazardous area Zone II (safe by ventilation)
- Removable antistatic floor tiles
- Complete delivery (including control system components, power distribution and lighting)
- HVAC system with heating/cooling units for temperature control
- Air handling unit with fire dampers and overpressure control
- Prepared interface for external systems (fire and gas system, HVAC, and rig control system)

OnTrack System

With the Cameron OnTrack* integrated drilling controls system, various types of drilling equipment and processes can be integrated into one system. This provides the driller and assistant driller with optimal monitoring and controls, along with key decision-making information.

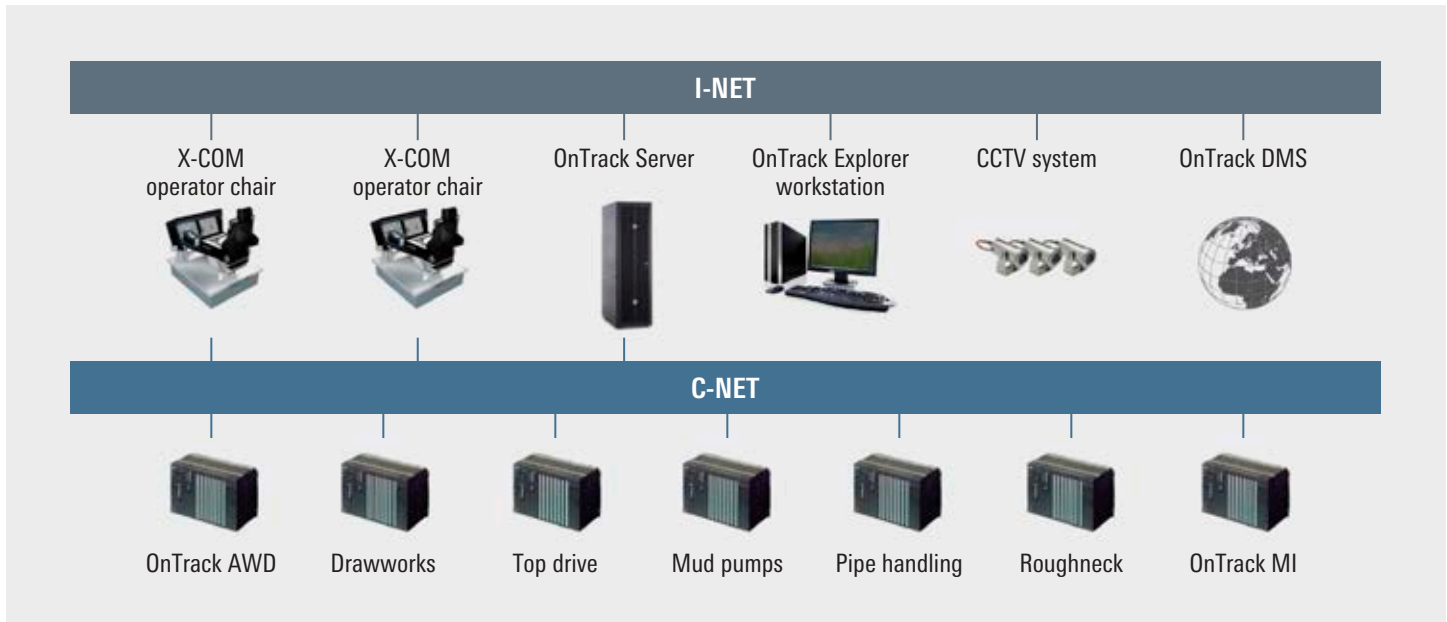

OnTrack System integration

Cameron OnTrack system integration ensures that all control systems from other suppliers fit together correctly and are integrated properly.

- Open interfaces which allow real-time parameter settings from drilling optimization/reservoir models
- Capable of being interfaced with virtually any third-party system on the market
- Executes and documents signal tests before installation
- Plug-and-play connection and start up of the drilling control system at the yard

OnTrack C-Net and I-Net

The Cameron C-Net and I-Net consist of high-speed communications networks exchanging data points at high rates. The network is segregated into two segments in order to ensure that control signals are given priority.

OnTrack MI interface

The Cameron OnTrack MI machinery interface ensures inter-faceability with virtually any third-party system on the market.

OnTrack Explorer workstation

The Cameron OnTrack Explorer* drilling analysis workstation consists of an analysis application that is used to access real-time and historical data from the OnTrack Server.

OnTrack tubular interlock system

The Cameron OnTrack tubular interlock system evaluates the status of interacting equipment, generates a tubular interlock situation, and executes the following interlock actions: inhibits control function in control logic, inhibits notification to HMI system, and provides interlock message notification to the HMI system.

- Increases personnel safety and uptime
- Prevents unintentional drop of tubular

OnTrack ZMS system

The Cameron OnTrack ZMS zone management system enables communication with other systems to help detect and avoid collisions between drillfloor equipment.



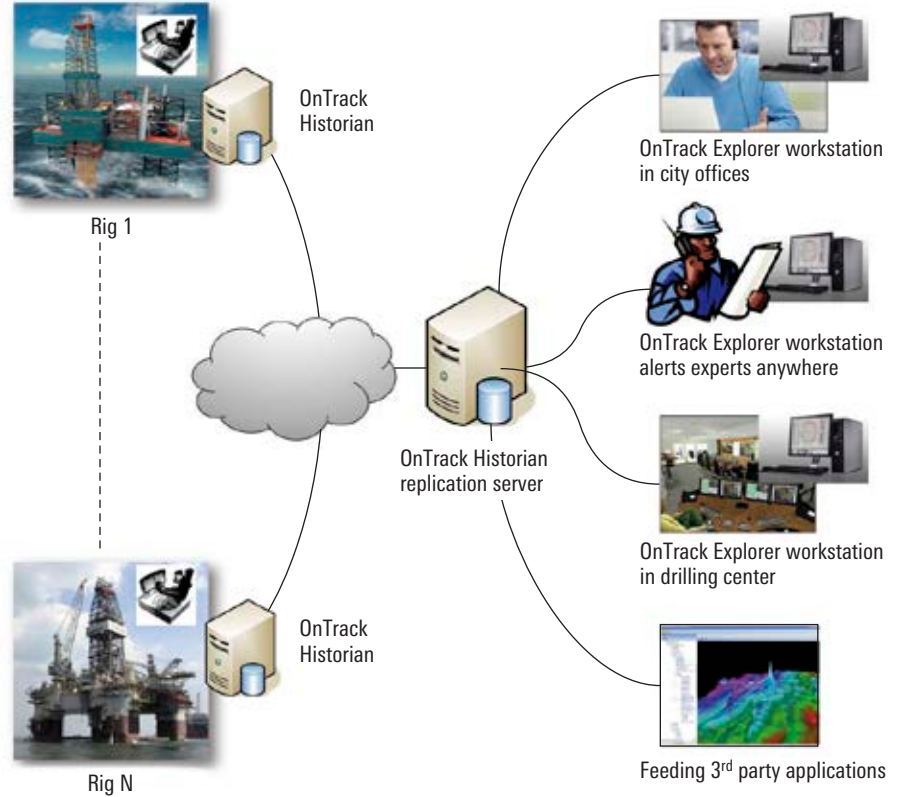

OnTrack DrillPilot

The Cameron OnTrack DrillPilot enables multiple drilling machines to be controlled by a single operator. With DrillPilot, the entire drilling operation acts as a complete system, rather than several individual machines. This simplifies operation and preparation for the operator compared with other conventional control systems.

- Reduces complexity for the operator
- All machines controlled by a single joystick
- Increases operational efficiency by reducing pipe handshake-time and providing more consistent tripping speeds
- Activates next step in operational sequences automatically, at the correct time
- Integrated setup wizards feature allows for faster setup and line-up of equipment for each type of operation (i.e., tripping or standbuilding)

Drilling parameter sensors

Cameron drilling parameter sensors allow for any type of sensor to be supplied as part of our package.

OnTrack SoftTorque

The Cameron OnTrack SoftTorque consists of anti-stick-slip software for the top drive.

- Eliminates stick-slip
- Improves well bore
- Reduces torque vibrations
- Reduces wear and tear on downhole tools
- Improves steerable system performance
- Reduced bit damage, longer bit runs

OnTrack DMS drilling management system

- Makes drilling data generated on the rig available anywhere
- Offers secure replication to onshore server
- Can be used with any internet location
- Can be fully interfaced on multiple rigs
- Incorporates the OnTrack Explorer workstation for operation and maintenance support
- Enables drilling data to be fed into other applications (i.e., maintenance system, reservoir model, etc.)
- Ultimately allows for "drill from the beach" capability

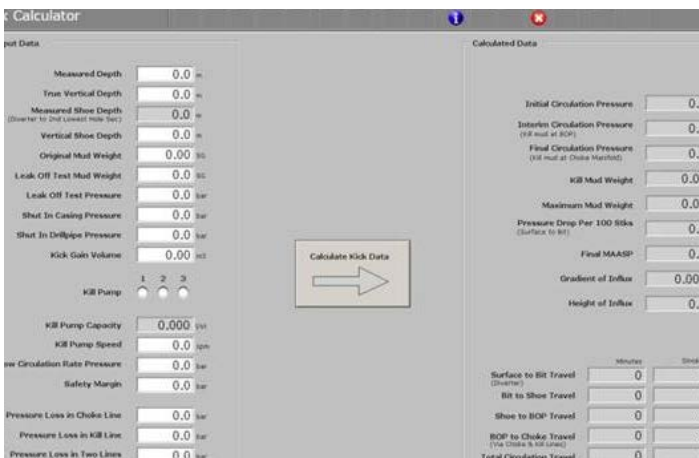
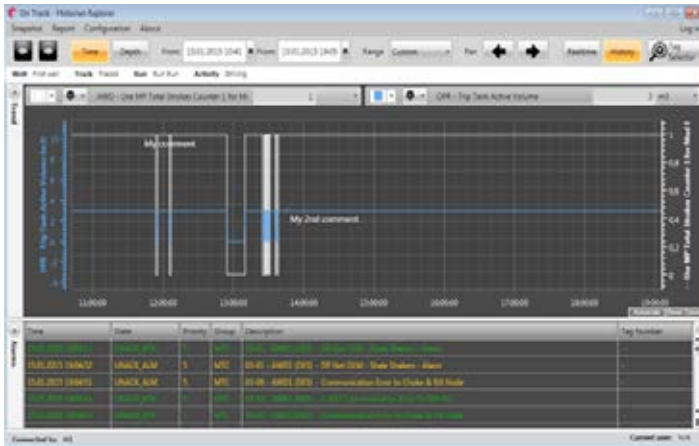

OnTrack Historian

The Cameron OnTrack Historian records all drilling activity, equipment, alarms, and events data generated on the rig in real-time to a time and depth series database. Historian components are integrated into the HMI for simple accessibility.

- Innovative method for storing all drilling data generated on the rig
- Records data based on the depth of the drilled hole
- Includes redundant data collectors on two physical servers to prevent loss of data in case of component failures
- Enables drilling data to be fed into other applications (i.e., maintenance system, performance logging, etc.)
- Allows user comments to be added to relevant alarm(s) and/or event(s)
- Allows for data retrieval from virtually anywhere via open protocols
- Optional secure replication of data to onshore server

OnTrack AWD analysis while drilling

The Cameron OnTrack AWD analysis while drilling consists of several real-time algorithms used to assist and guide the driller during drilling operations.

- Advanced drilling software that calculates numerous parameters such as:
 - Auto driller functions (i.e., weight on bit (WOB) and ROP)
 - Stands in hole
 - Bit runtime and depth
 - Hole depth
 - Drill string configuration
 - Mud tank volumes, mud flow and mud displacement
 - Kick calculator, kill sheet, annular mud velocity, etc.
- Integrated mud process control system and HMI
 - Provides mud control of tanks, pits, pumps, etc.
- Facilitates data transmission of AWD information to other consumers via standard protocols



Drawworks

Cameron offers AC gear-driven drawworks concepts for onshore and offshore applications. A wide range of models are available in single-speed or three-speed designs with up to 6,000-hp ratings. Cameron offers technically advanced gear-driven, active-heave drawworks systems with up to 11,200-hp ratings that are capable of compensating movements on large floaters and drillships.

LDW series

Cameron LEWCO* AC gear-driven drawworks offer technically advanced features to increase drilling performance, safety and reliability. The combination of both cost and operational efficiency with small footprints, less weight and reduced noise and vibration further adds to the advantages provided by these solid machines.

- Offered in 500/550K, 750K, 1000K, 1500K and 2000K hook load models
- Feature an engineered braking system for increased safety
- Achieve higher operational speeds (in all models) through the use of variable frequency drive (VFD) AC motors
- Require fewer utilities for installation and fewer spare parts

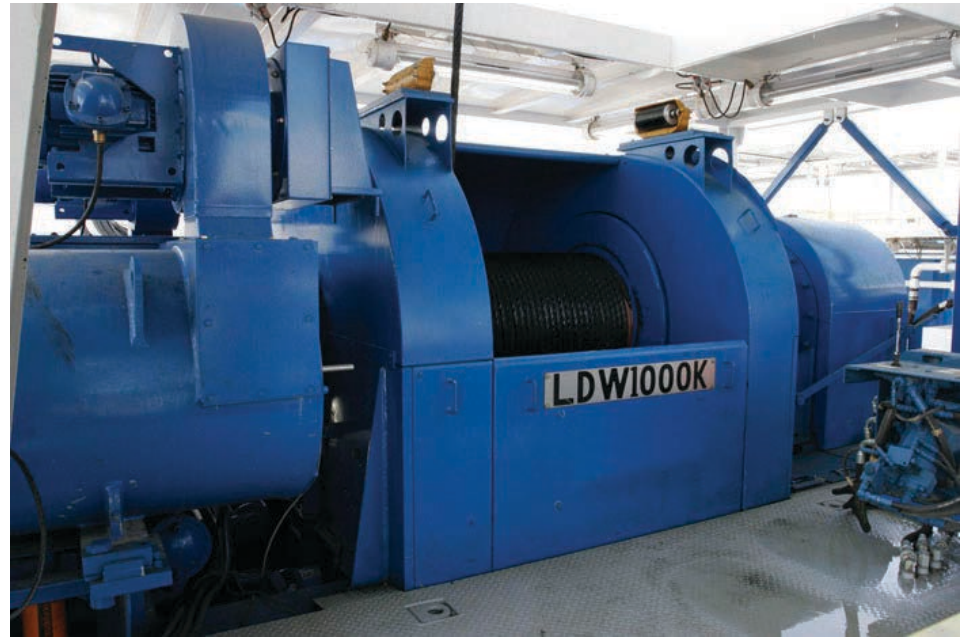

Model	Power rating DW duty, hp [kW]	Load, ton [tonne]	Block speed, ft/min [m/sec]	Gears	Motors	Lines
LDW 550K	1,500.00 [1,103.25]	275.00 [249.48]	238.19 [1.21]	1	1	10
LDW 750K	2,300.00 [1,691.65]	375.00 [340.19]	214.57 [1.09]	1	2	12
LDW 1000K	3,000.00 [2,206.50]	500.00 [453.59]	307.09 [1.56]	1	2	12
LDW 1500K	4,500.00 [3,309.74]	750.00 [680.39]	240.16 [1.22]	1	3	14

UltraHoist AHC series

The Cameron UltraHoist active-heave compensated (AHC) drawworks delivers safe and efficient hoisting and lowering during traditional drilling, tripping and handling operations, as well as accurate heave compensation during drilling or landing of the BOP to the seafloor. All UltraHoist AHC drawworks are gear-driven and available in three-speed or single-speed versions with power input from 4.5 hp to 9 hp and a load handling capacity of up to 1,250 ton (1,133.98 tonne).

- Lebus grooved drum for 2 in (50.8 mm) drill line—complete with kickback rollers and easily removable guards
- Easily removable cable anchor
- Control system interfaces with the Zone Management System via the C-NET network to enable communication with other system PLC, such as the anti-collision system
- Custom PLC software ensures smooth and natural operations for the driller
- Built-in, self-diagnostic functions automatically warn for service and overhaul of main components
- Onboard HPU systems for brakes and lubrications fitted with dual pumps and motors
- Internal gearboxes use a keyless design to avoid stress configurations
- Fail-safe braking system comprised of two brake discs, one at each side of the drum, and two calipers with brake pads acting on each disc
- Braking capacity of the emergency brakes equal to 200% of maximum line pull
- Automatic brake monitoring system, including brake slip detection, drum creep detection and drum response detection
- Integrated crown and floor saver provides full control of the various braking systems



Model	Power rating DW duty, hp [kW]	Load, ton [tonne]	Block speed, ft/min [m/sec]	Gears	Motors	Lines
UH SG 750-5600—AHC	5,600.00 [4,118.79]	750.00 [680.39]	326.77 [1.66]	1	4	14
UH SG 1250-11200—AHC	11,200.00 [8,237.59]	1,250.00 [1,133.98]	344.49 [1.75]	1	8	16
UH 3G 750-7300—AHC	7,300.00 [5,369.14]	750.00 [680.39]	393.70 [2.00]	3	4	14
UH SG 1000-8400—AHC	8,400.00 [6,178.19]	1,000.00 [907.18]	344.49 [1.75]	1	6	16

UltraHoist drawworks

The Cameron UltraHoist* offshore drawworks delivers efficient hoisting and lowering during drilling, tripping and handling operations. All UltraHoist drawworks are AC and gear-driven. The three-speed version offers operational flexibility, both at high speeds and high loads. The Cameron UltraHoist drawworks is also simpler to use, and integrates many safety features that are not currently offered by other models.

- Three-speed transmissions used between AC motors and fixed speed gearbox provide unique, fast line speed and pull characteristics
- Lebus grooved drum for 1-½ in (38.1 mm) (or 1-⅝ in (41.28 mm)) drill line—complete with kickback rollers and easily removable guards
- Easily removable cable anchor
- Control system interfaces with the Zone Management System via the C-NET network to enable communication with other system PLC, such as the anti-collision system
- Custom PLC software ensures smooth and natural operation for the driller
- Built-in, self-diagnostic functions with automatic warning system for service and overhaul of main components
- Onboard HPU systems for brakes and lubrications fitted with dual pumps and motors

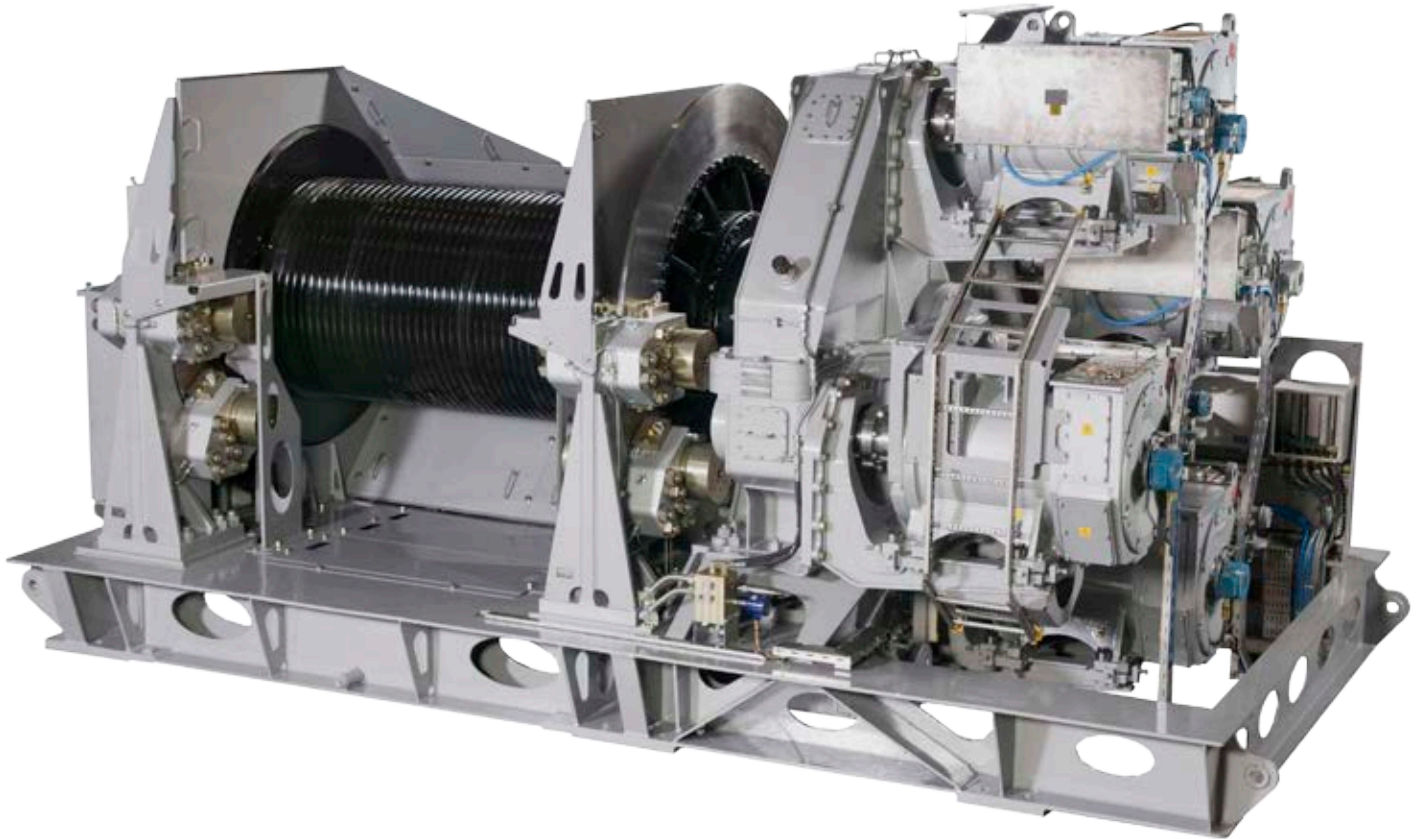

Model	Power rating DW duty, hp [kW]	Load, ton [tonne]	Block speed, ft/min [m/sec]	Gears	Motors	Lines
UH 3G 500-3000	3,000.00 [2,206.50]	500.00 [453.59]	393.70 [2.00]	3	2	12
UH 3G 650-3000	3,000.00 [2,206.50]	650.00 [589.67]	393.70 [2.00]	3	2	12
UH 3G 750-3660	3,660.00 [2,691.93]	750.00 [680.39]	393.70 [2.00]	3	2	14
UH 3G 1000-5600	5,600.00 [4,118.79]	1,000.00 [907.19]	393.70 [2.00]	3	4	16
UH 3G 1250-5600	5,600.00 [4,118.79]	1,250.00 [1,133.98]	393.70 [2.00]	3	4	16
UH SG 750-4500	4,500.00 [3,309.74]	750.00 [680.39]	275.59 [1.40]	1	3	14
UH SG 1000-6000	6,000.00 [4,412.99]	1,000.00 [907.19]	236.22 [1.20]	1	4	16
UH SG 1250-7300	7,300.00 [5,369.14]	1,250.00 [1,133.98]	236.22 [1.20]	1	4	16

Note: DW pull force to be limited to drill line size/type used

Hoisting Equipment

Cameron provides a range of high-performance hoisting equipment designed to enhance safety and reduce maintenance.



Traveling block

- 500-, 650-, 750-, 1,000- and 1,250-ton (453.59-, 589.67-, 680.39-, 907.19- and 1,133.98-tonne) models available
- Simple and sturdy design
- Easy access to lubrication and greasing points
- High-quality, durable components
- Bondura bolts as clevis pins



Deadline anchor

- Designed for ease of service and maintenance
- Drum design enables easy slip-and-cut
- Adjustable wire outlet direction allows for both floor and derrick leg mounting
- Dual strain gauge in load cell
- Handy service pocket



Drill line storage reel

- Robust frame/skid for drum carriage
- Quick change of drum
- Robust pinion/cog wheel transmission for drilling line spooling
- Hydraulic drive to ease slip-and-cut operations; hydraulic drive also serves as brake when not in operation



3000 LBS (1360 KG) Capacity
5000' (1524 M) Reach
CRAWLER CRANE
CAMERON

Top Drive Systems

Cameron offers a range of 500-ton (453.59-tonne) to 1,250-ton (1,133.98-tonne) AC-driven top drive systems for demanding drilling applications. All of our top drives come with several accessories that have been tailor-made to meet rig requirements. High quality components, modularity to reduce maintenance and down time, as well as reliable gearboxes, controls, and automation make Cameron top drives the preferred choice for any drilling crew.





TD 1500-AC-2M, TD 1250-AC-2M, TD 1000-AC-2M



TD 750-AC-1M, TD 650-AC-1M, TD 500-AC-1M



750-AC-1M-C

Features

- High-capacity thrust bearing
- Helical-cut gear teeth (carbured and grinded) increase service life and reduce noise level and maintenance
- Gearbox lubrication ensures optimal conditions for gears and bearings under all environmental conditions
- Self-calibrating thread compensation system uses analogue stroke sensor to optimize performance
- Bell housings between AC motors and gearbox provide precise alignment as well as protect the flexible coupling between motor output shaft and gearbox pinion shaft
- High-capacity knuckle link tilt system allows handling of latest model of «fail-safe» elevator—from drilling to maximum kickout mode
- Wash pipe can be replaced within minutes
- Rotary head with 18 ports
- Programmable arbitrary stop positions for the pipehandler rotate function allow the driller to set a number of predefined elevator open positions
- Customized PLC software provides easy, accurate and natural operator controls from a single point
- Noise reduction
- Dual retention of all fasteners
- Torque wrench design eliminates risk of accidental break out of drillstem subs

	TD 1500-AC-2M	TD 1250-AC-2M	TD 1000-AC-2M	TD 500/650/750-AC-1M	TD 750-AC-1M-C
Drive type	AC	AC	AC	AC	AC
Capacity in elevator	1,500.00 ton [1,360.78 tonne]	1,250.00 ton [1,133.98 tonne]	1,000.00 ton [907.19 tonne]	500.00 ton/650.00 ton/700.00 ton (453.59 tonne/589.67 tonne/ 635.03 tonne)	750.00 ton [680.39 tonne]
Power rating	2,300.00 hp/3,000.00 hp [1,691.65 kW/2,206.50 kW]	2,300.00 hp [1,691.65 kW]	2,300.00 hp [1,691.65 kW]	1,150.00 hp [845.82 kW]	1,150.00 hp [845.82 kW]
Motors	2	2	2	1	1
Continuous torque	120,000.00 ft-lb/157,000 ft-lb [162,698.15 N·m/212,863.42 N·m]	98,000.00 ft-lb [132,870.16 N·m]	98,000.00 ft-lb [132,870.16 N·m]	66,000.00 ft-lb [89,483.98 N·m]	66,000.00 ft-lb [89,483.98 N·m]
Maximum speed	250 rpm	274 rpm	274 rpm	263 rpm	263 rpm
Torque at maximum speed	40,000.00 ft-lb [54,232.72 N·m]	43,900.00 ft-lb [59,520.40 N·m]	43,900.00 ft-lb [59,520.40 N·m]	17,500.00 ft-lb [23,726.81 N·m]	17,500.00 ft-lb [23,726.81 N·m]
Speed at maximum torque	100 rpm	123 rpm	123 rpm	91 rpm	91 rpm
Maximum breakout torque	147,000.00 ft-lb/220,000 ft-lb [199,305.24 N·m/298,279.95 N·m]	125,000.00 ft-lb [169,477.24 N·m]	125,000.00 ft-lb [169,477.24 N·m]	115,000.00 ft-lb [155,919.06 N·m]	99,000 ft-lb [134,225.98 N·m]
Mud line path	4.00 in [101.60 mm]	3.25 in [82.55 mm]	3.25 in [82.55 mm]	3.25 in [82.55 mm]	3.25 in [82.55 mm]
Water course pressure rating	7,500.00 psi [517.11 bar]	7,500.00 psi [517.11 bar]	7,500.00 psi [517.11 bar]	7,500.00 psi [517.11 bar]	7,500.00 psi [517.11 bar]
IBOP standard	20,000.00 psi [1,378.95 bar]	15,000.00 psi [1,034.21 bar]	15,000.00 psi [1,034.21 bar]	15,000.00 psi [1,034.21 bar]	15,000.00 psi [1,034.21 bar]

Vertical Pipe Handling Systems

Cameron delivers a full range of high-performance vertical pipe handling solutions for a variety of offshore applications. Our product offering includes triple and quad SmartRacker vertical pipe-handling systems, two-arm systems, double and triple X-Rackers and fingerboards, handling everything from singles to quadruple stands in a safe and efficient manner.

SmartRacker IV-P and SmartRacker III-P systems

Cameron SmartRacker* systems fulfill any pipe handling functions on a modern drillfloor. With their main functions driven by AC technology, our SmartRacker systems perform tripping and standbuilding safely and efficiently. The design includes advanced features, but is simple to use and produces smooth and accurate movements.

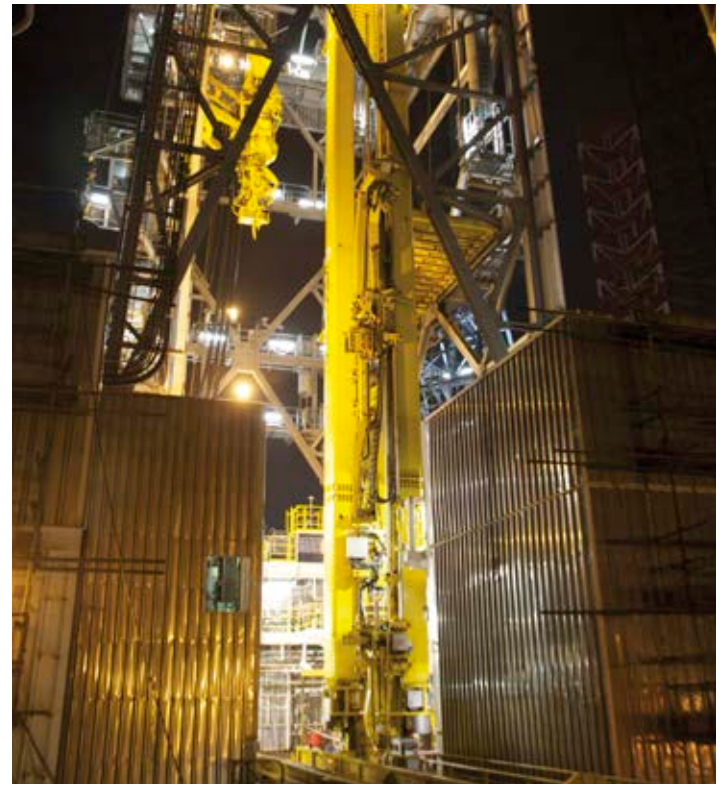

	SR IV-P	SR III-P	SR III-XY
Racking arrangement	Parallel	Parallel	Parallel
Stand type	Quad	Triple	Triple
Tubular maximum length	135.00 ft [41.15 m]	96.00 ft [29.26 m]	96.00 ft [29.26 m]
Number of arms (guide/lift)	2G/1L	1G/1L	1G/1L
Guide arms vertical movement	6.56 ft [2.00 m]	6.56 ft [2.00 m]	—
Lower guide arm vertical movement	11.48 ft [3.50 m]	11.48 ft [3.50 m]	—
Upper guide arm vertical movement	29.53 ft [9.00 m]	29.53 ft [9.00 m]	—
Drive type (lift/turn/sideways)	AC	AC	Hydraulic
Lifting capacity	16.53 ton [15.00 tonne]	11.02 ton [10.00 tonne]	11.02 ton [10.00 tonne]
Maximum reach	16.90 ft [5.15 m]	16.90 ft [5.15 m]	15.09 ft [4.60 m]
Rotation	360 degree	360 degree	225 degree
Gripper head pipe range	3.50–14.00 in [88.90–355.60 mm]	3.50–14.00 in [88.90–355.60 mm]	3.50–9.75 in [88.90–247.65 mm]
Pick up elevator pipe	2.88–14.00 in [73.15–355.60 mm]	2.88–14.00 in [73.15–355.60 mm]	2.88–75 in [73.15–247.65 mm]



BridgeRacker*

- Suitable for drillships or jack-ups
- Extremely compact design
- 11.02 ton (10 tonne) lifting capacity
- 9.84 ft (3 m) lifting height
- Handles pipe from 3-½ to 14 in (88.9 to 355.6 mm) in size
- Easily retrofittable, due to limited integration needed with derrick and control system
- Can be controlled from portable operator panel

SmartRacker XY system

- Versatile for handling of triple stands, horizontal-to vertical, as well as assistance in handling smaller bits, subs and objects
- Fully-automated functions with focus on extremely simple use
- All main functions driven by hydraulic motors
- One gripper head handles all drillpipe, casing and drill collar from 3-½ to 9-¾ in (88.9 to 247.65 mm) (2-⅞ in (73.03 mm) optional)
- Accurate soft stabbing function saves threads on drillpipes
- Works in concert with the SmartCat* catwalk machine for horizontal-to-vertical operations; no need for overhead v-door machines
- Pickup elevator with fail-safe mechanical lock range from 2-⅞ to 9-¾ in (73.03 to 247.65 mm) pipe size
- Robust design with few well-protected sensors
- User-friendly HMI with onscreen operator guidance



Fingerboards

Cameron delivers various types of fingerboards. All fingerboards are tailor-made with respect to storage capacity, dynamic considerations, interfaces, options and choice of remote control or automated functionality.

Horizontal Pipe Handling Systems

Cameron delivers a full range of high-performance horizontal pipe handling solutions for a variety of offshore applications. Our product offerings include catwalk machines, conveyers, feeding tables, pipe deck cranes and tail-in arms that handle everything from drillpipe to casing and marine risers in a safe and efficient manner. Cameron delivers both tailor-made, standalone equipment and complete systems designed for tripping and offline standbuilding of casing and drillpipe while drilling. Cameron has a range of products that can be used to optimize pipe handling through rig upgrades as well as new builds.





Catwalk

The Cameron catwalk machine runs horizontal from the pipe rack area onto the drillfloor to deliver and pick up singles of drillpipe, drill collars, and casing as well as smaller items such as subs, bits, and pumps.

- Horizontal handling of all drillpipe improves overall safety and ease of operation
- Tail-in-arm for guiding pipe to and from vertical position
- Fully-automated system that can be interfaced with other machines on the drillfloor
- Twin skate travel motors, gears, and brakes
- Fail-safe design philosophy
- Transport frame with 33.07 ton (30 tonne) capacity

Riser catwalk

The riser catwalk machine runs horizontal from the riser rack area onto the drillfloor to deliver and pick up risers.

- Versatile to accommodate various drillfloor layouts, with a skate capable of up to 131 ft (39.93 m) of horizontal travel
- Uplift unit designed to lift the front end of the risers in order to accommodate for various riser gimbal heights
- Tail in unit, for tail-in of risers, built into the skate
- Includes transport frame with 55.12 ton (50 tonne) lifting capacity, which allows for of various pieces of equipment (i.e., spider, gimbal, etc.) to and from the drillfloor
- Fully-automated system that can be interfaced with other machines on the drillfloor

Pipe Deck Crane

The Cameron pipe deck crane is designed as an advanced stand-alone system for horizontal handling of tubular between the pipe deck and the tubular catwalk machine. The crane is a knuckle-boom type crane with a circular pedestal, specially designed to have a simple interface and large operating envelope.



Pipe deck crane, knuckle boom with «JibLink»

- Knuckle boom for direct connection with the load
- Lightweight and cost-efficient «JibLink» design provides wider operating envelope without the need for any telescope in the jib
- Lifting capacity of 5.51 ton (5 tonne)
- Wide operating radius: 8.2 ft to 85.3 ft (2.5 m to 26 m) reach
- Handles pipe with up to 20 in (508 mm) diameter and 45 ft (13.72 m) length
- Simple, low-maintenance gripper yoke
- LED floodlights
- Onboard HPU

Optional:

- Operator cabin with HVAC
- CCTV in gripper head
- Winch

Pipe deck crane, knuckle boom

- Knuckle boom for direct connection with the load (no wires or swinging load)
- Lifting capacity range of 5.51 ton to 38.58 ton (5 tonne to 35 tonne)
- Operator-friendly cabin
- Onboard HPU

Optional:

- Telescopic jib
- Winch
- Various gripper yoke designs available

Drillfloor Pipe Handling Equipment



Drillfloor manipulator arm

- Versatile arm installed under guide rails or other suitable locations
- Accommodates tubular ranging from 2.88 to 47 in (73.15 to 1,193.8 mm)
- Telescoping range of 17.06 ft (5.2 m)
- 180-degree swing
- 1,322.77 lb (600 kg) extended lifting capacity



Floor handling arm

- Versatile handling arm can be placed on drillfloor or cellar deck
- Adapter for gripper or work basket
- Lifting capacity of up to 6.61 ton (6 tonne) at 8.2 ft (2.5 m)
- Maximum reach for guiding of 28.54 ft (8.7 m)
- 360-degree swing



Mouseholes

The main function of the mousehole is to hold tubulars during standbuilding or stand breakdown. Mouseholes are designed to utilize the area below drilling, and are flush-mounted with the drillfloor upon installation.

Available in various designs:

- Fixed
- Telescopic
- Rotating
- Colt
- Rabbit
- Rotary-mounted fixed

All types can be equipped with the following:

- Hydraulic or spring-powered centralizer
- Patented shock absorbing system
- Mud drain system

Hydraulic Roughnecks

Cameron delivers high-performance hydraulic roughnecks including the patented JiM 20 large-tubular hydraulic roughneck, one of the most advanced hydraulic roughnecks on the market, capable of handling tubulars from 2-7/8 to 20 in (73.15 to 508 mm). The JiM 20 hydraulic roughneck features a six-grip drive ring that transmits torque accurately onto the tool joint with a built-in pipe dozer and mud bucket. The JiM 20 hydraulic roughneck is fully automated and can transmit torque/turn data directly to «the beach» in real time.

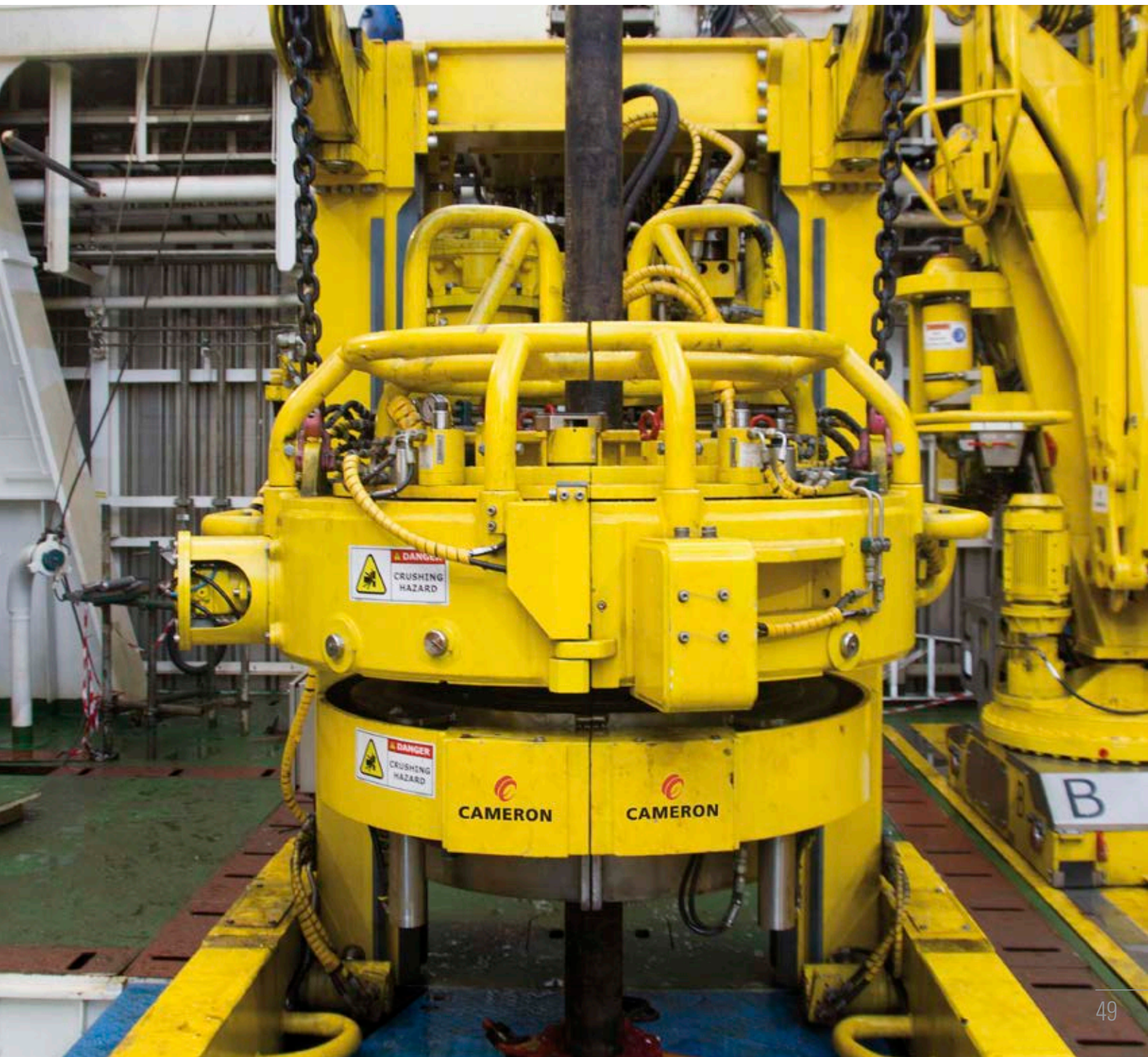

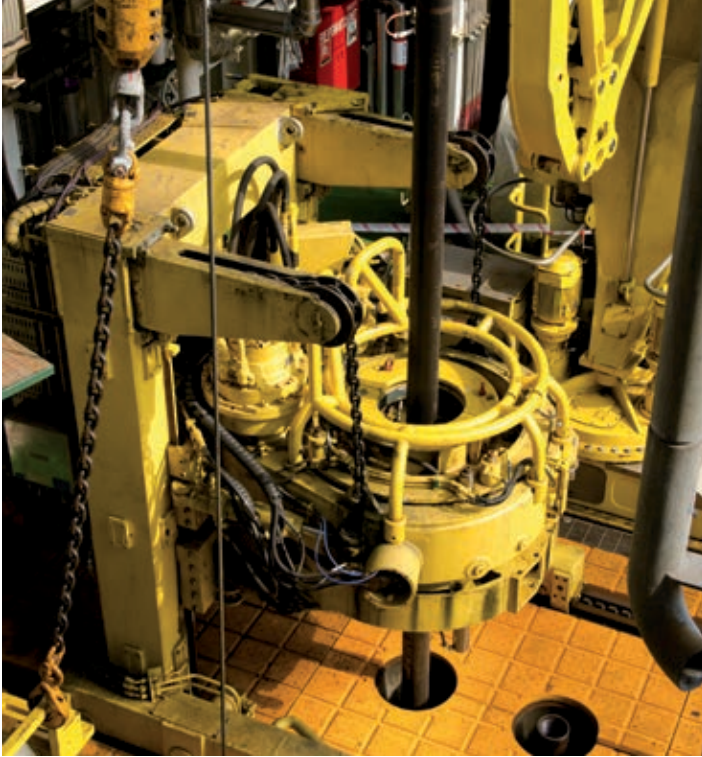

JiM 20

The Cameron JiM 20 hydraulic roughneck embraces a complete equipment package to perform jointing operations on all tubular pipes used for drilling, casing, and completing the well.

The JiM 20 hydraulic roughneck handles spinning, make up and break out of all drillpipes, drill collars, casing and tubing—from 2- $\frac{3}{8}$ in (60.45 mm) drillpipe to 20 in (508 mm) casings—by changing jaw inserts. Roughneck tubing tongs and casing tongs are replaced with the JiM 20 hydraulic roughneck.

- Unique split driving design for continuous rotation
- Six mechanically-synchronized dies in each jaw
- Extreme torque capability of up to 184,390.54 ft-lb (250 kN-m)
 - Bit breaking at full torque
 - Top drive backup at full torque
- Integrated cleaning and doping system
- Integrated mud bucket
- Allows for quick changes between drillpipe and casing modes (approximately 14 minutes)





JiM 10

The design of the Cameron JiM 10 hydraulic roughneck delivers a cost-effective, modern hydraulic roughneck in a compact format. Featuring an advanced control system, the JiM 10 hydraulic roughneck keeps safety in mind and is a sensible choice for today's demanding drilling needs.

The Cameron JiM 10 hydraulic roughneck is an advanced system for make up and break out of drillpipe and drill collars, engineered for a tubular range of 3- $\frac{1}{2}$ to 10 in (88.9 to 254 mm). The JiM 10 hydraulic roughneck features a torque wrench in an articulated arm, allowing the torque wrench and spinner assembly to travel from parked position to well center. The elevation system ensures that the JiM 10 hydraulic roughneck is capable of handling a wide range of stick ups with ease and high precision. Additionally, casing modems are available for the JiM 10 hydraulic roughneck.

- Compact design
- Triple-grip torque wrench with integrated clamp cylinders
- Powerful spinner (3,466.54 ft-lb (4.7 kN-m)) with high-grip rollers
- Synchronized clamps
- Smart clamp system with adjustable clamp pressure
- Short (T-P) or long (T-P-L) reach models available
- High make up and breakout torque of 103,258.7 ft-lb to 147,512.43 ft-lb (140 kN-m to 200 kN-m)

Model code	GR01	GR02	GR03
Product model	JiM 10 T-P	JiM 10 T-P-L	JiM 10 T-R
			
Diameter range, drilling tubular	3-½–10 in [88.90–254.00 mm]	3-½–10 in [88.90–254.00 mm]	3-½–10 in [88.90–254.00 mm]
Diameter range, casing and tubing	—	—	—
Torque capacity, make up	103,258.70 ft-lb [140.00 kN·m]	103,258.70 ft-lb [140.00 kN·m]	103,258.70 ft-lb [140.00 kN·m]
Torque capacity, break out	103,258.70 ft-lb [140.00 kN·m]	147,512.42 ft-lb [200.00 kN·m]	147,512.42 ft-lb [200.00 kN·m]
Torque capacity, back up	—	—	103,258.70 ft-lb [140.00 kN·m]
Torque capacity, bit breaking	—	—	103,258.70 ft-lb [140.00 kN·m]
Spinner torque	3,466.54 ft-lb [4.70 kN·m]	3,466.54 ft-lb [4.70 kN·m]	3,466.54 ft-lb [4.70 kN·m]
Travel/extend range	75.59 in/94.69 in [1,920.00 mm/2,405.00 mm]	153.54 in/193.39 in [3,900.00 mm/4,912.00 mm]	275.59 in [7,000.00 mm]
Parked size (l × w × h)	4.62 ft × 4.43 ft × 8.50 ft [1.41 m × 1.35 m × 2.59 m]	7.41 ft × 5.12 ft × 8.96 ft [2.26 m × 1.56 m × 2.73 m]	6.30 ft × 6.30 ft × 8.30 ft [1.92 m × 1.92 m × 2.53 m]
Integrated mud bucket	No	No	No
Weight	5.40 ton [4.90 tonne]	8.71 ton [7.90 tonne]	8.71 ton [7.90 tonne]
Hazardous area classification	ATEX Zone 1	ATEX Zone 1	ATEX Zone 1
Class	ABS / DNV Class II	ABS / DNV Class II	ABS / DNV Class II

Model code	GR12	GR20		
Product model	JiM 10 M-P-L	JiM 20		
Configuration	CDT10	CCT9	CCT22	
				
Diameter range, drilling tubular	3-½–10 in [88.90–254.00 mm]	—	—	2-7/8–9-½ in [73.15–241.30 mm]
Diameter range, casing and tubing	—	2-3/8–9 in [60.45–228.60 mm]	9–22 in [228.60–558.80 mm]	5–22 in [127.00–558.80 mm]
Torque capacity, make up	103,258.70 ft-lb [140.00 kN·m]	25,077.11 ft-lb [34.00 kN·m]	81,131.84 ft-lb [110.00 kN·m]	184,390.54 ft-lb [250.00 kN·m]
Torque capacity, break out	147,512.42 ft-lb [200.00 kN·m]	25,077.11 ft-lb [34.00 kN·m]	81,131.84 ft-lb [110.00 kN·m]	184,390.54 ft-lb [250.00 kN·m]
Torque capacity, back up	—	—	—	184,390.54 ft-lb [250.00 kN·m]
Torque capacity, bit breaking	—	—	—	184,390.54 ft-lb [250.00 kN·m]
Spinner torque	3,466.54 ft-lb [4.70 kN·m]	Variable motor displacement	Variable motor displacement	8,850.75 ft-lb [12.00 kN·m]
Travel/extend range	157.48 in/208.66 in [4,000.00 mm/5,300.00 mm]	157.48 in/208.66 in [4,000.00 mm/5,300.00 mm]	157.48 in/208.66 in [4,000.00 mm/5,300.00 mm]	275.59 in [7,000.00 mm]
Parked size (l × w × h)	7.61 ft × 5.12 ft × 8.96 ft [2.32 m × 1.56 m × 2.73 m]	7.91 ft × 5.25 ft × 8.96 ft [2.41 m × 1.60 m × 2.73 m]	9.32 ft × 6.20 ft × 8.96 ft [2.84 m × 1.89 m × 2.73 m]	9.38 ft × 7.25 ft × 9.84 ft [2.86 m × 2.21 m × 3.00 m]
Integrated mud bucket	No	No	No	Yes
Weight	10.91 ton [9.90 tonne]	8.71 ton [7.90 tonne]	10.25 ton [9.30 tonne]	13.78 ton [12.50 tonne]
Hazardous area classification	ATEX Zone 1	ATEX Zone 1	ATEX Zone 1	ATEX Zone 1
Class	ABS / DNV Class II	ABS / DNV Class II	ABS / DNV Class II	ABS / DNV Class II

Drillfloor Tools

Cameron delivers a range of innovative drillfloor tools for a variety of offshore applications.



Hydraulic cathead

- Designed for easy service and maintenance
- Remote operation
- Pad eyes for backup tongs on swing sheave
- Valve cabinet for drillfloor installation
- Remote operation; no crew needed on floor during operation
- Fail-safe isolation valve



Work basket

- 551.16 lb (250 kg) basket capacity
- ± 45 -degree boom swing
- Hydraulic unit rated for Zone II operation
- Double-telescopic boom can be tilted or slewed
- Emergency stop on local and remote control panels



Mud bucket

- Long reach
- Handles wide range of stick ups
- Quick replacement of mud seal
- Quick connections on mud hose
- Emergency stop located in control stand



Rotary table

- Supplied with spiral-bevel, induction-hardened gears
- Include a forged-steel fabricated housing and a heat-treated forged-steel turntable
- Lever access from the top to lock the table in position



Utility winch

- Lifting capacity ranging from 1.1 ton to 16.53 ton (1 tonne to 15 tonne)
- Controlled from winch or optional remote control
- Certified to DNV Drilling Plant and ABS+CDS (other requirements available upon request)



Man-rider winch

- Compact and versatile man rider
- Controlled from winch or optional remote control
- Delivered in accordance with any approval and certificate requirement(s)
- Certified to DNV Drilling Plant and ABS+CDS (other requirements available upon request)



Back-up stabber

- Offers backup when making connections with high stick up
- Easily installed behind top drive guide rails
- Torque capacity of up to 88,500 ft-lb (119.99 kN·m)



Cellar Deck Equipment

Cameron delivers a complete range of BOP handling systems for semisubmersibles, drillships, platforms, and jack-ups. Our systems are designed and built with focus on easy maintenance, durability, and the ability to withstand even the harshest environments. Cameron provides solutions to meet our customer's requirements and specifications.

BOP handling equipment for platforms and jack-ups:

- BOP monorail hoists up to 137.79 ton (125 tonne)
- BOP overhead cranes up to 248.02 ton (225 tonne)
- BOP service cranes up to 38.58 ton (35 tonne)
- BOP fork cranes up to 137.79 ton (125 tonne)
- BOP trolleys (of various designs)
- BOP skids up to 248.02 ton (225 tonne)
- BOP tensioner cylinders
- X-mas tree skids up to 165.35 ton (150 tonne)
- X-mas tree skids with turn-table

BOP handling equipment for semisubmersibles and drillships:

- BOP/LMRP cranes up to 661.38 ton (600 tonne) (with or without BOP/LMRP guiding on pinned leg)
- AC BOP cranes with variable frequency drives (VFDs)
- BOP service cranes (of various designs)
- BOP forklift carriers up to 716.5 ton (650 tonne)
- BOP moonpool trolleys up to 1,102.31 ton (1,000 tonne)
- BOP skids (of various designs) up to 661.38 ton (600 tonne)
- BOP underhull guiding
- BOP/LMRP bulkhead guiding
- BOP/LMRP seafixing

Various cellar deck handling equipment:

- X-mas tree handling cranes up to 165.35 ton (150 tonne)
- X-mas tree skids up to 165.35 ton (150 tonne)
- X-mas tree stack-up guide
- X-mas tree guide arms
- Trip saver trolleys up to 1,102.31 ton (1,000 tonne)
- Test stump retraction unit
- Connector removal skid
- STiCS stab-in connection system
- MUX cable tensioning system

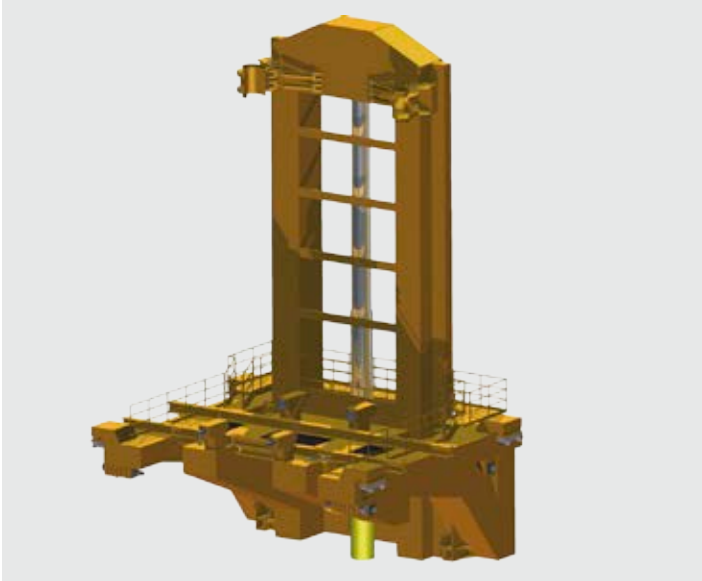

BOP handling equipment

- Skidding of BOP directly on to forklift
- Fully-guided BOP
- Integrated test stump retraction unit

BOP crane

- VFD-driven AC crane with pneumatic auxiliary hoists
- Emergency caliper brakes with 220% safe working load (SWL) braking force
- API 7K and DNV compliant



Casing guide

- Guides casing through the splash zone
- Eliminates casing stickup movement
- Increases casing running speed

Stab-in Connection System

The STiCS stab-in connection system safely and quickly connects heavy choke and kill hoses to the riser slip joint to save hours of rig time while reducing hazardous work above water. The operator remotely stabs and makes up all riser hose connections then stores and hides the hydraulic handling arms and actuators. Corrosion-resistant gooseneck connections remain fail-safe locked onto the riser.

For easy maintenance access, disconnection is done in reverse order by parking the hose/gooseneck assemblies at the side of the moon pool. Handling arms are mounted on the BOP trolley or moon pool structure. STiCS systems can be used with both in-line and wireline tensioners. The termination receptacles may be welded or clamped onto any telescopic joint.

- Eliminates hazardous work above open water by allowing the operator to safely connect or disconnect the goosenecks to/from the telescopic joint via a remote operated panel
- All hydraulic connections are located on the STiCS system executer assembly, no onboard hydraulics stay on the telescopic joint



STiCS system

Hydraulic Power Units

Cameron offers a line of hydraulic power units (HPUs), available in three-, four- and five-pump models, designed to the highest standard, with a focus on low noise, easy maintenance, and low life cycle cost.



- Stainless steel hydraulic fluid tank
- HPU skid supplied with vibration dampeners
- Continuous oil circulation system
- Offline fine-filter system
- Duplex main return and drain filter
- Individual pressure filter for main pumps
- Distribution manifold in the supply line
- Low and low-low level tank alarms
- High and high-high fluid temperature alarms
- Local operator panel provides start/stop control and running indications on all motors
- HPU skid equipped with four certified lifting eyes
- Pressure relief valve mounted in each main supply line
- Hydraulic soft start-up system

Model	Number of pumps	Operating pressure, psi [bar]	Required electric input power per pump, hp [kW]	Output flow per pump, gal/min [L/min]	Total output flow, gal/min [L/min]
HPU 1-210-94-240-240	1	3,000.00 [206.84]	126.00 [92.67]	63.40 [240.00]	63.40 [240.00]
HPU 2-210-94-240-480	2	3,000.00 [206.84]	126.00 [92.67]	63.40 [240.00]	126.80 [480.00]
HPU 3-210-94-240-720	3	3,000.00 [206.84]	126.00 [92.67]	63.40 [240.00]	190.20 [720.00]
HPU 4-210-94-240-960	4	3,000.00 [206.84]	126.00 [92.67]	63.40 [240.00]	253.61 [960.00]
HPU 5-210-94-240-1200	5	3,000.00 [206.84]	126.00 [92.67]	63.40 [240.00]	317.00 [1,200.00]
HPU 6-210-94-240-1440	6	3,000.00 [206.84]	126.00 [92.67]	63.40 [240.00]	380.41 [1,440.00]
HPU 7-210-94-240-1680	7	3,000.00 [206.84]	126.00 [92.67]	63.40 [240.00]	443.81 [1,680.00]
HPU 8-210-94-240-1920	8	3,000.00 [206.84]	126.00 [92.67]	63.40 [240.00]	507.21 [1,920.00]



Noise hood

- Access doors for easy maintenance
- Removable
- Entire HPU can be lifted (including noise hood)
- Stainless steel construction

Motion Compensation Equipment

Cameron delivers motion compensation equipment for the drillstring and riser, enabling floaters to operate in the harshest environments. Our equipment is designed and fabricated to the highest quality standards to offer years of accurate and reliable operation. We have incorporated many novel ideas to achieve easier operation and reduce maintenance than competing products.

Top mounted compensator

- Top-mounting installation reduces weight on bit (WOB) fluctuations
- Cylinder placement designed to allow standard top drives to be lifted between compensation cylinders
- Low weight of compensator module is due to vertical forces
- Compensator can be locked in any position
- High static force rating
- Unit ready for easy installation on top of the derrick at delivery
- Active-heave compensator can be easily added
- Low-friction seals are used in the cylinders and accumulator
- Geometry of the rocker arms in combination with how the wire is reeved over the guide sheaves reduces the effect of compression/decompression of the air volume due to cylinder movements
- Flow shut-off valve protects the system against uncontrolled movement if a drillstring failure occurs
- Position measuring system for the crown block
- Only hard piping between the main components (i.e., no flexible hoses)
- Customized PLC software provides simple and natural operator controls from a single point



Model	Dynamic capacity [†] , kip [tonne]	Stroke, ft [m]	Static capacity, kip [tonne]	Sheave diameter, in [mm]	Wire diameter, in [mm]	Maximum speed, mph [m/sec]	Dry weight (approximate) ^{††} , lb [tonne]
TMC 1000-25-2000	1,000.00 [453.59]	25.00 [7.62]	2,000.00 [907.18]	60.00 [1,524.00] 72.00 [1,828.80]	1.75 [44.45] 2.00 [50.80]	2.93 [1.31]	396,000.00 [179.62]
TMC 1000-25-2650	1,000.00 [453.59]	25.00 [7.62]	2,650.00 [1,202.02]	60.00 [1,524.00] 72.00 [1,828.80]	1.75 [44.45] 2.00 [50.80]	2.93 [1.31]	396,000.00 [179.62]
TMC 1500-25-2000	1,500.00 [680.39]	25.00 [7.62]	2,000.00 [907.18]	72.00 [1,828.80] 78.00 [1,981.20]	2.00 [50.80] 2.13 [53.98]	2.93 [1.31]	440,000.00 [199.58]
TMC 1500-25-2650	1,500.00 [680.39]	25.00 [7.62]	2,650.00 [1,202.02]	72.00 [1,828.80] 78.00 [1,981.20]	2.00 [50.80] 2.13 [53.98]	2.93 [1.31]	440,000.00 [199.58]

[†] Capacity at top drive elevator

^{††} Including steel APVs



Active-heave compensator

- Compact
- Lightweight
- Easy to lift/handle, access, and maintain
- Independent modules for easy disconnection
- Simple operation and full integration with top-mounted compensator (TMC)
- Operational media: mineral oil

Capacity (push/pull)	Stroke	Maximum speed	Dry weight (approximate)
61.80 kip (28.00 tonne)	25.00 ft (7.62 m)	2.93 mph (1.31 m/sec)	9,920.00 lb (4.50 tonne)

Guideline and podline tensioners

- Reliable and low-maintenance design
- Automatic flow shut-off function included in case of wire rope failure
- Easy maintenance at defined locations

	16 kip Imperial (US)	SI
Tensioner capacity	16.09 kip	7.30 tonne
Wire line travel	50.00 ft	15.24 m
Maximum line speed	354.33 ft/min	1.80 m/sec
Tensioner cylinder stroke	12.50 ft	3.81 m
Wire sheave diameter	27.95 in	711.20 mm
Wire rope diameter	0.75 in	19.00 mm
Hydraulic fluid type	—	Water glycol based
Maximum fluid pressure	3,002.28 psi	207.00 bar
Maximum pressure in working air pressure vessels	3,002.28 psi	207.00 bar



Wireline riser tensioners

Cameron wireline riser tensioners are designed to maintain the riser string in tension on floating vessels.

Three versions currently are available. The 160-, 200-, or 250-kip double-wire rope tensioners include idler sheaves, wire, rotating deadline drum, valve block skids, APVs, control system, anti-recoil, and optional air compressors.

- Compact and robust mechanical design
- Easy maintenance at defined points
- Hydraulically driven deadline drum simplifies wire replacement
- Manifold valve blocks used to reduce the amount of piping and number of leakage points
- State-of-the-art anti-recoil valve with flow shut-off function allows for safe normal operation and disconnect operation
- State-of-the-art tensioner cylinder rod coating for harsh marine environment
- High degree of redundancy in the system
- State-of-the-art redundant control system ensures an efficient, safe, and smooth operation
- Separate filling and draining unit provides easy and safe filling and draining of compensation fluid
- System operation is conducted from the drilling control room (DCR) and a local operator panel in the moonpool area

	160 kip		200 kip		250 kip	
	Imperial (US)	SI	Imperial (US)	SI	Imperial (US)	SI
Dual tensioner capacity	2.00 × 160.00 kip	2.00 × 72.57 tonne	2.00 × 200.00 kip	2.00 × 90.72 tonne	2.00 × 250.00 kip	2.00 × 113.40 tonne
Single tensioner capacity	160.00 kip	72.57 tonne	200.00 kip	90.72 tonne	250.00 kip	113.40 tonne
Wire line travel	50.00 ft	15.24 m	50.00 ft	15.24 m	50.00 ft	15.24 m
Maximum line speed	330.71 ft/min	1.68 m/sec	330.71 ft/min	1.68 m/sec	330.71 ft/min	1.68 m/sec
Tensioner cylinder stroke	12.50 ft	3.81 m	12.50 ft	3.81 m	12.50 ft	3.81 m
Wire sheave diameter	64.00 in	1.63 m	78.00 in	1.98 m	90.00 in	2.29 m
Wire rope diameter	2.13 in	54.10 mm	2.50 in	63.50 mm	2.75 in	69.85 mm
Hydraulic fluid type	—	Water glycol based	—	—	—	—
Maximum fluid pressure	3,000.00 psi	206.84 bar	—	—	—	—
Maximum pressure in working air pressure vessels	3,000.00 psi	206.84 bar	—	—	—	—
Maximum pressure in standby air pressure vessels	4,350.00 psi	299.92 bar	—	—	—	—

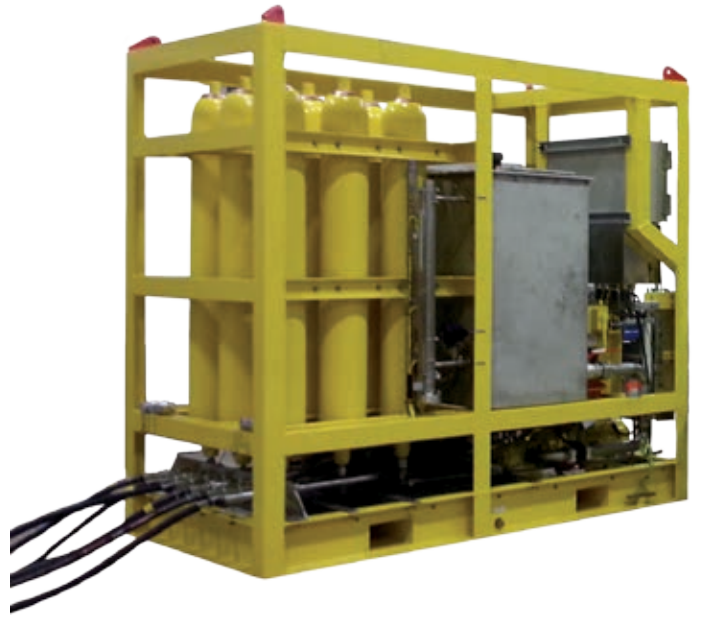

Conductor tensioner systems

- Maintain the conductor system in tension to prevent buckling under compressive load from the BOP or self-weight
- Simple adjustment of tension load
- Redundancy if one cylinder fails
- Easy manual adjustable lateral supports
- Compact and reliable design
- Splittable CTU design is standard
- Remote monitoring of the cylinder tension force from the Drilling Control Room (DCR)
- Available for operation with water/glycol based fluid
- Suitable for hazardous area operation

Model	Tension load capacity, kip [tonne]	Horizontal load capacity, kip [tonne]	Conductor size range, in [mm]	Number of cylinders	Cylinder stroke, in [mm]	Maximum operating pressure, psi [bar]
CTU 272	600.00 [272.16]	77.00 [34.93]	9.63–36.00 [244.60–914.40]	4	13.80 [350.52]	3,000.00 [206.84]
CTU 400	882.00 [400.07]	77.00 [34.93]	9.63–36.00 [244.60–914.40]	4	13.80 [350.52]	3,000.00 [206.84]
CTU 500	1,100.00 [498.95]	265.00 [120.20]	9.63–36.00 [244.60–914.40]	4	39.40 [1,000.76]	3,000.00 [206.84]

Drilling Derricks

Cameron delivers a variety of drilling derricks, purpose-built to meet our customers' preferences with respect to loading and operational conditions. We design and fabricate to comply with all industry standards using the latest 3D design tools, focusing on low weight and life cycle cost, easy fabrication, quick quayside erection and complete interfaces with drilling and third-party equipment. Derrick structures are available in various configurations for fixed or floating platforms, to handle triples and quads, and ratings up to 1,250 ton (1,133.98 tonne) at the top drive stem, and are supplied to a number of vessel specifications. API monogramming is also available.

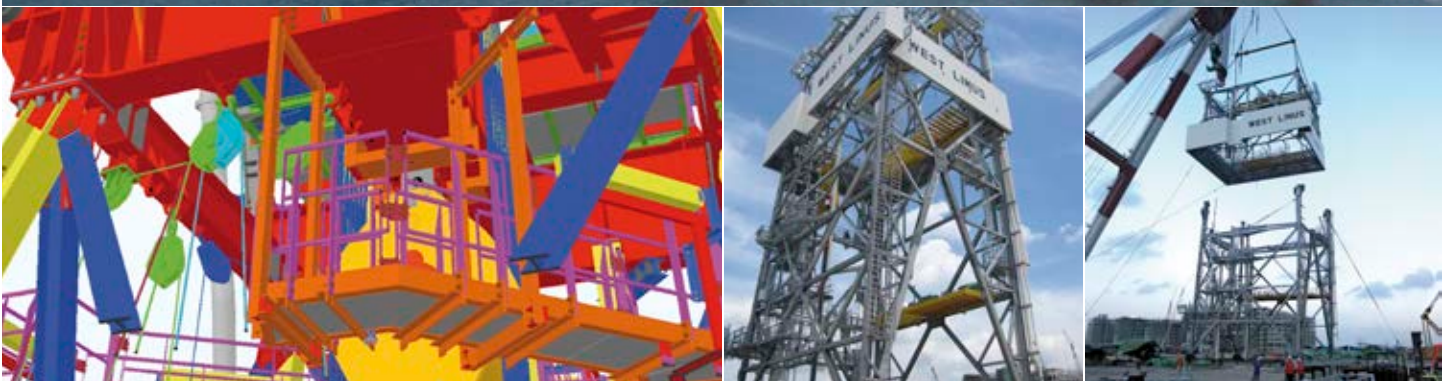

- Designed and fabricated according to the latest edition of API 4F model specifications
- ABS/DNV certified
- Area of operation according to customer's requirement(s), generally API Bull 2INT-MET (Gulf of Mexico)
- Weight-efficient structural design
- Designed for safe operation, in compliance with North Sea safety requirement as a standard
- Designed for timely assembly on erection site
- Small quantity of loose parts, assembly in smaller sections
- 3D design for optimal layout, interface control and clash prevention
- Corrosion resistant hot-dip galvanized structure
- Generally designed for single lift onboard

Well Intervention Packages

Cameron combines an extensive knowledge in drilling, subsea handling and active-heave compensation equipment to deliver efficient Well Intervention Systems. Together with our clients we develop well intervention packages that can be optimized for special tasks, or designed as multi-purpose solutions making the vessels attractive in many segments of the market.

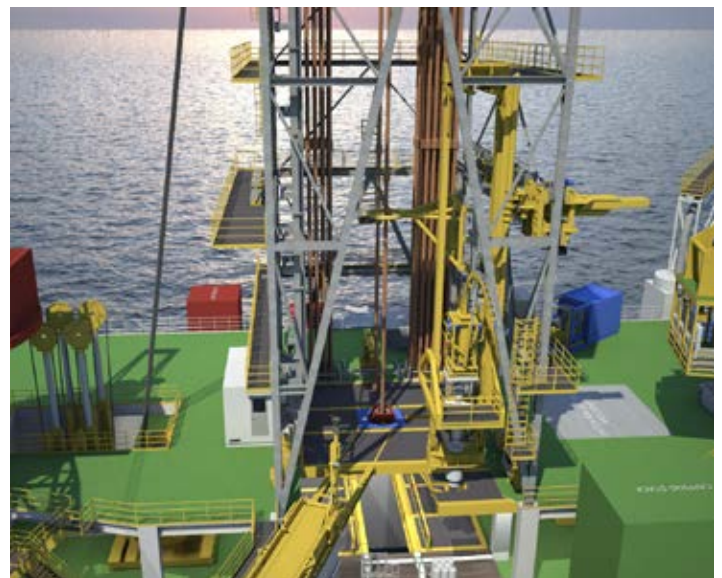
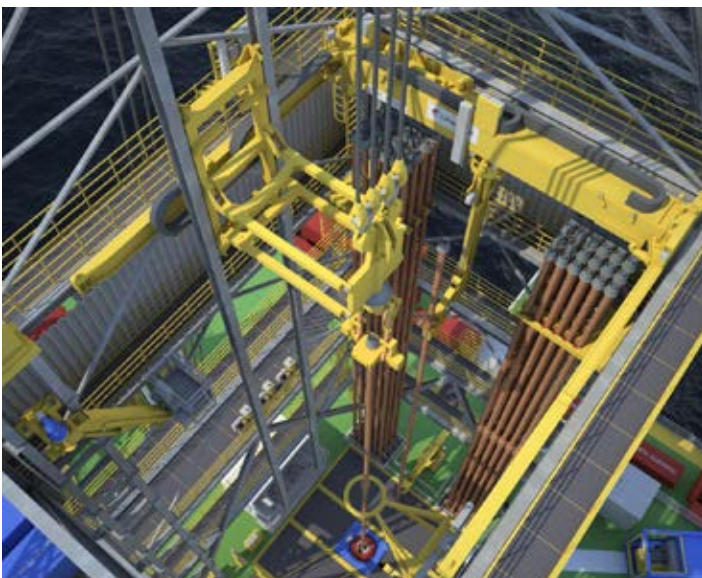

TOTAL DRILLING FLUID SOLUTIONS



Cameron offers a comprehensive range of complete drilling fluid packages and standalone equipment. Our products are designed to streamline many essential, yet time-consuming operation and maintenance procedures, improve operator safety and productivity, and reduce costly system downtime.

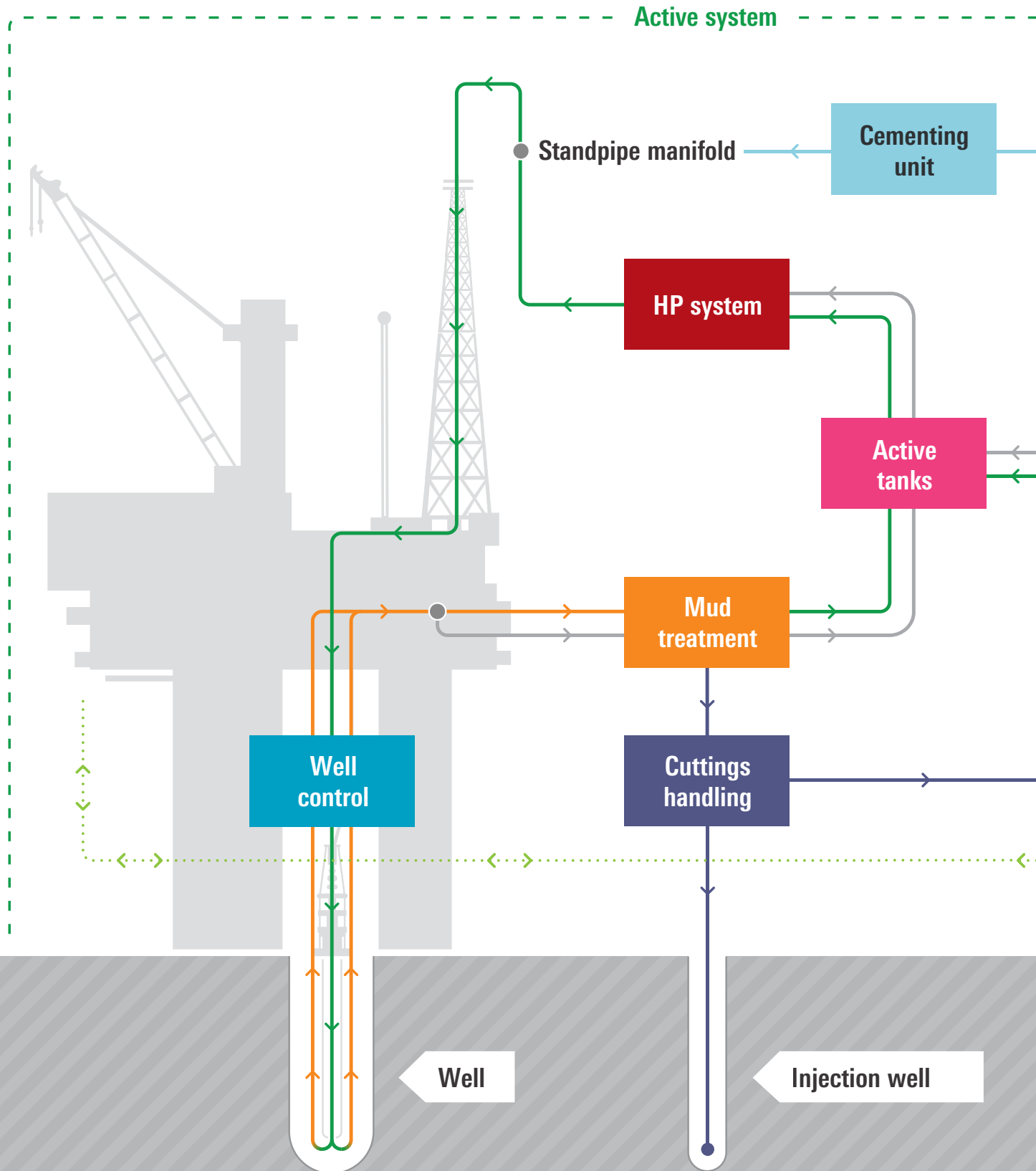

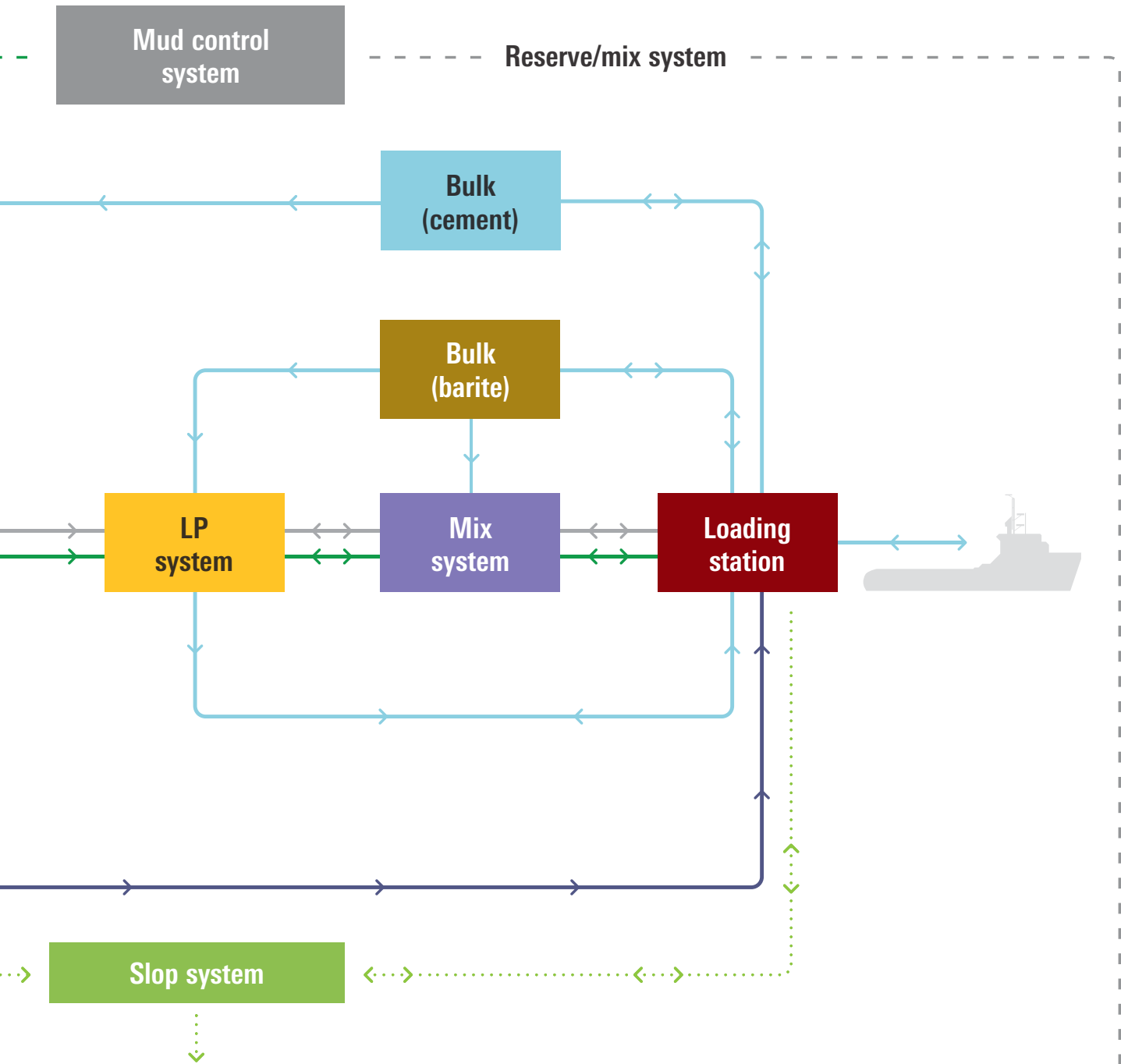

	From well (mud)		Cuttings
	Mud system 1		Slops
	Mud system 2		Bulk system

Mud Control System

The Cameron mud control system is a custom-designed control system for drilling fluids systems and processes. Offering increased product automation and system integration, the mud control system provides operators with more information and advanced control capabilities, making their jobs safer and more effective. Its purpose-designed software also enables closer monitoring and better reporting abilities that can reduce equipment downtime and improve system/production planning. Our mud control system hardware and software is engineered to ensure a flexible control system that can be upgraded as operational needs change.

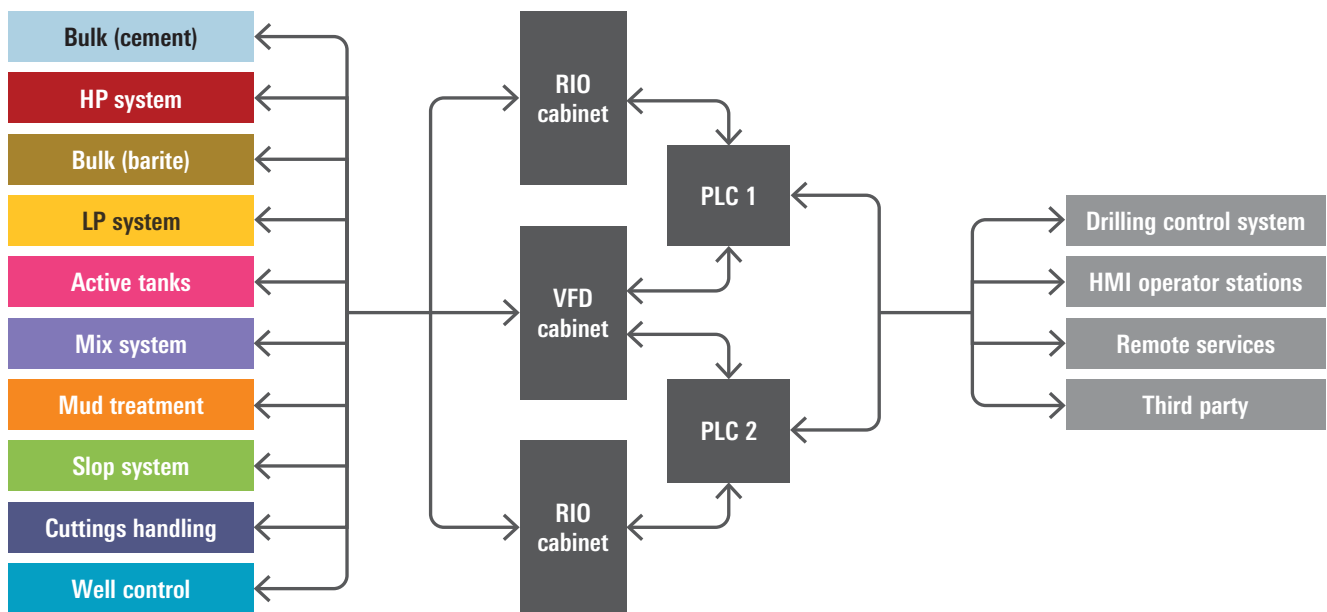

Real-time monitoring and logical control of drilling fluids equipment and complete systems from local and remote locations.



User interface and control panel engineered for optimal overview and ergonomic safety.

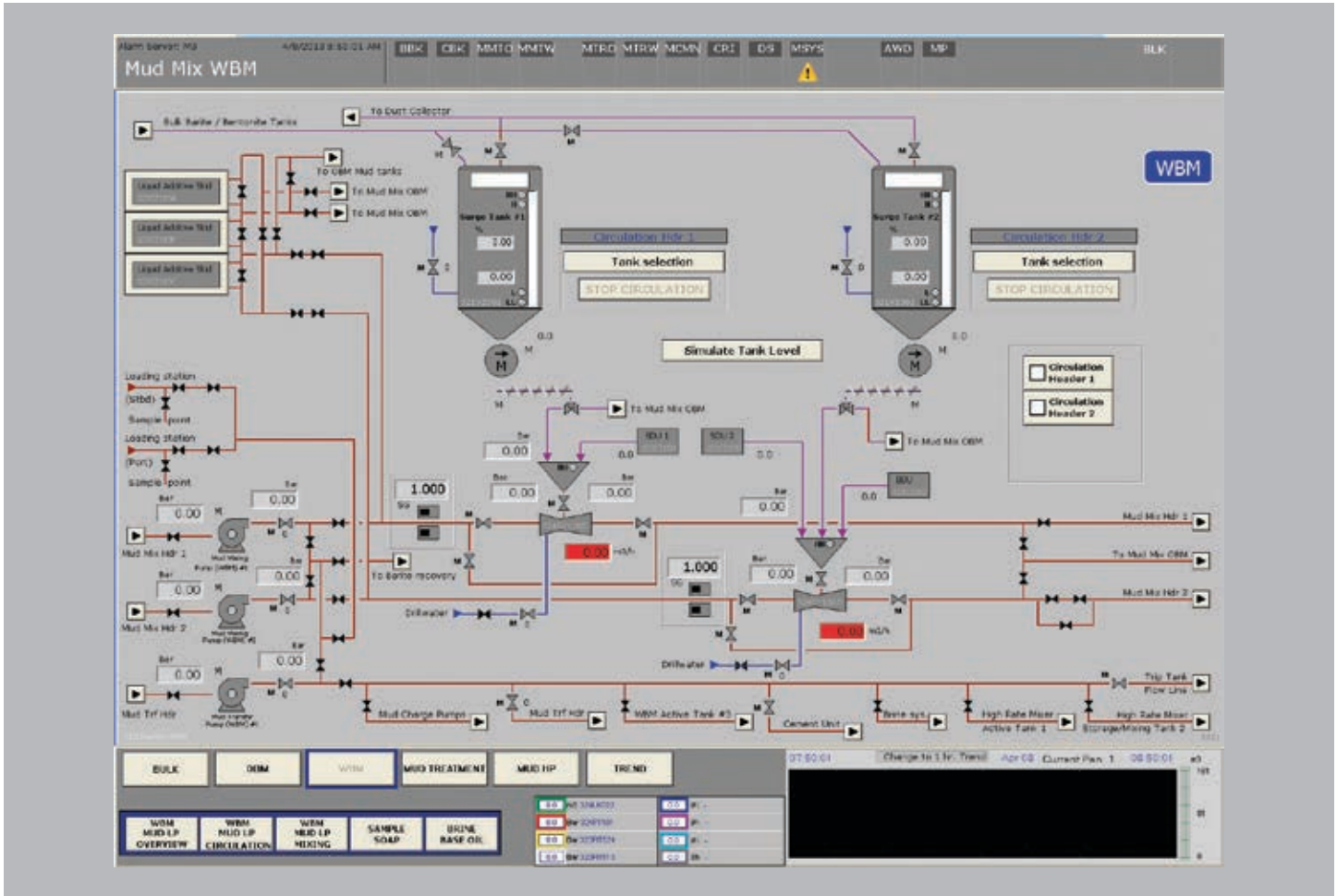

Complete control cabins

- Tailored to installation area layout
- Integrated control system equipment for handsoff mixing, dosing, and transfer operations
- Noise- and vibration-insulated housing
- Complete with windows, lights, and HVAC



Field instrumentation

- A range of field instrumentation packages are available to enhance and support the control experience
- Level indicators, pressure transmitters, density transmitters with precise degree of measurement/indication

Mud Mixing System

Cameron mud mixing and additive equipment makes drilling fluid mixing operations smarter, safer and more accurate. With our proven technology, hands-on experience and innovative thinking, Cameron has engineered a product portfolio that improves drilling fluid system operations from both production and operator standpoints. Whether you need a full system design or standalone equipment, Cameron has mud mixing and additive solutions that help improve your operations.

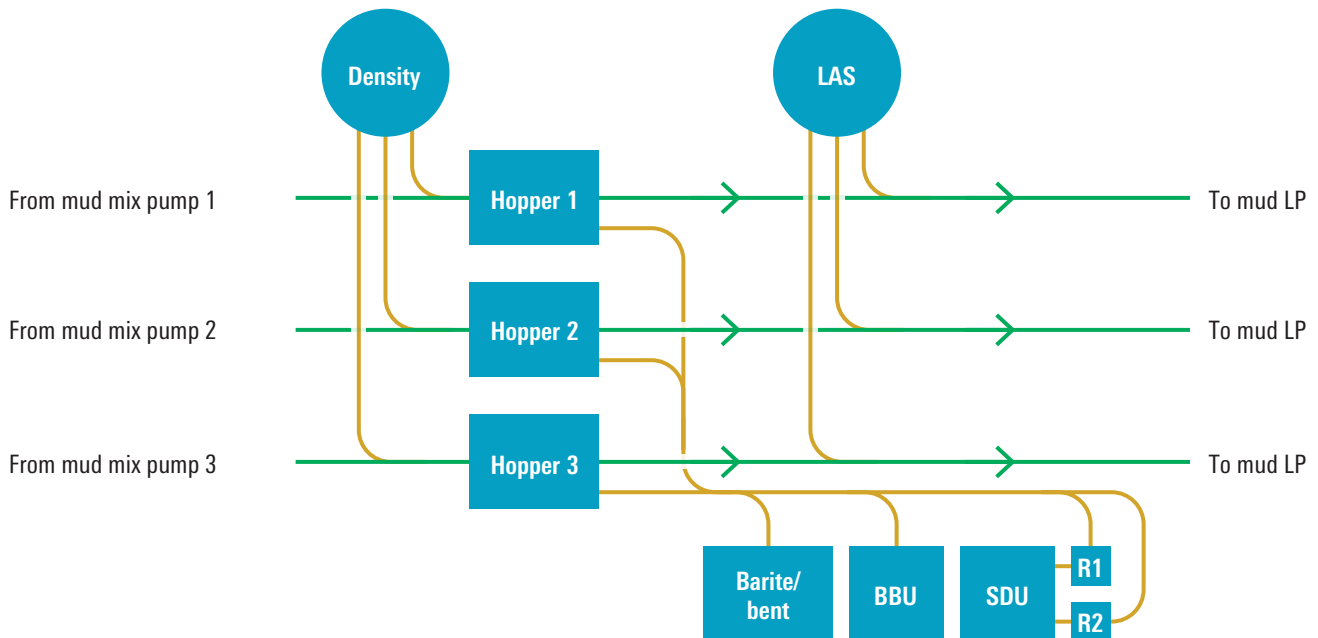



Sack dosing unit (SDU)

- Standalone unit with integrated control system
- Market's most compact footprint
- Dust-free in operation
- Integrated waste compactor
- Can be assembled on a skid for easy installation
- Accompanied with a vacuum lifter and electro-hydraulic lifting table

SHR sack-handling robot technology

- Customized and highly flexible layout
- Scalable system for multiple pallets/chemicals
- Depalletizing robot
- Intelligent vision system
- Minimized exposure to chemicals for operators
- Reduced manual handling
- Increased automation



Big bag unit (BBU)

- Cuts and doses big bags up to 1 ton (0.91 tonne)
- Removable discharge hopper designed to prevent wastage and material clogging
- Integrated dust filter and vibration unit
- Automatic dosing screw conveyor to hopper
- Weight control system

Liquid additive skid (LAS)

- Easy and accurate/reliable dosing of liquid chemicals
- Compact footprint
- VFD-controlled hose pumps
- Easy cleaning and maintenance
- Integrated control system with local control panel for real-time monitoring and control

Mixing hopper

- Skid-mounted for ease of installation
- Venturi-type mud mixer
- Low-maintenance requirements
- Suitable for powder and liquid mixing
- Direct discharge into mixing lines

Bulk Storage And Transfer System

The Cameron bulk storage and transfer system is a complete solution for bulk barite, bentonite, and cement storage. Each system is custom-engineered to meet your production requirements and offers efficiency enhancing options such as full instrumentation packages, remote valves, product automation, and remote system control capabilities.

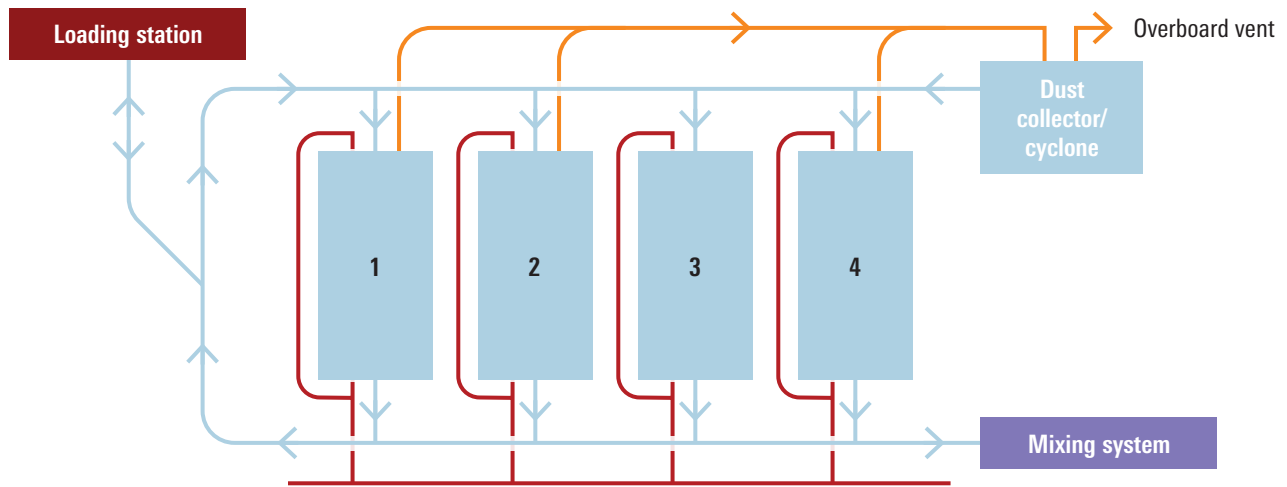

Bulk mud/cement storage and surge tanks

- Tank design minimizes potential wastage, clogging, and maintenance downtime
- Three-legged or skirt-support design provides superior stability
- Aeration panels in cone and base ensure optimal flow during pressurization and discharge processes and minimize the amount of material left in the tank after emptying
- Full instrumentation package
- Remote, real-time monitoring, and control capabilities for repetitive tasks
- Meets ASME standards
- ABS/DNV certification



Dust cyclone and collector unit

- Reclaims and recycles costly powder dust into the bulk storage system
- Automatic filling, separation, and discharge
- Proven effective operation in any climate condition
- Single cyclone-type separator delivers ongoing high operational efficiency



Loading stations

- Self-supporting frame with internal piping, couplings, and lifting legs
- Hydraulic-driven reels
- Loading hoses
- Portable remote control



Cement discharge valve

- Optimizes the fluidization process within the silo tank
- Provides high levels of precision, easier control, and better results during bulk cement transfer
- Low maintenance
- Electrically-actuated control valve



Cell feeder

- Enables automatic dosing of bulk material from surge tank into mixing hoppers
- Improves dosing accuracy
- VFD-controlled

Mud Treatment System

Together with M-I SWACO, a Schlumberger company, we are able to provide our customers with custom-engineered and industry-proven cuttings, solids, and treatment equipment. M-I SWACO is one of the world's leading manufacturers and suppliers of mud treatment systems.

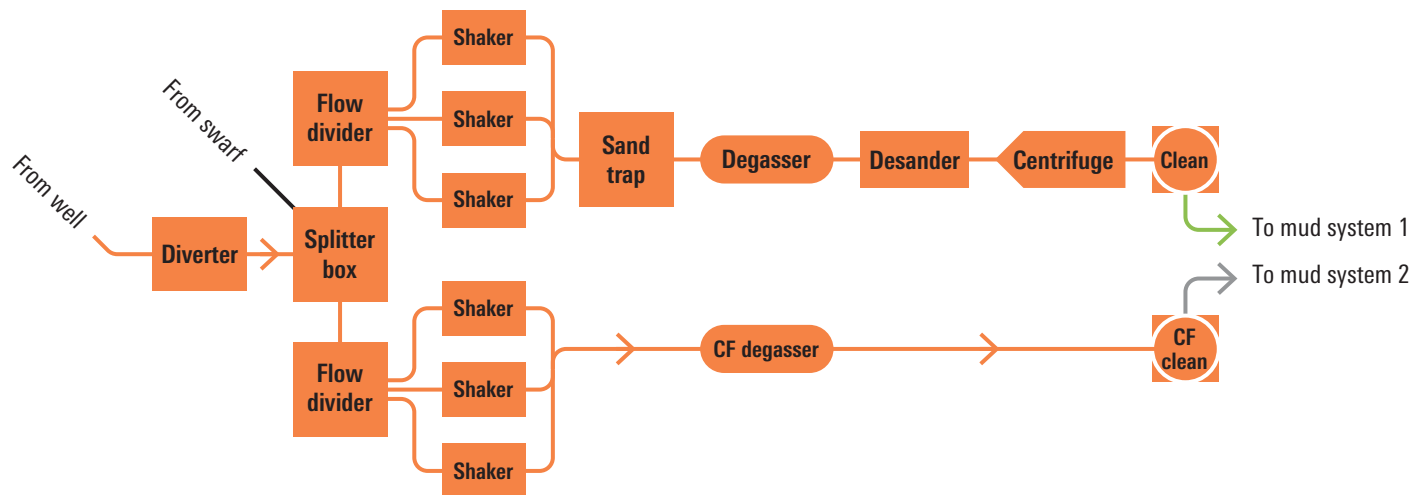

Shale shakers

- Single/dual/triple deck
- Single/dual motion
- Small footprint
- Modular platform
- Deck adjustment
- Maximized fluid distribution on screen area
- Ventilation hood with front hood available



Degasser

- Centrifugal and vacuum degassers
- Small footprint and compact design
- High-capacity and high-efficiency
- Robust design with minimal maintenance
- Remote operation available

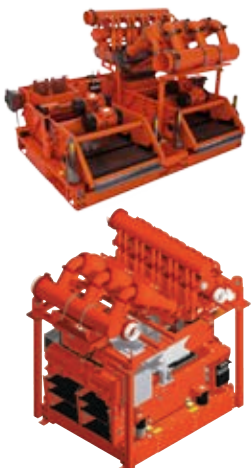

Mud cleaners

- Field-proven cone design
- 12 in (304.8 mm) desander cones, 4 in (101.6 mm) desilter cones
- High-processing rate
- Slant-mount or vertical-mount
- Ventilation hoods available
- Replaceable, wear-resistant, polyurethane hydrocyclones come with quick-release clamps



High-pressure shear unit

- Effective shearing of drilling fluid
- Pressure up to 10,000 psi
- Easy installation
- Straight or angle top connection

Low-Pressure System

Cameron engineers works with you to assess, calculate and design your low-pressure mud system or equipment. We work with some of the world's leading suppliers of LP equipment to offer low-pressure pump packages and agitating units to suit every operation.

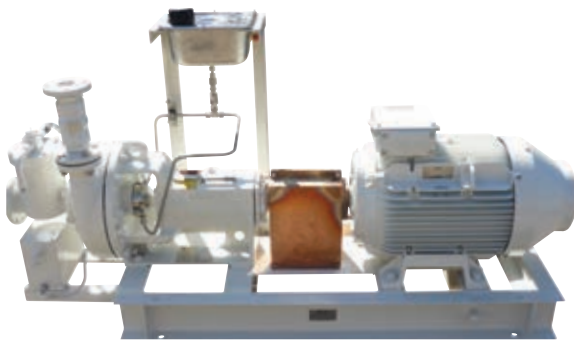
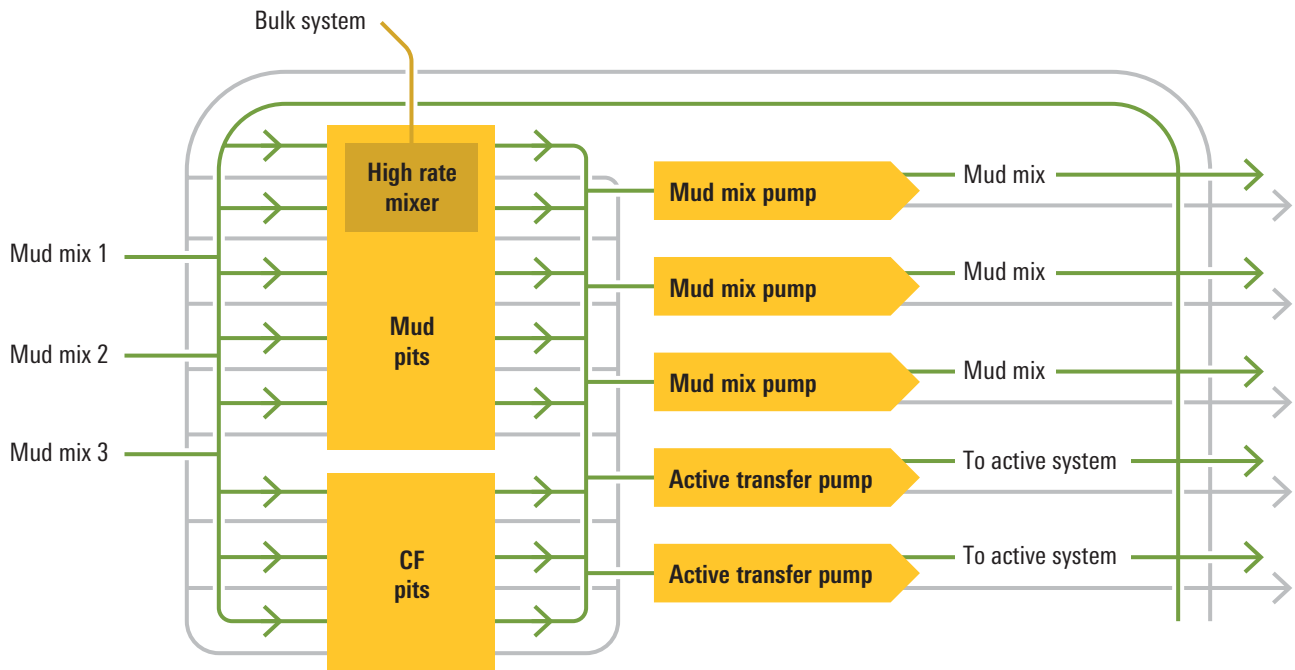

Low-pressure pumps

- DNV type certified
- Semi-open special impellers
- High-quality bearings and mechanical seals
- Concentric casing design with heavier frames

Agitating equipment

- Shaft type or submersible high-performance agitators
- Durable design
- Minimal energy consumption
- Minimal maintenance
- Space-saving and easy installation
- Functions according to ATEX and CE directive

Tank washing equipment

- Streamlines process of mud pit cleaning and reduces personnel exposure to hazardous chemicals
- Designed for robust and reliable operation
- Constructed from highly corrosion-resistant materials
- Custom-engineered

High-Pressure System

Cameron offers a range of integrated pump packages, including top- or rear-mount AC- or DC- electric drives, controls, manifolds, piping, and accessories for onshore and offshore applications. All equipment is designed and manufactured in accordance with specific project requirements, with local and remote control available.

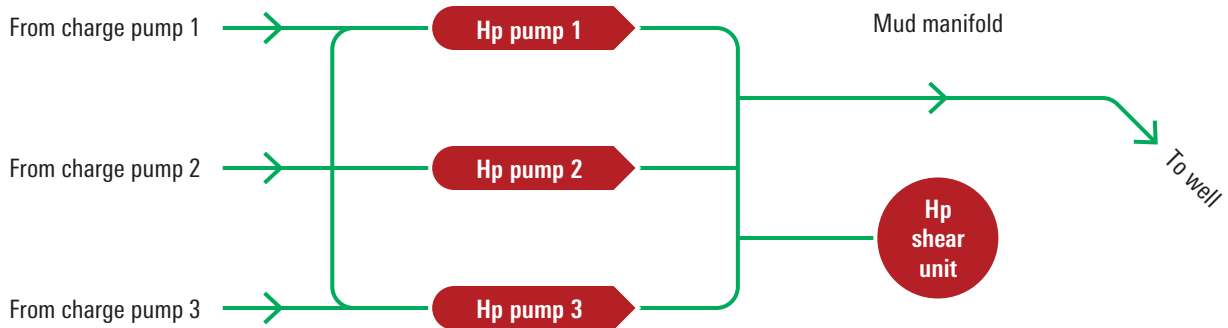

High pressure pumps

- 1,300 to 2,200 hp (969.41 to 1,640.54 kW)
- High-discharge flow rates
- Impressive power-to-weight ratios
- One-piece, forged and fabricated alloy-steel crankshaft for smooth operation and enhanced longevity
- High-performance steel connecting rods
- Forged alloy-steel pinions and gears
- Triple-redundant power-end lubrication
- Installed on a heavy-duty oilfield skid for added strength and durability

Model	Maximum input horsepower (kW rating) ¹ , hp [kW]	Stroke, in [mm]	Maximum pump speed, Spm	Maximum liner size, in [mm]	Maximum flowrate, gal/min [L/min]	Maximum discharge pressure ³ , psi [kg/cm ²]
WH-1312	1,300.00 [969.41]	12.00 [304.80]	130	6.75 [171.45]	725.00 [2,744.42]	5,000.00 [351.55]
WH-1612	1,600.00 [1,193.12]	12.00 [304.80]	120	7.50 [190.50] ⁴	826.00 [3,126.75]	7,500.00 [527.32]
W-1712	1,700.00 [1,267.69]	12.00 [304.80]	120	7.50 [190.50] ⁴	826.00 [3,126.75]	7,500.00 [527.32]
W-2214	2,200.00 [1,640.54]	14.00 [355.60]	110	9.00 [228.60] ⁵	1,272.00 [4,815.04]	7,500.00 [527.32]
W-2215	2,200.00 [1,640.54]	15.00 [381.00]	110	9.00 [228.60] ⁵	1,363.00 [5,159.52]	7,500.00 [527.32]

¹ Based on 90% mechanical efficiency

² Based on 100% volumetric efficiency

³ Pressures greater than 5,000 psi require high-pressure fluid ends

⁴ Liner is induction-hardened, therefore liner life is reduced

⁵ Requires special retention system; liner is induction-hardened, therefore liner life is reduced

All specifications are subject to change. Information important to a particular application should be verified by Cameron.

Mud Modules

Cameron delivers a new generation of mud modules that are more compact, efficient, and reliable.

- Reduce, and where possible, prevent human exposure to dangerous materials
- Develop a more efficient treatment and mixing system for drilling fluids
- Improve mud logistics, pre-mix, and cuttings handling
- Employ technology and equipment that minimize the industry footprint on local and global environments
- Maximize available installation area

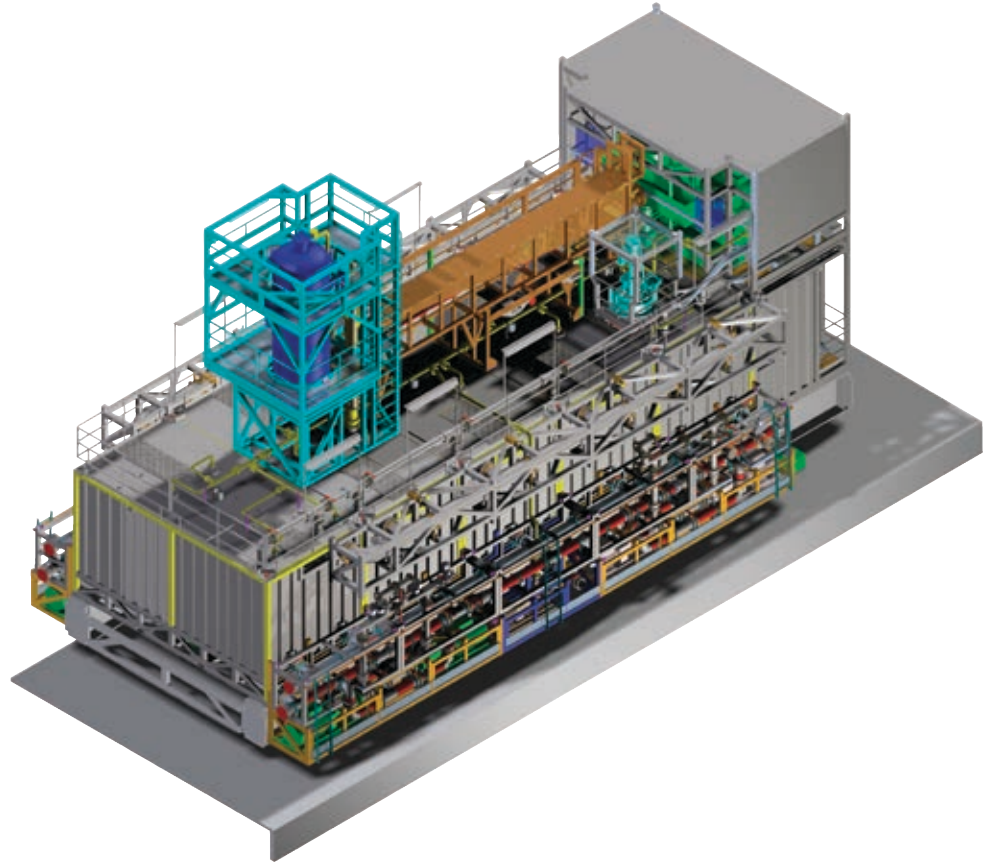

Containerized Solutions

A range of flexible containerized solutions are offered at Cameron for a variety of applications anytime and anywhere.

- Streamline and optimize transport and installation procedures
- Standalone system/plug-and-play
- Customized solutions
- Compact designs
- Factory tested

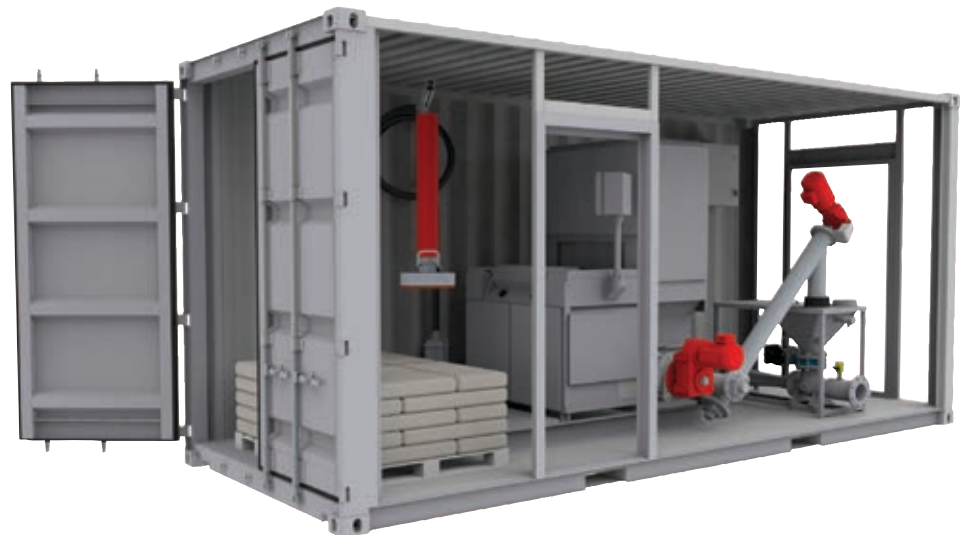

Surveys and Upgrades



Comprehensive services expertly delivered

- Offshore surveys to advise mud system upgrades
- Planning, engineering, onshore fabrication, offshore installation, and commissioning of complete system upgrades
- System documentation and training for offshore personnel
- System certifications

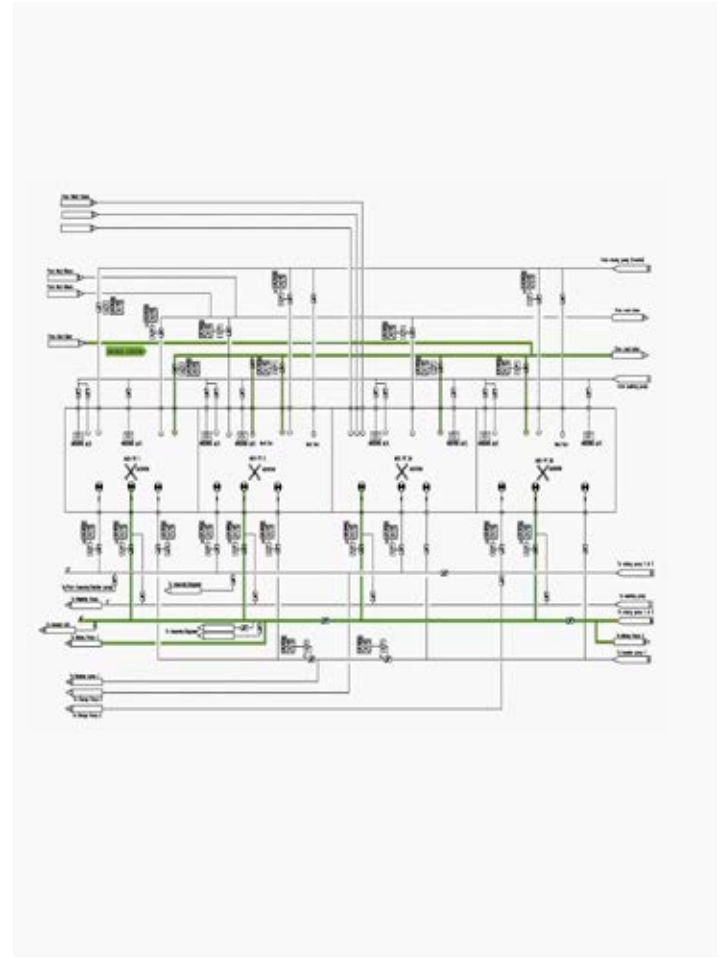

Engineering services

- Process and instrumentation diagram (P&ID) design for complete mud systems
- Flow calculations

SERVICES



With Cameron Services, you have a world of resources at your command — around the clock and around the globe. Dedicated to optimizing your operations and reducing your total cost of ownership, we have the most locations worldwide, staffed with qualified people who are accessible 24/7, so you are never without service when you need it. What's more, our integrated systems and advanced processes enable us to provide faster turnaround. And, as the OEM, we know our products better than anyone and know how to best service them.

Comprehensive services expertly delivered

As the market leader in services, we provide flexible solutions through five main areas that lower the total cost of ownership of your equipment:

- **Parts**—Immediate delivery of genuine OEM replacement parts for many Cameron products.
- **Life of field services**—Field service technicians are available around the world 24/7 to provide a wide variety of services that range from field repairs to preventive maintenance, technical support, and training.
- **Repairs**—Service centers offer a full range of equipment repair services, including disassembly, inspection, reassembly, testing, and parts replacement.
- **Remanufacturing**—Provides remanufacturing of oilfield equipment to return products to first-class, fit-for-function or working-condition performance standards.
- **Asset management**—Provides a range of asset management services, including storage/warehousing, utilization, brokering, buy-back, and exchange.





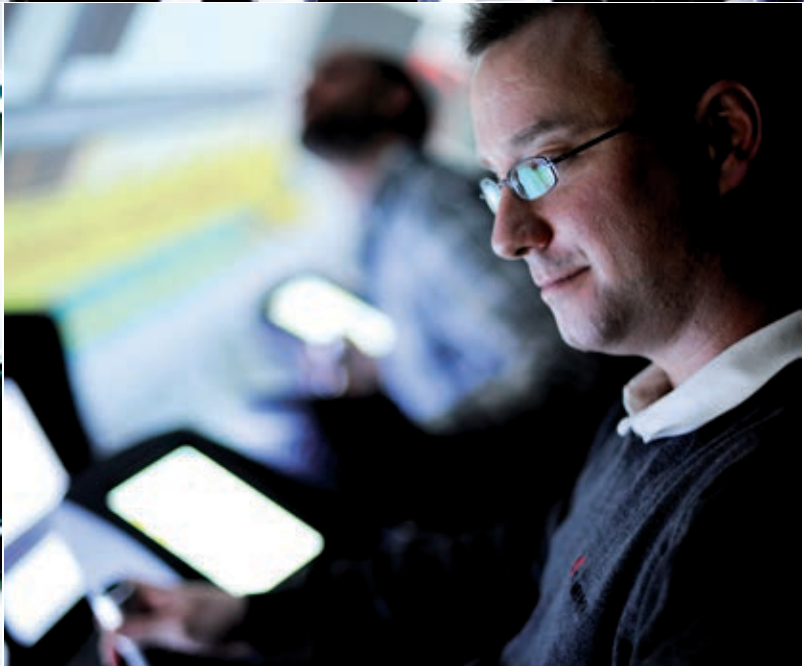
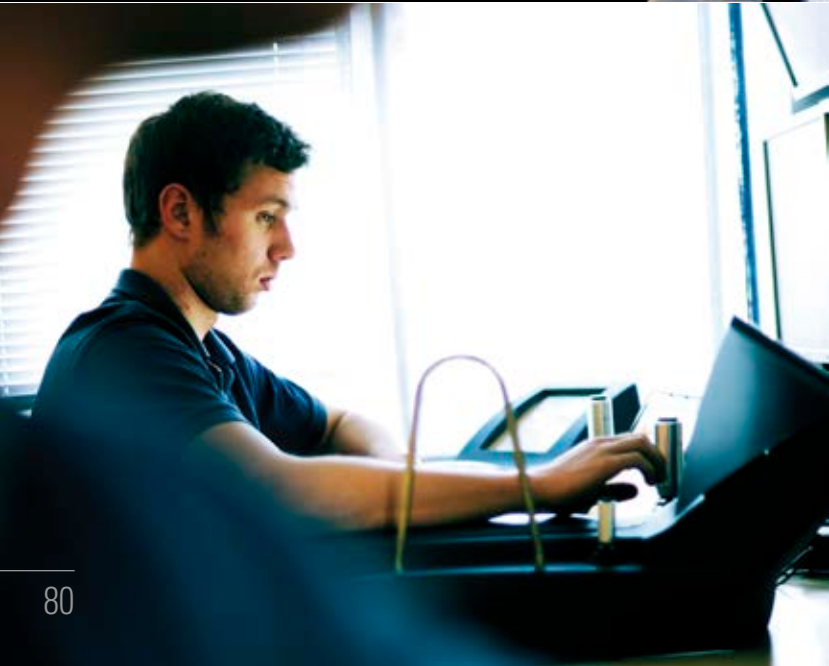

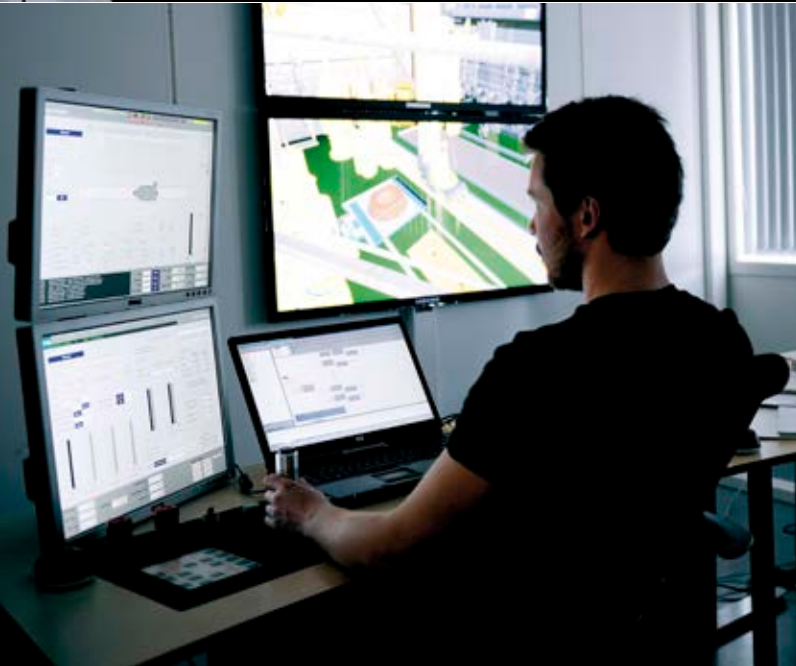
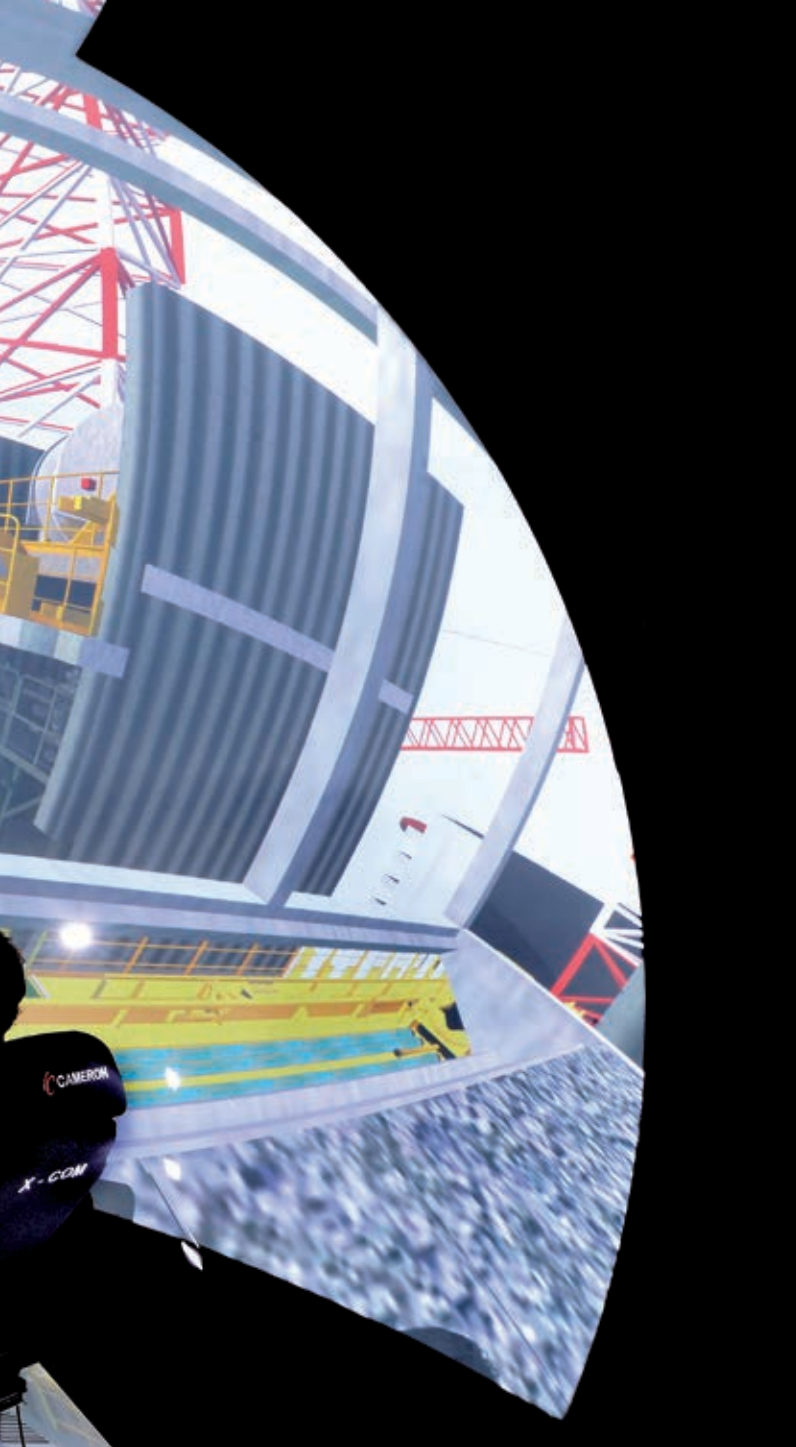

Remote access center

To help better support our customers, Cameron control systems are designed to enable remote access. A VPN router for secure authorization and a Cameron support PC are the only two components needed to enable a gateway to all of Cameron PLCs.

Rig efficiencies

The Cameron support center is able to remotely access each computer and PLC just as if our support team was on the rig or vessel themselves. Having the capability to remotely locate and correct issues in cooperation with the rig maintenance crew provides the customer with timely support and efficiencies in rig operations. Cameron software engineers are also available to provide customers with troubleshooting assistance which can reduce the need for the rig or vessel's maintenance crew to access the advanced software themselves.

Cost savings

Cameron OnTrack24 Remote Access can reduce the need for costly service interventions by allowing software issues to be resolved and software updates to be implemented remotely, without the need for Cameron field service technicians onboard the rig.

Simple upgradability

Updates to PLC software for controlling drilling equipment as well as HMI updates to the Cameron X-COM operator chair, OnTrack servers and workstations can be seamlessly implemented and tested from the Cameron remote access system.

Laboratory

Cameron software is developed in a dynamic 3D HIL test simulator environment. Furthermore, test activities normally carried out during commissioning are verified at equipment delivery. All software is developed in accordance with DNV-RP-D201.

Simulation

The Cameron drilling simulator is used to train the rig's operational and maintenance crews by providing familiarization of the machinery and control stations, sequences collaboration, manual operation and unexpected scenarios. In addition, the simulator also aids in internal training to ensure that our service personnel are continually updated with the latest features and equipment.

Utilizing 3D models, the Cameron drilling simulator is based on the equipment and machine software that is used on the rig, which reduces variability between real life and simulator operations. The operator is able to reverse, stop, or change the operation at any time. The simulator training is suitable for those participants who have previously taken Cameron operational training. The Cameron drilling simulator has the following main components:

- X-COM operator chairs
- Instruction station computer
- PLC simulator computer
- 3D model simulator computer
- 3D visualization system
- Audio system

Global Network



LEGEND

- Current locations
- ⊙ New and expanding locations

Cameron operates around the world from more than 300 locations that reach virtually all of the world's oil and gas operating basins. Our global network of sales, service, and strategically located in-house manufacturing centers means customers benefit from faster ordering times, quicker deliveries and easier access to Cameron professionals, no matter where your operations are located. Count on Cameron to be there, anywhere we are needed.



Drilling Products Overview



cameron.slb.com/drilling

Chart design: Tress Design – www.tressdesign.no – pages: 64 and 65
Photos: Allan Klo, Statoil, page: 4 | Anders Martinsen, pages: 2, 30, 42, 43, 45, 46 and 47
Anne Lise Norheim, pages: 33, 44, 77, 79, 80 and 81 | M-I SWACO, page: 72

*Mark of Schlumberger
Other company, product, and service names are the properties of their respective owners.
Copyright © 2017 Schlumberger. All rights reserved. 17-DRL-243727

