

# Code•Master™ 2 HID Factory Sealed Luminaires

Explosionproof, Dust-Ignitionproof

Hazardous Locations. For use with threaded metal conduit.

Integrally Ballasted. 50 W, 70 W, 100 W, 150 W, 250 W, 400 W HPS; 175 W, 250 W, 400 W PSMH; 175 W, 250 W, 400 W MH.

NEC: Class I, Division 1 and 2, Groups C, D | Class II, Division 1 and 2, Groups E, F, G | Class III | Marine Type Electric Fixtures Outside Type (Salt Water)

CEC: Class I, Division 1 and 2, Groups B, C, D | Class I, Zone 1 and 2; IIB, IIA | Class II, Division 1, Groups E, F, G | Class II, Division 2, Groups F, G | Class III | CSA Type 4X | Exd IIB, Zone 1

## Applications

- Ideal for use in chemical and petrochemical plants, such as manufacturers of plastics, paints and thinners; in refineries; and in other process areas where ignitable vapors, dust, moisture and corrosive elements may be present.
- Suitable for use in wet locations.

## Features

- Fixtures operate safely in high ambient temperatures. For example, in Class I areas the 150 W HPS fixture operates at a maximum temperature of +120 °C (+248 °F) in a +65 °C (+149 °F) ambient [+100 °C (+212 °F) temperature in a +40 °C (+104 °F) ambient].
- Arrangement of heat-producing components results in more efficient heat dissipation for cooler fixture operation.
- “Wireless” design. Threading of fixture unit onto mounting hood makes electrical connection. Only wiring required is attaching two wires to connection block in mounting hood.
- Connection block is easily wired: (a) loosen two screws, (b) make wire connections and (c) re-position connection block.
- Safe, easy servicing without disconnecting any wiring. “Wireless” fixture unit easily threads off mounting hood for convenient servicing or for immediate replacement with a “stand-by” unit.
- Acme double-lead threads speed installation and fixture removal from mounting hood — only half as many turns are required as for single-lead threads. The threads do not stick or gall, eliminating the troublesome problems often encountered with single lead threads during fixture unit removal.
- All threaded joints are flame-tight.
- Integrally ballasted HID lighting fixtures; separate ballasts not required.
- Factory sealed. External seals not required.
- Strategic location of lamp socket in combination with the interior prism design of the glass globe provides optimum light distribution and control.
- Superior corrosion resistance, with epoxy powder coat finish.
- Porcelain socket with nickel-plated phosphor bronze screw shell. Assures long trouble-free operation in high ambient areas.
- Choice of mountings: pendant, ceiling, bracket and stanchion.
- Fiberglass-reinforced polyester reflectors, in standard dome, deep dome or 30° angle, are ideal in installations where luminaire is subject to exceptionally severe corrosive atmospheres. The high bay aluminum reflector is indicated in installations where mounting height from work plane ranges from 20 feet/6 meters and higher.
- Optional guards protect globes from damage. Secured to fixture with three screws.
- Light sources: high pressure sodium, pulse start metal halide or metal halide. HPS is excellent where long lamp life is required. HPS provides high lumens per watt and is less expensive to operate. PSMH/MH is desirable where colors of illuminated areas must be close to natural. PSMH/MH provides better color rendition, increased lumen output, longer lamp life, and faster restrike after momentary power interruption.
- A wide range of ballasts and voltages are available for both domestic and export applications.
- Ballasts operate at low temperatures – PSMH: -29 °C (-20 °F); HPS: -40 °C (-40 °F); MH: -35 °C (-31 °F).
- 50 W through 150 W high pressure sodium ballasts are high reactance, high power factor type.

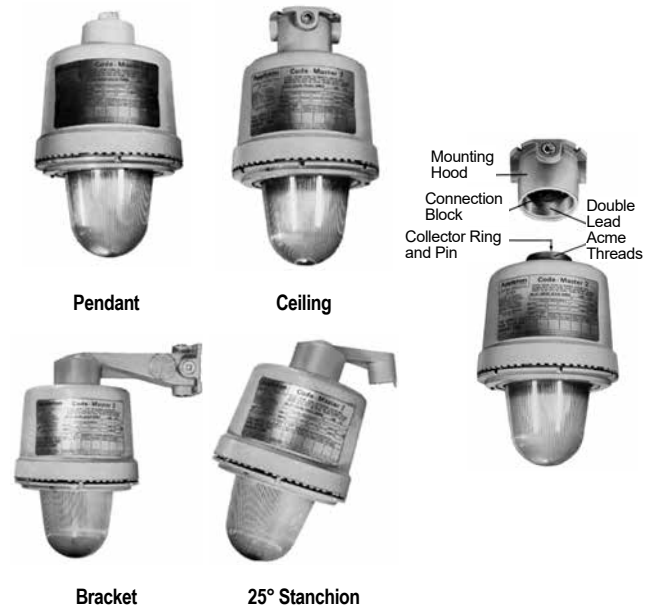

## Standard Materials

- Ballast bodies and guards: copperfree (4/10 of 1% max.) aluminum
- Pendant mounting hoods: diecast copperfree (4/10 of 1% max.) aluminum
- Ceiling, bracket and stanchion mounting hoods: sand cast copperfree (4/10 of 1% max.) aluminum
- Reflectors: aluminum or fiberglass reinforced polyester

## Standard Finishes

- Ballast bodies, guards and mounting hoods: epoxy powder coat finish, electrostatically applied for complete, uniform corrosion protection

## Options

- Fuses for field installation can be ordered by catalog number from fuse kit table.
- Quartz Auxiliary Emergency Lamp for PSMH/MH and HPS fixtures. Relay switch installed in fixture. Add suffix -E to fixture catalog number. ①

## NEC/CEC Certifications and Compliances

- UL Standard: UL 1598, UL 844
- UL Listed: E10444
- CSA Standard: C22.2 No. 250, C22.2 No. 137
- CSA Certified: 025428

① Quartz Auxiliary Emergency Lamps for PSMH/MH and HPS fixtures are for ordinary locations only.

# Code•Master™ 2 HID Factory Sealed Luminaires

Explosionproof, Dust-Ignitionproof

Hazardous Locations. For use with threaded metal conduit.

Integrally Ballasted. 50 W, 70 W, 100 W, 150 W, 250 W, 400 W HPS; 175 W, 250 W, 400 W PSMH; 175 W, 250 W, 400 W MH.

NEC: Class I, Division 1 and 2, Groups C, D | Class II, Division 1 and 2, Groups E, F, G | Class III | Marine Type Electric Fixtures Outside Type (Salt Water)

CEC: Class I, Division 1 and 2, Groups B, C, D | Class I, Zone 1 and 2; IIB, IIA | Class II, Division 1, Groups E, F, G | Class II, Division 2, Groups F, G | Class III | CSA Type 4X | Exd IIB, Zone 1

HID Luminaires | Area / Task | Explosionproof, Hazardous Location | NEC / CEC

## Order Using Catalog Numbering Guide — Mercmaster™ III 50-250 Watt Hazardous Location Luminaires

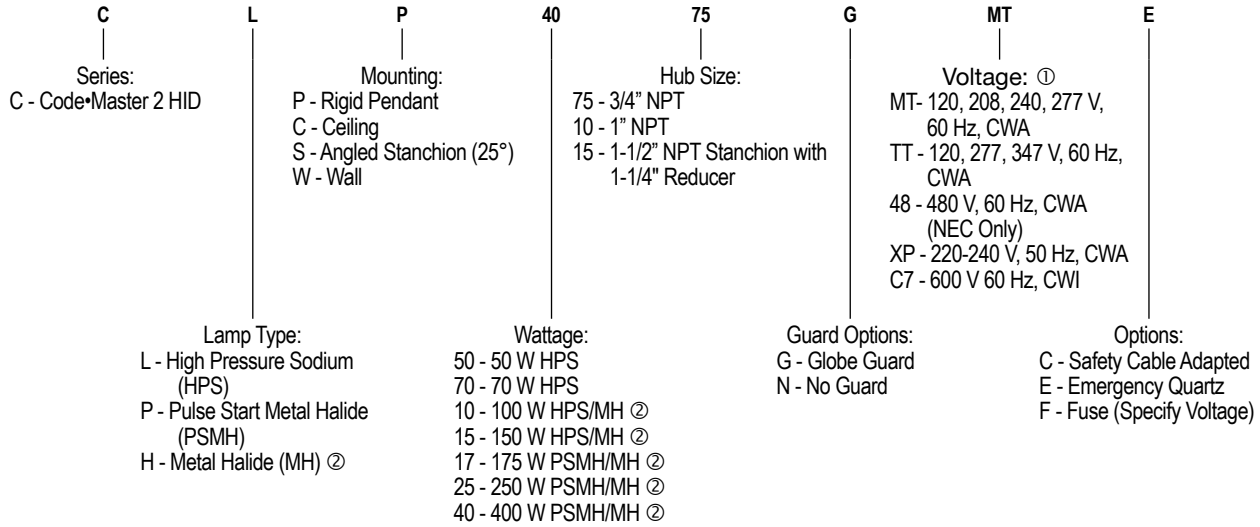

Lamp Type	Lamp Watts	Voltage Suffixes				
		MT	TT	48	XP	C7
HPS	50	X	X	X	—	—
HPS	70	X	X	X	—	—
HPS	100	X	X	X	X	—
HPS	150	X	X	X	X	X
HPS	250	X	X	X	X	X
HPS	400	X	X	X	X	X
PSMH	175	X	X	X	—	—
PSMH	250	X	X	X	—	—
PSMH	400	X	X	X	—	—
MH ②	100	X	X	—	—	—
MH ②	150	X	X	—	—	—
MH ②	175	X	X	—	X	X
MH ②	250	X	X	—	X	X
MH ②	400	X	X	—	X	X

Voltages:

**MT** - 120/208/240/277 V 60 Hz, CWA

**TT** - 120/277/347 V 60 Hz, CWA

**48** - 480 V, 60 Hz, CWA (NEC Only)

**XP** - 220-240 V, 50 Hz, CWA

**C7** - 600 V, 60 Hz, CWI

Refer to "Mounting Hoods and Ballast" page for available Voltage Configuration.

① Other voltages available. Contact your local sales representative.

② Mercury vapor and metal halide luminaires are not available for purchase within the United States. Please check with your countries governing legislation regarding allowable lamp types before ordering.

# Code•Master™ 2 HID Factory Sealed Luminaires

Explosionproof, Dust-Ignitionproof

Hazardous Locations. For use with threaded metal conduit.

Integrally Ballasted. 50 W, 70 W, 100 W, 150 W, 250 W, 400 W HPS; 175 W, 250 W, 400 W PSMH; 175 W, 250 W, 400 W MH.

NEC: Class I, Division 1 and 2, Groups C, D | Class II, Division 1 and 2, Groups E, F, G | Class III | Marine Type Electric Fixtures Outside Type (Salt Water)

CEC: Class I, Division 1 and 2, Groups B, C, D | Class I, Zone 1 and 2; IIB, IIA | Class II, Division 1, Groups E, F, G | Class II, Division 2, Groups F, G | Class III | CSA Type 4X | Exd IIB, Zone 1

## Temperature Codes | Classified Area Suitability | Suitability includes use of reflector

Lamp Watts	Lamp Type	Supply Wire Temp. °C (°F)	Ambient Temp. °C (°F)	Class I, Division 1 and 2 With Globe or with Globe and Reflector UL/NEC/CEC Temp. Ident. No.			Class II, Division 1 and 2 With Globe or with Globe and Reflector UL/NEC/CEC Temp. Ident. No. ①	
				Nameplate Marking	NEC Groups	CEC Groups	Nameplate Marking	Groups
50	HPS	60 (140)	40 (104)	T6	C,D	B, C, D	T4	E, F, G
		75 (167)	55 (131)	T5	C,D	B, C, D	—	—
		85 (185)	65 (149)	T5	C,D	B, C, D	—	—
70	HPS	60 (140)	40 (104)	T6	C,D	B, C, D	T4	E, F, G
		75 (167)	55 (131)	T5	C,D	B, C, D	—	—
		85 (185)	65 (149)	T5	C,D	B, C, D	—	—
100	HPS	60 (140)	40 (104)	T5	C,D	B, C, D	T4	E, F, G
		75 (167)	55 (131)	T5	C,D	B, C, D	—	—
		85 (185)	65 (149)	T4A	C,D	B, C, D	—	—
150	HPS	60 (140)	40 (104)	T5	C,D	B, C, D	T3A	E, F
		75 (167)	55 (131)	T4A	C,D	B, C, D	T3	—
250	HPS	75 (167)	40 (104)	T3C	C,D	B, C, D	—	—
		75 (167)	55 (131)	T3C	C,D	B, C, D	—	—
400	HPS	85 (185)	40 (104)	T3C	C,D	B, C, D	—	—
175	PSMH	75 (167)	40 (104)	T4	C,D	B, C, D	T3C	E, F, G
250	PSMH	75 (167)	40 (104)	T4	C,D	B, C, D	T3A	E, F
400	PSMH	75 (167)	40 (104)	T3C	C,D	B, C, D	—	—
175	MH ②	75 (167)	40 (104)	T4	—	B, C, D	T3C	E, F, G
250	MH ②	75 (167)	40 (104)	T4	—	B, C, D	T3A	E, F
400	MH ②	75 (167)	40 (104)	T3C	—	B, C, D	—	—

“T” Numbers Represent the Maximum Lamp Temperature for Class I, Division 2 Locations and Maximum Surface Temperature Under Dust Blanket for Class II, Division 1 Locations.

“T” #	T1	350	325	T2	T2A	T2B	T2C	T2D	T3	T3A	T3B	T3C	T4	T4A	T5	T6
Temp. Range °C (°F)	+351 to +450 (+664 to +842)	+326 to +350 (+619 to +662)	+301 to +325 (+574 to +617)	+281 to +300 (+538 to +572)	+261 to +280 (+502 to +536)	+231 to +260 (+448 to +500)	+216 to +230 (+421 to +446)	+201 to +215 (+394 to +419)	+181 to +200 (+358 to +392)	+166 to +180 (+331 to +356)	+161 to +165 (+322 to +329)	+136 to +160 (+277 to +320)	+121 to +135 (+250 to +275)	+101 to +120 (+214 to +248)	+86 to +100 (+187 to +212)	+85 (+185)

NOTE: The maximum operating temperature of the fixture must not exceed the ignition temperature of the gas, vapor or dust to be encountered per the National Electrical Code and the Canadian Electrical Code.

① Applies to Code•Master 2 only.

② Mercury vapor and metal halide luminaires are not available for purchase within the United States. Please check with your countries governing legislation regarding allowable lamp types before ordering.

# Code•Master™ 2 HID Factory Sealed Luminaires

Explosionproof, Dust-Ignitionproof

Hazardous Locations. For use with threaded metal conduit.

Integrally Ballasted. 50 W, 70 W, 100 W, 150 W, 250 W, 400 W HPS; 175 W, 250 W, 400 W PSMH; 175 W, 250 W, 400 W MH.

NEC: Class I, Division 1 and 2, Groups C, D | Class II, Division 1 and 2, Groups E, F, G | Class III | Marine Type Electric Fixtures Outside Type (Salt Water)

CEC: Class I, Division 1 and 2, Groups B, C, D | Class I, Zone 1 and 2; IIB, IIA | Class II, Division 1, Groups E, F, G | Class II, Division 2, Groups F, G | Class III | CSA Type 4X | Exd IIB, Zone 1

HID Luminaires | Area / Task | Explosionproof, Hazardous Location | NEC / CEC

Lamp Watts	Ballast Amps								Fuse Kit Catalog Number		
	Volts	High Pressure Sodium ①		Pulse Start Metal Halide Super CWA		Metal Halide CWA		Fuse Quantity Required	HPS	PSMH	MH ②
		Start	Operating	Start	Operating	Start	Operating				
50	120	0.58	0.58	—	—	—	—	1	CF-5	—	—
	208	0.35	0.33	—	—	—	—	2	CF-3	—	—
	240	0.31	0.29	—	—	—	—	2	CF-3	—	—
	277	0.25	0.25	—	—	—	—	1	CF-2	—	—
	347	—	—	—	—	—	—	—	—	—	—
	480	—	—	—	—	—	—	—	—	—	—
70	120	0.90	0.82	—	—	—	—	1	CF-5	—	—
	208	0.50	0.48	—	—	—	—	2	CF-3	—	—
	240	0.44	0.44	—	—	—	—	2	CF-3	—	—
	277	0.35	0.36	—	—	—	—	1	CF-2	—	—
	347	0.30	0.30	—	—	—	—	1	CF-2	—	—
	480	0.21	0.21	—	—	—	—	2	CF-2	—	—
100	120	1.30	1.15	—	—	1.20	1.15	1	CF-8	—	CF-6
	208	0.76	0.67	—	—	0.70	0.70	2	CF-5	—	CF-4
	240	0.66	0.58	—	—	0.61	0.58	2	CF-5	—	CF-3
	277	0.60	0.50	—	—	0.55	0.50	1	CF-3	—	CF-3
	347	0.45	0.39	—	—	0.40	0.40	1	CF-3	—	CF-2
	480	0.33	0.29	—	—	—	—	2	CF-3	—	—
150	120	2.00	1.66	—	—	1.75	1.60	1	CF-10	—	CF-6
	208	1.16	0.96	—	—	1.30	1.00	2	CF-5	—	CF-4
	240	1.00	0.83	—	—	0.85	0.80	2	CF-5	—	CF-3
	277	0.88	0.75	—	—	0.77	0.70	1	CF-5	—	CF-3
	347	0.52	0.56	—	—	—	—	1	CF-5	—	—
	480	0.50	0.44	—	—	—	—	2	CF-3	—	—
175	120	—	—	0.80	1.80	1.30	1.80	1	—	CF-5	CF-5
	208	—	—	0.50	1.00	0.75	1.10	2	—	CF-3	CF-3
	240	—	—	0.40	0.90	0.65	0.90	2	—	CF-3	CF-3
	277	—	—	0.40	0.80	0.55	0.80	1	—	CF-2	CF-2
	347	—	—	0.25	0.65	0.50	0.65	1	—	CF-2	CF-2
	480	—	—	0.15	0.45	—	—	2	—	CF-3	—
250	120	1.75	2.70	2.00	2.30	1.20	2.60	1	CF-8	CF-10	CF-8
	208	1.00	1.50	1.10	1.40	0.65	1.50	2	CF-5	CF-6	CF-5
	240	0.85	1.30	1.00	1.20	0.60	1.30	2	CF-5	CF-6	CF-5
	277	0.75	1.15	0.80	1.00	0.50	1.12	1	CF-5	CF-5	CF-3
	347	0.60	0.93	0.62	0.90	0.80	0.90	1	CF-5	CF-3	CF-3
	480	0.40	0.65	0.30	0.60	—	—	2	CF-2	CF-3	—
400	120	3.10	3.90	3.10	3.70	3.25	4.00	1	CF-15	CF-12	CF-10
	208	1.80	2.25	1.70	2.10	1.90	2.30	2	CF-8	CF-6	CF-8
	240	1.60	1.95	1.50	1.90	1.65	2.00	2	CF-5	CF-6	CF-5
	277	1.35	1.70	1.30	1.60	1.40	1.75	1	CF-5	CF-5	CF-5
	347	1.00	1.32	1.10	1.35	1.20	1.40	1	CF-5	CF-5	CF-5
	480	0.80	1.00	0.80	0.95	—	—	2	CF-5	CF-3	—

Fuse Kit includes fuse, fuse holder and necessary hardware for field installation. Mounts easily in ballast body with one screw. Order one fuse for 120 and 277 V, and 2 fuses for 208, 240 and 480 V. CF-2 = 2 amp; CF-3 = 3 amp; CF-5 = 5 amp; CF-6 = 6 amp; CF-8 = 8 amp; CF-10 = 10 amp; CF-12 = 12 amp

① 50 through 150 W HPS have H.P.F. High Reactance ballasts; 250 W and 400 W HPS have CWA ballasts.

② Mercury vapor and metal halide luminaires are not available for purchase within the United States. Please check with your countries governing legislation regarding allowable lamp types before ordering.

# Code•Master™ 2 HID Factory Sealed Luminaires

Explosionproof, Dust-Ignitionproof

Hazardous Locations. For use with threaded metal conduit.

Integrally Ballasted. 50 W, 70 W, 100 W, 150 W, 250 W, 400 W HPS; 175 W, 250 W, 400 W PSMH; 175 W, 250 W, 400 W MH.





NEC: Class I, Division 1 and 2, Groups C, D | Class II, Division 1 and 2, Groups E, F, G | Class III | Marine Type Electric Fixtures Outside Type (Salt Water)

CEC: Class I, Division 1 and 2, Groups B, C, D | Class I, Zone 1 and 2; IIB, IIA | Class II, Division 1, Groups E, F, G | Class II, Division 2, Groups F, G | Class III | CSA Type 4X | Exd IIB, Zone 1

Catalog Number for Ballast Body and Globe | Indicate voltage desired by adding voltage suffix to fixture unit catalog number listed below.

Type	Lamp Watts	Fixture Unit Number	Add Voltage Suffixes ① ②		
			120/208/240/277	120/277/347	480 V
High Pressure Sodium High Power Factor (Min. P.F. 90%)	50	<b>CMBL50</b>	<b>MT</b>	<b>TT</b>	—
	70	<b>CMBL70</b>	<b>MT</b>	<b>TT</b>	<b>48</b>
	100	<b>CMBL100</b>	<b>MT</b>	<b>TT</b>	<b>48</b>
	150	<b>CMBL150</b>	<b>MT</b>	<b>TT</b>	<b>48</b>
	250	<b>CMBL250</b>	<b>MT</b>	<b>TT</b>	<b>48</b>
	400	<b>CMBL400</b>	<b>MT</b>	<b>TT</b>	<b>48</b>
Pulse Start Metal Halide Constant Wattage (Min. P.F. 90%)	175	<b>CMBP175</b>	<b>MT</b>	<b>TT</b>	<b>48</b>
	250	<b>CMBP250</b>	<b>MT</b>	<b>TT</b>	<b>48</b>
	400	<b>CMBP400</b>	<b>MT</b>	<b>TT</b>	<b>48</b>
Metal Halide ③ Constant Wattage (Min. P.F. 90%)	175	<b>CMBH175</b>	<b>MT</b>	<b>TT</b>	<b>C6</b>
	250	<b>CMBH250</b>	<b>MT</b>	<b>TT</b>	<b>C6</b>
	400	<b>CMBH400</b>	<b>MT</b>	<b>TT</b>	<b>C6</b>

## Mounting Hoods

	Hub Size (Inches)	Catalog Number
<b>Pendant — One Hub</b>		
	3/4	<b>CAP-75</b>
	1	<b>CAP-100</b>
<b>Ceiling — Four Hubs, Three Close-Up Plugs</b>		
	3/4	<b>CAC-75</b>
	1	<b>CAC-100</b>
<b>Bracket — Four Hubs, Three Close-Up Plugs</b>		
	3/4	<b>CALB-75</b>
	1	<b>CALB-100</b>
<b>25° Stanchion — One Hub</b>		
	1-1/4 or 1-1/2	<b>CAS-150</b>
	1-1/2" Tapped hub furnished with 1-1/2" to 1-1/4" reducer	
<b>Mounting Adapter with Connection Block</b>		
	Permits use of existing A-51 mounting hoods (AAC Ceiling or AALB Bracket) with the new Code•Master 2 Fixture Unit. After removing existing fixture unit and adapter, screw in the new CMAD-1 Adapter. Then thread new fixture unit into the CMAD-1.	
	<b>CMAD-1</b>	

① Change voltage suffix **-TT** to **-MT** for 120/208/240/277 V, or **-C7** for 600 V. These voltage suffixes have CSA Certification only. Consult factory for other available voltages.

② See "Options" in the "Catalog Numbering Guide" for optional accessories.

③ Mercury vapor and metal halide luminaires are not available for purchase within the United States. Please check with your countries governing legislation regarding allowable lamp types before ordering.

◆ Shaded items are suitable for Class I, Group D ONLY.

# Code•Master™ 2 HID Factory Sealed Luminaires

Explosionproof, Dust-Ignitionproof









Hazardous Locations. For use with threaded metal conduit.

Integrally Ballasted. 50 W, 70 W, 100 W, 150 W, 250 W, 400 W HPS; 175 W, 250 W, 400 W PSMH; 175 W, 250 W, 400 W MH.

NEC: Class I, Division 1 and 2, Groups C, D | Class II, Division 1 and 2, Groups E, F, G | Class III | Marine Type Electric Fixtures Outside Type (Salt Water)

CEC: Class I, Division 1 and 2, Groups B, C, D | Class I, Zone 1 and 2; IIB, IIA | Class II, Division 1, Groups E, F, G | Class II, Division 2, Groups F, G | Class III | CSA Type 4X | Exd IIB, Zone 1

HID Luminaires | Area / Task | Explosionproof, Hazardous Location | NEC / CEC

		Description	Catalog Number
<b>Polyester Reflectors — 50 W - 400 W</b>			
 		Standard Dome	CMR-4ST
		Deep Dome ①	CMR-4DD
		30° Angle	CMR-4AN
Standard and Deep Dome	30° Angle		
<b>Aluminum High Bay Reflectors — 50 W - 400 W</b>			
			CMR-4HB
<b>Prismatic Glass Globes — 50 W - 400 W</b>			
 		50, 70, 100, 150 W HPS; 175, 250 W PSMH; 175, 250 W MH	CGL-250
		250, 400 W HPS; 400 W PSMH; 400 W MH	CGL-400
<b>Aluminum Guards — 50 W - 400 W</b>			
 		50, 70, 100, 150 W HPS; 175, 250 W PSMH; 175, 250 W MH	CGU2
		250, 400 W HPS; 400 W PSMH; 400 W MH	CGU4
<b>Replacement Sockets — 50 W - 400 W (Mogul Base)</b>			
 		For all Code•Master 2 HID fixtures	CMS-400
		Connection Block – 50 W through 400 W For all Code•Master 2 HID fixtures	VPT-7
<b>Quartz Emergency Option for Pulse Start Metal Halide and High Pressure Sodium Fixtures</b>			
Fixtures can be supplied with a socket to accept a 150 W or 250 W, 120 V quartz lamp (lamp not included). This D.C. bayonet base socket is in addition to the standard lamp socket, independent of the lighting fixture voltage.			Add suffix -E

① Fixtures when used with Deep Dome Reflectors are NOT UL Listed.

# Code•Master™ 2 HID Factory Sealed Luminaires

Explosionproof, Dust-Ignitionproof

Hazardous Locations. For use with threaded metal conduit.

Integrally Ballasted. 50 W, 70 W, 100 W, 150 W, 250 W, 400 W HPS; 175 W, 250 W, 400 W PSMH; 175 W, 250 W, 400 W MH.

NEC: Class I, Division 1 and 2, Groups C, D | Class II, Division 1 and 2, Groups E, F, G | Class III | Marine Type Electric Fixtures Outside Type (Salt Water)

CEC: Class I, Division 1 and 2, Groups B, C, D | Class I, Zone 1 and 2; IIB, IIA | Class II, Division 1, Groups E, F, G | Class II, Division 2, Groups F, G | Class III | CSA Type 4X | Exd IIB, Zone 1

## Dimensions in Millimeters (Inches)

### Pendant

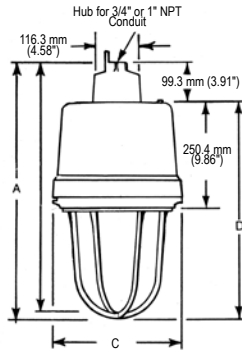

### Ceiling

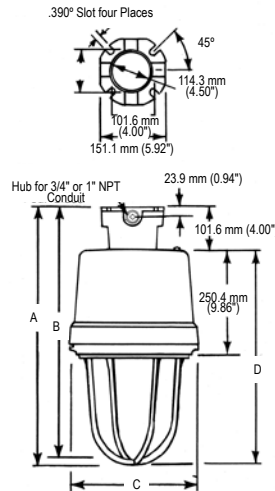

### Bracket

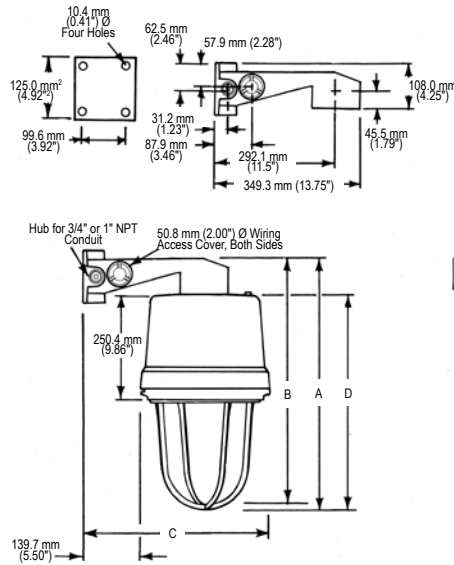

### 25° Stanchion

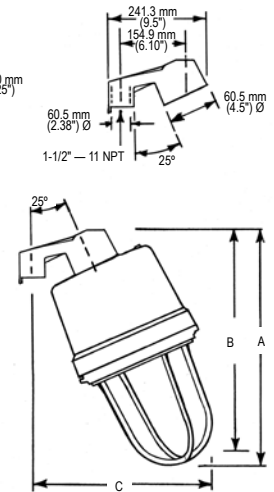

	Pendant				Ceiling				Bracket				25° Stanchion		
	A	B	C	D	A	B	C	D	A	B	C	D	A	B	C
50-250 W ①	546.1 (21.50)	520.7 (20.50)	304.8 (12.00)	447.3 (17.61)	548.9 (21.61)	523.5 (20.61)	304.8 (12.00)	447.3 (17.61)	555.2 (21.86)	529.8 (20.86)	444.5 (17.50)	447.3 (17.61)	495.3 (19.50)	475.0 (18.70)	406.4 (16.00)
250-400 W ②	522.3 (24.50)	596.9 (23.50)	304.8 (12.00)	507.1 (20.36)	618.7 (24.36)	507.1 (20.36)	304.8 (12.00)	507.1 (20.36)	625.1 (24.61)	599.7 (23.61)	444.5 (17.50)	507.1 (20.36)	563.9 (22.20)	538.5 (21.20)	444.5 (17.50)

## Reflector Dimensions in Millimeters (Inches)

### Standard

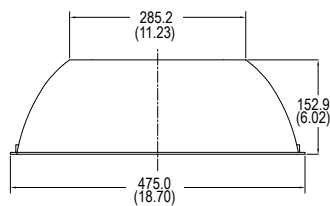

### Deep Dome ③

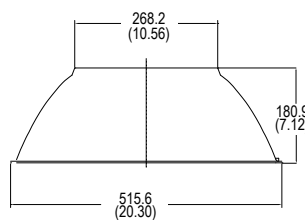

### 30° Angle

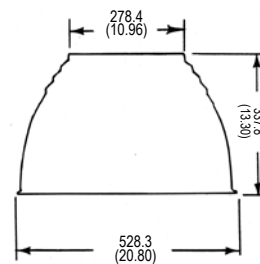

### High Bay

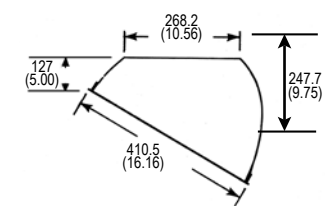

## Fixture and Accessory Weights kg (lb)

Fixture Size	Fixture Weight	Reflector Weight	Guard Weight
50 W through 175 W	14.5 (31.97)	1.4 (3.09)	0.5 (1.10)
250 W PSMH/MH	16.9 (37.26)	1.4 (3.09)	0.5 (1.10)
250 W HPS	18.1 (39.90)	1.4 (3.09)	0.9 (1.98)
400 W PSMH, 400 W MH	20.4 (44.97)	1.4 (3.09)	0.9 (1.98)

## Mounting Hood Weights kgs (lbs)

Pendant	Ceiling	Bracket	Stanchion
0.9 (2)	1.8 (4)	2.7 (6)	0.9 (2)

① 50, 70, 100 and 150 W HPS; 175 W PSMH; 175 and 250 W MH.

② 250 and 400 W HPS; 250, and 400 W PSMH; 400 W MH.

③ Fixtures when used with Deep Dome Reflectors are NOT UL Listed.



# Code•Master™ 2 HID Factory Sealed Luminaires

Explosionproof, Dust-Ignitionproof

Hazardous Locations. For use with threaded metal conduit.

Integrally Ballasted. 50 W, 70 W, 100 W, 150 W, 250 W, 400 W HPS; 175 W, 250 W, 400 W PSMH; 175 W, 250 W, 400 W MH.

NEC: Class I, Division 1 and 2, Groups C, D | Class II, Division 1 and 2, Groups E, F, G | Class III | Marine Type Electric Fixtures Outside Type (Salt Water)

CEC: Class I, Division 1 and 2, Groups B, C, D | Class I, Zone 1 and 2; IIB, IIA | Class II, Division 1, Groups E, F, G | Class II, Division 2, Groups F, G | Class III | CSA Type 4X | Exd IIB, Zone 1

HID Luminaires | Area / Task | Explosionproof, Hazardous Location | NEC / CEC

## Photometric Data

REPORT NUMBER: **CL10G**

Lamps: 100 W High Pressure Sodium with Globe only

**TOTAL LUMINAIRE EFFICIENCY = 76.4%**

**CIE TYPE - SEMI-DIRECT**

Plane	Spacing Criteria
0-180	2.66
90-270	2.66
Diagonal	2.84

Zone	Lumens
0-10	29.80
10-20	106.54
20-30	202.92
30-40	318.52
40-50	468.31
50-60	670.49
60-70	866.67
70-80	976.61
80-90	1038.41
90-100	1042.18
100-110	927.00
110-120	551.82
120-130	51.82
130-140	2.51
140-150	0.25
150-160	0.00
160-170	0.00
170-180	0.00

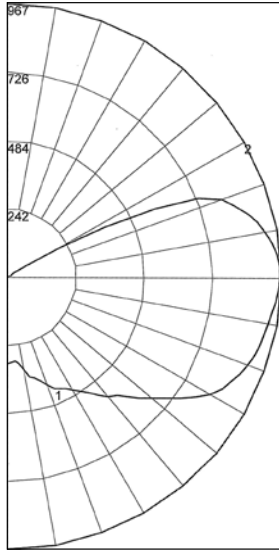

## COEFFICIENTS OF UTILIZATION - ZONAL CAVITY METHOD

EFFECTIVE FLOOR CAVITY REFLECTANCE 0.20

% Ceiling % Walls	Rcc Rw	80				70				50			30			10			0			
		70	50	30	10	70	50	30	10	50	30	10	50	30	10	50	30	10	50	30	10	
0		84	84	84	84	79	79	79	79	70	70	70	61	61	61	53	53	53	49			
1		72	66	61	56	66	61	57	52	53	49	46	45	42	40	38	36	34	30			
2		63	54	47	41	58	51	44	39	43	38	34	37	32	29	30	27	24	21			
3		56	46	38	32	52	43	36	30	36	31	26	31	26	22	25	22	18	15			
4		51	40	32	26	47	37	30	24	31	25	21	26	22	18	22	18	14	12			
5		46	35	27	21	42	32	25	20	28	22	17	23	18	14	19	15	12	9			
6		42	31	23	18	39	29	22	17	24	19	14	21	16	12	17	13	10	7			
7		39	28	20	15	36	26	19	14	22	16	12	18	14	10	15	11	8	6			
8		36	25	18	13	33	23	17	12	20	14	10	17	12	9	14	10	7	5			
9		33	23	16	11	31	21	15	11	18	13	9	15	11	8	13	9	6	4			
10		31	21	14	10	29	19	13	9	17	12	8	14	10	7	12	8	6	4			

## ZONAL LUMEN SUMMARY

Zone	Lumens	% Lamp	% Fixture	Zone	Lumens	% Lamp	% Fixture
0-30	339.26	3.6	4.7	90-120	2521.83	26.5	34.8
0-40	657.79	6.9	9.1	90-130	2572.83	27.1	35.5
0-60	1796.59	18.9	24.8	90-150	2575.59	27.1	35.5
0-90	4678.28	49.2	64.5	90-180	2575.59	27.1	35.5
				0-180	7253.87	76.4	100.0

REPORT NUMBER: **CL10ST**

Lamps: 100 W High Pressure Sodium with Standard Dome Reflector

**TOTAL LUMINAIRE EFFICIENCY = 71.3%**

**CIE TYPE - DIRECT**

Plane	Spacing Criteria
0-180	1.54
90-270	1.54
Diagonal	1.66

Zone	Lumens
0-10	40.00
10-20	331.02
20-30	660.22
30-40	934.51
40-50	1131.33
50-60	1272.76
60-70	1322.68
70-80	826.95
80-90	254.44
90-100	0.00
100-110	0.00
110-120	0.00
120-130	0.00
130-140	0.00
140-150	0.00
150-160	0.00
160-170	0.00
170-180	0.00

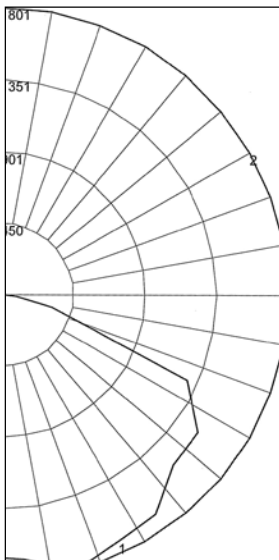

## COEFFICIENTS OF UTILIZATION - ZONAL CAVITY METHOD

EFFECTIVE FLOOR CAVITY REFLECTANCE 0.20

% Ceiling % Walls	Rcc Rw	80				70				50			30			10			0			
		70	50	30	10	70	50	30	10	50	30	10	50	30	10	50	30	10	50	30	10	
0		85	85	85	85	83	83	83	83	79	79	79	76	76	76	73	73	73	71			
1		76	71	68	64	74	70	66	63	67	64	61	64	61	59	61	59	57	56			
2		67	60	54	49	65	59	53	49	56	51	47	54	50	46	51	48	45	43			
3		60	51	44	39	58	50	44	38	48	42	38	46	41	37	44	40	36	34			
4		54	44	37	31	52	43	36	31	41	35	31	40	34	30	38	33	30	28			
5		49	39	31	26	48	38	31	26	36	30	25	35	29	25	33	29	25	23			
6		45	34	27	22	43	33	27	22	32	26	21	31	25	21	30	25	21	19			
7		41	30	23	19	40	30	23	18	29	23	18	28	22	18	27	22	18	16			
8		38	27	21	16	37	27	20	16	26	20	16	25	20	16	24	19	16	14			
9		35	25	18	14	34	24	18	14	24	18	14	23	18	14	22	17	14	12			
10		33	23	17	12	32	22	16	12	22	16	12	21	16	12	20	15	12	11			

## ZONAL LUMEN SUMMARY

Zone	Lumens	% Lamp	% Fixture	Zone	Lumens	% Lamp	% Fixture
0-30	1031.23	10.9	15.2	90-120	0.00	0.0	0.0
0-40	1965.74	20.7	29.0	90-130	0.00	0.0	0.0
0-60	4369.83	46.0	64.5	90-150	0.00	0.0	0.0
0-90	6773.90	71.3	100.0	90-180	0.00	0.0	0.0
				0-180	6773.90	71.3	100.0

\* Photometric data is based on a 100-watt clear HPS lamp (9,500 lumens). For candlepower values of fixtures with other lamps, use the following multipliers: 50 W HPS - 0.42 (4,000 lumens); 70 W HPS - 0.61 (6,300 lumens); and 150 W HPS - 1.68 (16,000 lumens).



# Code•Master™ 2 HID Factory Sealed Luminaires

Explosionproof, Dust-Ignitionproof

Hazardous Locations. For use with threaded metal conduit.

Integrally Ballasted. 50 W, 70 W, 100 W, 150 W, 250 W, 400 W HPS; 175 W, 250 W, 400 W PSMH; 175 W, 250 W, 400 W MH.

NEC: Class I, Division 1 and 2, Groups C, D | Class II, Division 1 and 2, Groups E, F, G | Class III | Marine Type Electric Fixtures Outside Type (Salt Water)

CEC: Class I, Division 1 and 2, Groups B, C, D | Class I, Zone 1 and 2; IIB, IIA | Class II, Division 1, Groups E, F, G | Class II, Division 2, Groups F, G | Class III | CSA Type 4X | Exd IIB, Zone 1

## Photometric Data

REPORT NUMBER: CL10AN

Lamps: 100 W High Pressure Sodium with 30° Angle Dome Reflector

TOTAL LUMINAIRE EFFICIENCY = 61.9%

CIE TYPE - DIRECT

Plane	Spacing Criteria
0-180	1.96
90-270	1.62
Diagonal	1.50

Zone	Lumens
0-10	34.59
10-20	289.50
20-30	587.71
30-40	825.38
40-50	944.04
50-60	952.84
60-70	900.69
70-80	740.88
80-90	607.55
90-100	0.00
100-110	0.00
110-120	0.00
120-130	0.00
130-140	0.00
140-150	0.00
150-160	0.00
160-170	0.00
170-180	0.00

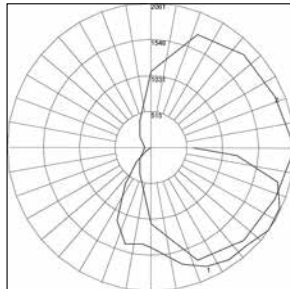

## COEFFICIENTS OF UTILIZATION - ZONAL CAVITY METHOD

EFFECTIVE FLOOR CAVITY REFLECTANCE 0.20

% Ceiling	Rcc	80				70				50			30			10			0
		70	50	30	10	70	50	30	10	50	30	10	50	30	10	50	30	10	
% Walls	0	74	74	74	74	72	72	72	72	69	69	69	66	66	66	63	63	63	62
	1	64	60	56	53	62	59	55	52	56	53	50	53	51	49	51	49	47	46
	2	57	51	45	41	55	49	44	40	47	43	39	45	41	38	43	40	37	36
	3	51	43	37	32	50	42	37	32	40	35	31	38	34	31	37	33	30	28
	4	47	38	31	26	45	37	31	26	35	30	26	34	29	25	32	28	25	23
	5	42	33	27	22	41	32	26	22	31	26	21	30	25	21	28	24	21	19
	6	39	29	23	19	38	29	23	18	28	22	18	26	22	18	25	21	18	16
	7	36	26	20	16	35	26	20	16	25	20	16	24	19	16	23	19	15	14
	8	33	24	18	14	32	23	18	14	22	17	14	22	17	14	21	17	13	12
	9	31	22	16	12	30	21	16	12	20	15	12	20	15	12	19	15	12	11
	10	29	20	14	11	28	19	14	11	19	14	11	18	14	11	18	13	11	9

## ZONAL LUMEN SUMMARY

Zone	Lumens	% Lamp	% Fixture	Zone	Lumens	% Lamp	% Fixture
0-30	911.80	9.6	15.5	90-120	0.0	0.0	0.0
0-40	1737.18	18.3	29.5	90-130	0.0	0.0	0.0
0-60	3634.06	38.3	61.8	90-150	0.0	0.0	0.0
0-90	5883.18	61.9	100.0	90-180	0.0	0.0	0.0
				0-180	5883.18	61.9	100.0

REPORT NUMBER: CL10DD

Lamps: 100 W High Pressure Sodium with Deep Dome Reflector

TOTAL LUMINAIRE EFFICIENCY = 37.8%

CIE TYPE - DIRECT

Plane	Spacing Criteria
0-180	1.36
90-270	1.36
Diagonal	1.54

Zone	Lumens
0-10	26.07
10-20	224.04
20-30	437.71
30-40	551.18
40-50	656.83
50-60	743.35
60-70	592.81
70-80	265.53
80-90	94.52
90-100	0.00
100-110	0.00
110-120	0.00
120-130	0.00
130-140	0.00
140-150	0.00
150-160	0.00
160-170	0.00
170-180	0.00

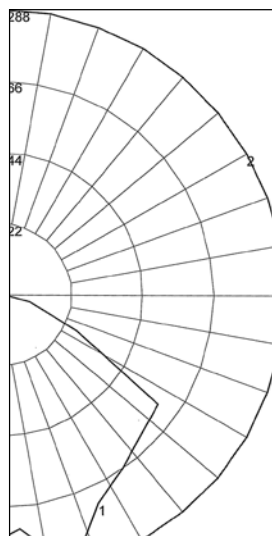

## COEFFICIENTS OF UTILIZATION - ZONAL CAVITY METHOD

EFFECTIVE FLOOR CAVITY REFLECTANCE 0.20

% Ceiling	Rcc	80				70				50			30			10			0
		70	50	30	10	70	50	30	10	50	30	10	50	30	10	50	30	10	
% Walls	0	45	45	45	45	44	44	44	44	42	42	42	40	40	40	39	39	39	38
	1	41	39	37	35	40	38	36	35	36	35	34	35	34	33	33	32	32	31
	2	37	33	30	28	36	32	30	28	31	29	27	30	28	26	29	27	26	25
	3	33	29	25	22	32	28	25	22	27	24	22	26	23	21	25	23	21	20
	4	30	25	21	18	29	24	21	18	23	20	18	22	20	18	22	19	18	17
	5	27	22	18	15	26	21	18	15	21	17	15	20	17	15	19	17	15	14
	6	25	19	16	13	24	19	16	13	18	15	13	18	15	13	17	15	13	12
	7	23	17	14	11	22	17	14	11	16	13	11	16	13	11	15	13	11	10
	8	21	16	12	10	21	15	12	10	15	12	10	14	12	10	14	11	10	9
	9	20	14	11	9	19	14	11	9	13	11	9	13	10	8	13	10	8	8
	10	18	13	10	8	18	13	10	8	12	10	8	12	9	8	12	9	7	7

## ZONAL LUMEN SUMMARY

Zone	Lumens	% Lamp	% Fixture	Zone	Lumens	% Lamp	% Fixture
0-30	687.82	7.2	19.1	90-120	0.0	0.0	0.0
0-40	1239.00	13.0	34.5	90-130	0.0	0.0	0.0
0-60	2639.18	27.8	73.5	90-150	0.0	0.0	0.0
0-90	3592.04	37.8	100.0	90-180	0.0	0.0	0.0
				0-180	3592.04	37.8	100.0

\* Photometric data is based on a 100-watt clear High Pressure Sodium lamp (9,500 lumens). For candlepower values of fixtures with other lamps, use the following multipliers: 50 W HPS - 0.42 (4,000 lumens); 70 W HPS - 0.61 (6,300 lumens); and 150 W HPS - 1.68 (16,000 lumens).

# Code•Master™ 2 HID Factory Sealed Luminaires

Explosionproof, Dust-Ignitionproof

Hazardous Locations. For use with threaded metal conduit.

Integrally Ballasted. 50 W, 70 W, 100 W, 150 W, 250 W, 400 W HPS; 175 W, 250 W, 400 W PSMH; 175 W, 250 W, 400 W MH.

NEC: Class I, Division 1 and 2, Groups C, D | Class II, Division 1 and 2, Groups E, F, G | Class III | Marine Type Electric Fixtures Outside Type (Salt Water)  
 CEC: Class I, Division 1 and 2, Groups B, C, D | Class I, Zone 1 and 2; IIB, IIA | Class II, Division 1, Groups E, F, G | Class II, Division 2, Groups F, G | Class III | CSA Type 4X | Exd IIB, Zone 1

HID Luminaires | Area / Task | Explosionproof, Hazardous Location | NEC / CEC

## Photometric Data

REPORT NUMBER: CP40G

Lamps: 400 W Pulse Start Metal Halide with Globe only

**TOTAL LUMINAIRE EFFICIENCY = 81.9%**

CIE TYPE - GENERAL DIFFUSE

Zone	Lumens
0-10	161.29
10-20	470.38
20-30	918.96
30-40	1511.24
40-50	2242.10
50-60	3052.29
60-70	3653.41
70-80	4255.87
80-90	4603.15
90-100	4476.83
100-110	4007.91
110-120	3380.83
120-130	2599.55
130-140	672.85
140-150	18.11
150-160	2.59
160-170	1.21
170-180	0.65

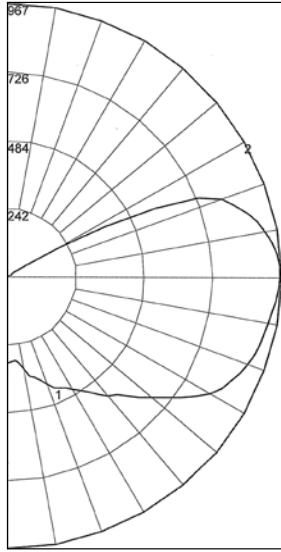

## COEFFICIENTS OF UTILIZATION - ZONAL CAVITY METHOD

EFFECTIVE FLOOR CAVITY REFLECTANCE 0.20

% Ceiling % Walls	Rcc Rw	80				70				50			30			10			0			
		70	50	30	10	70	50	30	10	50	30	10	50	30	10	50	30	10	50	30	10	
0		89	89	89	89	83	83	83	83	72	72	72	61	61	61	52	52	52	47			
1		76	70	65	60	70	65	60	56	55	51	48	46	43	40	38	35	33	29			
2		67	59	51	45	62	54	48	42	45	40	36	37	33	30	30	27	24	20			
3		60	50	42	36	55	46	39	33	39	33	28	32	27	23	25	22	19	15			
4		55	43	35	29	50	40	32	27	33	27	23	27	22	19	22	18	15	12			
5		50	38	30	24	45	35	28	22	29	23	19	24	19	15	19	15	12	9			
6		45	34	26	20	41	31	24	18	26	20	16	21	16	13	17	13	10	8			
7		42	30	22	17	38	28	21	16	23	18	13	19	14	11	15	11	9	6			
8		39	27	20	15	35	25	18	14	21	15	12	17	13	9	14	10	7	5			
9		36	25	18	13	33	23	16	12	19	14	10	16	11	8	13	9	6	5			
10		33	22	16	11	31	21	15	10	18	12	9	15	10	7	12	8	6	4			

## ZONAL LUMEN SUMMARY

Zone	Lumens	% Lamp	% Fixture	Zone	Lumens	% Lamp	% Fixture
0-30	1550.63	3.5	4.3	90-120	11865.57	27.0	32.9
0-40	3061.87	7.0	8.5	90-130	14465.12	32.9	40.1
0-60	8356.25	19.0	23.2	90-150	15156.08	34.4	40.1
0-90	20868.68	47.4	57.9	90-180	15160.53	34.5	42.1
				0-180	36029.22	81.9	100.0

REPORT NUMBER: CP40ST

Lamps: 400 W Pulse Start Metal Halide with Standard Dome Reflector

**TOTAL LUMINAIRE EFFICIENCY = 70.4%**

CIE TYPE - DIRECT

Plane	Spacing Criteria
0-180	1.46
90-270	1.46
Diagonal	1.70

Zone	Lumens
0-10	595.04
10-20	1709.44
20-30	2776.90
30-40	3730.18
40-50	4573.20
50-60	5290.95
60-70	5418.07
70-80	5086.12
80-90	1757.09
90-100	33.71
100-110	0.00
110-120	0.00
120-130	0.00
130-140	0.00
140-150	0.00
150-160	0.00
160-170	0.00
170-180	0.00

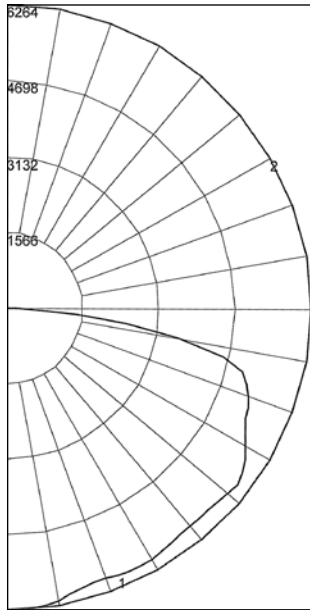

## COEFFICIENTS OF UTILIZATION - ZONAL CAVITY METHOD

EFFECTIVE FLOOR CAVITY REFLECTANCE 0.20

% Ceiling % Walls	Rcc Rw	80				70				50			30			10			0			
		70	50	30	10	70	50	30	10	50	30	10	50	30	10	50	30	10	50	30	10	
0		84	84	84	84	82	82	82	82	78	78	78	75	75	75	72	72	72	70			
1		74	69	65	62	72	68	64	60	64	61	58	62	59	57	59	57	55	53			
2		65	58	52	47	63	57	51	46	54	49	45	51	47	44	49	46	43	41			
3		58	49	42	37	57	48	42	36	46	40	36	44	39	35	42	38	34	32			
4		53	43	35	30	51	42	35	30	40	34	29	38	33	29	36	32	28	26			
5		48	38	30	25	46	37	30	25	35	29	24	34	28	24	32	27	24	22			
6		44	33	26	21	43	33	26	21	31	25	21	30	25	21	29	24	20	19			
7		41	30	23	18	39	29	23	18	28	22	18	27	22	18	26	21	18	16			
8		38	27	21	16	37	27	20	16	26	20	16	25	19	16	24	19	15	14			
9		35	25	18	14	34	24	18	14	23	18	14	23	18	14	22	17	14	12			
10		33	23	17	13	32	22	17	13	22	16	13	21	16	12	20	16	12	11			

## ZONAL LUMEN SUMMARY

Zone	Lumens	% Lamp	% Fixture	Zone	Lumens	% Lamp	% Fixture
0-30	5081.38	11.5	16.4	90-120	33.71	0.1	0.1
0-40	8811.56	20.0	28.5	90-130	33.71	0.1	0.1
0-60	18675.71	42.4	60.3	90-150	33.71	0.1	0.1
0-90	30936.99	70.3	99.9	90-180	33.71	0.1	0.1
				0-180	30970.7	70.4	100.0

\* Photometric data is based on a 400-watt clear Pulse Start Metal Halide lamp (34,000 lumens). For candlepower values of fixtures with other lamps, use the following multipliers: 400 W HPS - 1.13 (50,000 lumens); and 250 W HPS - 0.68 (30,000 lumens).

# Code•Master™ 2 HID Factory Sealed Luminaires

Explosionproof, Dust-Ignitionproof

Hazardous Locations. For use with threaded metal conduit.

Integrally Ballasted. 50 W, 70 W, 100 W, 150 W, 250 W, 400 W HPS; 175 W, 250 W, 400 W PSMH; 175 W, 250 W, 400 W MH.

NEC: Class I, Division 1 and 2, Groups C, D | Class II, Division 1 and 2, Groups E, F, G | Class III | Marine Type Electric Fixtures Outside Type (Salt Water)

CEC: Class I, Division 1 and 2, Groups B, C, D | Class I, Zone 1 and 2; IIB, IIA | Class II, Division 1, Groups E, F, G | Class II, Division 2, Groups F, G | Class III | CSA Type 4X | Exd IIB, Zone 1

## Photometric Data

REPORT NUMBER: CP40AN

Lamps: 400 W Pulse Start Metal Halide with 30° Angle Dome Reflector

TOTAL LUMINAIRE EFFICIENCY = 62.5%

CIE TYPE - DIRECT

Plane	Spacing Criteria
0-180	1.46
90-270	1.46
Diagonal	1.70

Zone	Lumens
0-10	503.08
10-20	1461.14
20-30	2434.06
30-40	3353.43
40-50	3867.50
50-60	3954.40
60-70	3752.38
70-80	3368.71
80-90	2643.39
90-100	1531.50
100-110	421.63
110-120	86.74
120-130	65.68
130-140	20.81
140-150	11.94
150-160	7.93
160-170	4.46
170-180	1.47

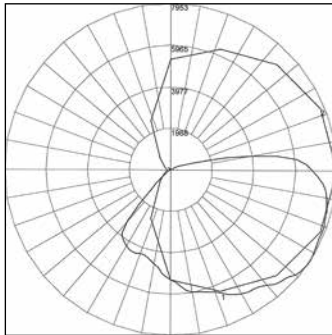

## COEFFICIENTS OF UTILIZATION - ZONAL CAVITY METHOD

EFFECTIVE FLOOR CAVITY REFLECTANCE 0.20

% Ceiling % Walls	Rcc Rw	80				70				50			30			10			0			
		70	50	30	10	70	50	30	10	50	30	10	50	30	10	50	30	10	50	30	10	
0		73	73	73	73	71	71	71	71	67	67	67	63	63	63	59	59	59	58			
1		64	60	56	53	62	58	55	52	54	52	49	51	49	47	48	46	44	42			
2		57	51	45	41	55	49	44	40	46	42	38	43	40	37	40	38	35	33			
3		51	44	38	33	49	42	37	32	39	35	31	37	33	30	35	31	26	27			
4		47	38	32	27	45	37	31	26	35	29	25	32	28	25	30	27	24	22			
5		43	34	27	23	41	33	27	22	31	25	22	29	24	21	27	23	20	19			
6		39	30	24	19	38	29	23	19	27	22	18	26	21	18	24	20	17	16			
7		36	27	21	17	35	26	21	17	25	20	16	23	19	16	22	18	15	14			
8		34	24	19	15	32	24	18	15	22	18	14	21	17	14	20	16	13	12			
9		31	22	17	13	30	22	16	13	21	16	13	20	15	12	19	15	12	11			
10		29	20	15	12	28	20	15	12	19	14	11	18	14	11	17	13	11	10			

## ZONAL LUMEN SUMMARY

Zone	Lumens	% Lamp	% Fixture	Zone	Lumens	% Lamp	% Fixture
0-30	4398.28	10.0	16.0	90-120	2039.87	4.6	7.4
0-40	7751.71	17.6	28.2	90-130	2105.55	4.8	7.7
0-60	15573.61	35.4	56.7	90-150	2138.30	4.9	7.7
0-90	25338.08	57.6	92.2	90-180	2152.16	4.9	7.8
				0-180	27490.24	62.5	100.0

REPORT NUMBER: CP40DD

Lamps: 400 W Pulse Start Metal Halide with Deep Dome Reflector

TOTAL LUMINAIRE EFFICIENCY = 69.1%

CIE TYPE - DIRECT

Plane	Spacing Criteria
0-180	1.46
90-270	1.46
Diagonal	1.70

Zone	Lumens
0-10	676.92
10-20	1962.51
20-30	3199.12
30-40	4281.42
40-50	4889.12
50-60	5408.09
60-70	5456.18
70-80	3822.90
80-90	693.25
90-100	20.14
100-110	0.00
110-120	0.00
120-130	0.00
130-140	0.00
140-150	0.00
150-160	0.00
160-170	0.00
170-180	0.00

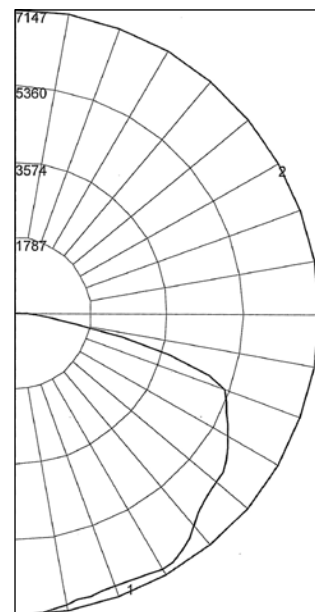

## COEFFICIENTS OF UTILIZATION - ZONAL CAVITY METHOD

EFFECTIVE FLOOR CAVITY REFLECTANCE 0.20

% Ceiling % Walls	Rcc Rw	80				70				50			30			10			0			
		70	50	30	10	70	50	30	10	50	30	10	50	30	10	50	30	10	50	30	10	
0		82	82	82	82	80	80	80	80	77	77	77	73	73	73	70	70	70	69			
1		74	70	66	63	72	68	65	62	65	63	60	63	60	58	60	58	57	55			
2		66	59	54	49	64	58	53	49	55	51	47	53	49	46	51	48	45	44			
3		59	51	44	39	57	50	44	39	48	42	38	46	41	38	44	40	37	35			
4		54	44	38	32	52	43	37	32	42	36	32	40	35	31	38	34	31	29			
5		49	39	32	27	47	38	32	27	37	31	27	35	30	26	34	29	26	24			
6		45	35	28	23	44	34	28	23	33	27	23	32	26	23	30	26	22	21			
7		41	31	24	20	40	31	24	20	30	24	20	29	23	20	28	23	19	18			
8		38	28	22	18	37	28	22	18	27	21	17	26	21	17	25	21	17	16			
9		36	26	20	16	35	25	20	16	25	19	16	24	19	15	23	19	15	14			
10		34	24	18	14	33	23	18	14	23	18	14	22	17	14	21	17	14	12			

## ZONAL LUMEN SUMMARY

Zone	Lumens	% Lamp	% Fixture	Zone	Lumens	% Lamp	% Fixture
0-30	5838.56	13.3	19.2	90-120	20.14	0.0	0.1
0-40	10119.98	23.0	33.3	90-130	20.14	0.0	0.1
0-60	20417.19	46.4	67.1	90-150	20.14	0.0	0.1
0-90	30389.51	69.1	99.9	90-180	20.14	0.0	0.1
				0-180	30409.65	69.1	100.0

\* Photometric data is based on a 400-watt clear Pulse Start Metal Halide lamp (34,000 lumens). For candlepower values of fixtures with other lamps, use the following multipliers: 400 W HPS - 1.13 (50,000 lumens); and 250 W HPS - 0.68 (30,000 lumens).

# Code•Master™ 2 HID Factory Sealed Luminaires

Explosionproof, Dust-Ignitionproof

Hazardous Locations. For use with threaded metal conduit.

Integrally Ballasted. 50 W, 70 W, 100 W, 150 W, 250 W, 400 W HPS; 175 W, 250 W, 400 W PSMH; 175 W, 250 W, 400 W MH.

NEC: Class I, Division 1 and 2, Groups C, D | Class II, Division 1 and 2, Groups E, F, G | Class III | Marine Type Electric Fixtures Outside Type (Salt Water)  
 CEC: Class I, Division 1 and 2, Groups B, C, D | Class I, Zone 1 and 2; IIB, IIA | Class II, Division 1, Groups E, F, G | Class II, Division 2, Groups F, G | Class III | CSA Type 4X | Exd IIB, Zone 1

HID Luminaires | Area / Task | Explosionproof, Hazardous Location | NEC / CEC

## Photometric Data

REPORT NUMBER: CP40HB

Lamps: 400 W Pulse Start Metal Halide with High Bay Reflector

**TOTAL LUMINAIRE EFFICIENCY = 63.4%**

CIE TYPE - DIRECT

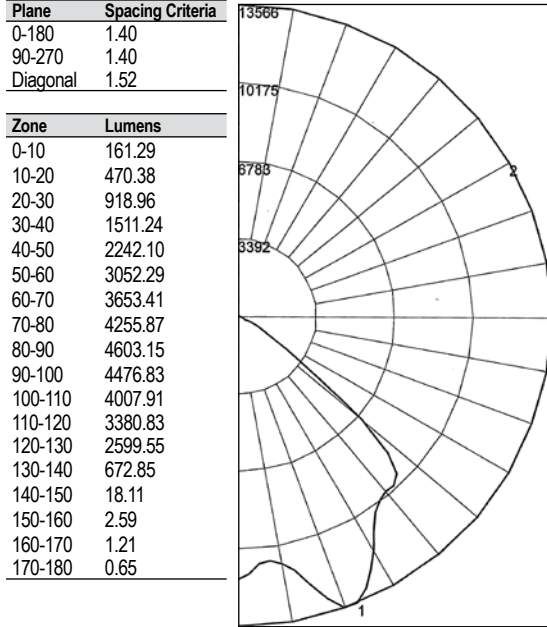

## COEFFICIENTS OF UTILIZATION - ZONAL CAVITY METHOD

EFFECTIVE FLOOR CAVITY REFLECTANCE 0.20

% Ceiling % Walls	Rcc Rw	80				70				50			30			10			0			
		70	50	30	10	70	50	30	10	50	30	10	50	30	10	50	30	10	50	30	10	
0		76	76	76	76	74	74	74	74	70	70	70	67	67	67	65	65	65	63			
1		71	69	67	65	69	67	65	64	65	63	62	62	61	60	60	59	58	57			
2		66	62	59	56	64	61	58	55	59	56	54	57	55	53	55	53	52	50			
3		61	56	52	48	60	55	51	48	53	50	47	51	49	46	50	48	46	44			
4		57	50	46	42	55	50	45	42	48	44	42	47	44	41	45	43	40	39			
5		53	46	41	37	51	45	40	37	44	40	37	43	39	36	42	38	36	35			
6		49	42	37	33	48	41	36	33	40	36	33	39	35	32	38	35	32	31			
7		46	38	33	30	44	37	33	29	37	32	29	36	32	29	35	31	29	28			
8		42	35	30	27	42	34	30	26	34	29	26	33	29	26	32	29	26	25			
9		40	32	27	24	39	32	27	24	31	27	24	30	26	24	30	26	24	23			
10		37	29	25	22	36	29	25	22	29	24	22	28	24	22	27	24	21	20			

## ZONAL LUMEN SUMMARY

Zone	Lumens	% Lamp	% Fixture	Zone	Lumens	% Lamp	% Fixture
0-30	10513.00	23.9	37.7	90-120	1.23	0.0	0.0
0-40	17145.58	39.0	61.4	90-130	1.23	0.0	0.0
0-60	27133.29	61.7	97.2	90-150	1.23	0.0	0.0
0-90	27904.30	63.4	100.0	90-180	1.23	0.0	0.0
				0-180	27905.53	63.4	100.0

\* Photometric data is based on a 400-watt clear Pulse Start Metal Halide lamp (34,000 lumens). For candlepower values of fixtures with other lamps, use the following multipliers: 400 W HPS - 1.13 (50,000 lumens); and 250 W HPS - 0.68 (30,000 lumens).