

# ALPF Factory Sealed Lighting – APPF Power Distribution Panelboards

## Explosionproof, Dust-Ignitionproof, Watertight

### NEC:

Class I, Division 1 and 2, Groups B♦, C♦, D

Class II, Division 1 and 2, Groups E, F, G

Class III

Class I, Zone 1, Group IIB +H<sub>2</sub>

NEMA 4, 4X, 7BCD, 9EFG

### Applications

- Distribution panelboards are used to furnish protection and control of electrical equipment in hazardous locations. These compact units provide a centrally controlled switching system for large quantities of branch circuits for:
  - Lighting
  - Heating
  - Small motors
  - Similar electrical equipment

### Features

- Breaker operators included as standard.
- O-ring gasket insures watertight integrity.
- Factory sealed, no external seals are required for most branch circuits. All conduits must be sealed adjacent to enclosure for Class I, Division 1, Groups B and C.
- Breakers are housed in the panel section and prewired to maximum circuit capacity, then wired to numbered terminals in the wiring compartment.
- Terminal compartment is interconnected to panel section with sealing hubs, unions and poured with sealing compound.
- Permits selection of 1-, 2- or 3-pole breakers.
- Precision machined flame path between body and cover.
- Bolt on stainless steel slotted mounting feet.
- Breaker operators can be padlocked in the ON or OFF position.
- All panelboards are supplied with Cutler-Hammer<sup>+</sup> interiors.
- Chassis assemblies with mains at top (bottom optional).
- Provisions for 12, 18, 24, 30, 36 and 42 circuit 1-pole chassis.
- 100 Amp or 225 Amp main lug.
- Up to 100 Amp backfed main breaker available with main lug chassis.
- Up to 225 Amp main breaker available with main breaker chassis.
- Factory installed ground and neutral bar as standard.

### Standard Materials

- Bodies and covers: copperfree (4/10 of 1% max.) aluminum
- Cover bolts: Quad-Lead<sup>®</sup>, captive, stainless steel
- Breaker operators: copperfree (4/10 of 1% max.) aluminum
- Hinges: stainless steel
- Bus bars: copper
- O-ring: neoprene

### Standard Finish

- Corrosion resistant gray epoxy powder coat to provide NEMA 4X rating

### Options

Must be listed in alphanumeric sequence at the end of the catalog number.

- Panel Options
  - Breather, NEMA 4X add suffix —**BR**.
  - Drain, NEMA 4X add suffix —**DN**.
  - External ground stud add suffix —**EGS**.
  - Grounding neutral lug add suffix —**GNL**.
  - Terminal breaker located at bottom, add suffix —**INV**.
  - Main breaker located at bottom, add suffix —**LB**.
  - Phenolic nameplate (specify legend) add suffix —**NP**.
  - For 50 °C (122 °F) breaker rating, add suffix —**V**.
  - For stainless steel terminal enclosure for Division 2 applications only, contact your local sales representative.

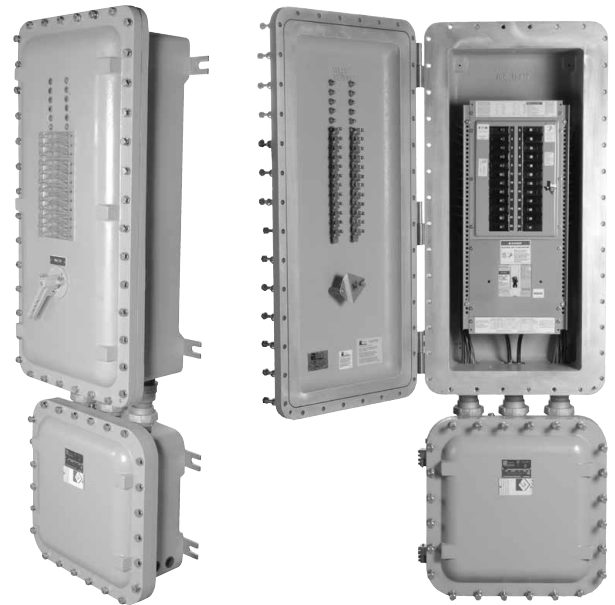

- Main Breaker Options
  - Auxiliary switch (1A or 1B) add suffix —**AS1**.
  - Auxiliary switch (2A or 2B) add suffix —**AS2**.
  - Shunt trip (specify voltage) add suffix —**ST**.
  - Under voltage release (specify voltage) add suffix —**UV**.
- Branch Breaker Option ALPF Only
  - Equipment Protection Devices (1- or 2-Pole -30 mA sensitivity) ① add suffix —**EPD**.
  - Ground Fault Interrupter (1- or 2-Pole -5 mA sensitivity) ① add suffix —**GFI**.
  - GFI Indicating Light add suffix —**L5**.
- Branch Breaker Options APPF GHB Only
  - Equipment Protection Devices (1- or 2-Pole -30 mA sensitivity) ① add suffix —**EPD**.
- Branch Breaker Options APPF F-Frame Only
  - Auxiliary switch (1A or 1B) add suffix —**AS1**.
  - Auxiliary switch (2A or 2B) add suffix —**AS2**.
  - Shunt trip (specify voltage) add suffix —**ST**.
  - Under voltage release (specify voltage) add suffix —**UV**.
- 400 Amp panel available, contact your local sales representative.

### NEC Certifications and Compliances

- UL Standard: UL 1203
- UL Classified: E84577

♦ For Class I, Division 1, Groups B and C, all conduits must be sealed within 50.8 mm (2") of enclosure.

+ Cutler-Hammer is a trademark of the Eaton Corporation.

① GFI Push-to-Test Buttons are standard with GFI or EPD options.

# ALPF Lighting Factory Sealed Distribution Panelboards

Explosionproof, Dust-Ignitionproof, Watertight

**NEC:**  
 Class I, Division 1 and 2, Groups B♦, C♦, D  
 Class II, Division 1 and 2, Groups E, F, G  
 Class III  
 Class I, Zone 1, Group IIB +H<sub>2</sub>  
 NEMA 4, 4X, 7BCD, 9EFG

Select branch breakers as desired in panel. First and second digits are the quantity of breakers, third and fourth digits are ampere rating, the fifth digit is number of poles. Example: An 18 circuit 120/240 V 1-phase 3-wire 225 Amp Main panel with 12 1-pole 20 Amp and 3 2-pole 30 Amp branch breakers should read ALPFM21A18MB225-10501GFI.

## Catalog Numbering Guide

ALPF	M	2	1	A	18	MB	225	10	50	1	GFI	▲	
Duty: Appleton Factory Sealed Lighting Panel			Voltage: 1 - 120/240 2 - 120/208 5 - 240 Vdc 7 - 24 Vdc 8 - 125/250 Vdc			Main Type: MB - Main Breaker ML - Main Lug Only			Ampere Rating ①: 10 - 10AT 15 - 15AT 20 - 20AT 25 - 25AT 30 - 30AT 35 - 35AT 40 - 40AT 45 - 45AT 50 - 50AT 55 - 55AT 60 - 60AT 70 - 70AT 80 - 80AT (not for 1-Pole) 90 - 90AT (not for 1-Pole) 100 - 100AT			Additional Branch Breakers: Repeat Step ①	
Panel Size: J - 12 Circuit, 100 Amp Main Lug Only K - 18 Circuit, 100 Amp Main Lug Only M - 30 Circuit, 100 or 225 Amp Main Lug Only or 18 Circuit with Main Breaker N - 42 Circuit, 225 Amp Main Lug Only or 36 Circuit with Main Breaker Q - 42 Circuit with Main Breaker			Wire System: A - 1P, 3W B - 3P, 3W for 240 Vdc C - 3P, 4W D - 2P, 2W for 24 Vdc			Ampere Rating: 020 - 20AT 025 - 25AT 030 - 30AT 040 - 40AT 050 - 50AT 060 - 60AT 070 - 70AT 080 - 80AT 090 - 90AT 100 - 100AT 110 - 110AT 125 - 125AT 150 - 150AT 175 - 175AT 200 - 200AT 225 - 225AT			No. of Poles ①: (include only if different from wiring system)			Suffix for Other Options/ Features: Must be listed in alphanumeric sequence (See Options)	
		Current Rating: 1 - 100 Amp 2 - 225 Amp			Number of Circuits: 12 18 24 30 36 42		Quantity of Branch Breakers ①: 1 thru 42			Breaker Type ①: Normal Duty (Leave Blank) EPD GFI HID			

♦ For Class I, Division 1, Groups B and C, all conduits must be sealed within 50.8 mm (2") of enclosure.

▲ Suffix for Other Options/Features: Must be listed in alphanumeric sequence. See Options.

# ALPF Lighting Factory Sealed Distribution Panelboards

## Explosionproof, Dust-Ignitionproof, Watertight

NEC:  
 Class I, Division 1 and 2, Groups B♦, C♦, D  
 Class II, Division 1 and 2, Groups E, F, G  
 Class III  
 Class I, Zone 1, Group IIB +H<sub>2</sub>  
 NEMA 4, 4X, 7BCD, 9EFG

	Number of Circuits	120/240 Volt 1-Phase 3-Wire BAB Type	120/208 Volt 3-Phase 4-Wire BAB Type	240V 3-Phase 3-Wire Delta BAB Type	Panel Size	Approx. Weight (lbs)
100 Amp Main Lug Only	12	ALPFJ11A12ML ▲	ALPFJ12C12ML ▲	ALPFJ15C12ML ▲	J	121.11/267
	18	ALPFK11A18ML ▲	ALPFK12C18ML ▲	ALPFK15C18ML ▲	K	134.72/297
	24	ALPFM11A24ML ▲	ALPFM12C24ML ▲	ALPFM15C24ML ▲	M	155.13/342
	30	ALPFM11A30ML ▲	ALPFM12C30ML ▲	ALPFM15C30ML ▲	M	157.40/347
225 Amp Main Lug Only	18	ALPFM21A18ML ▲	ALPFM22C18ML ▲	ALPFM25C18ML ▲	M	141.52/312
	24	ALPFM21A24ML ▲	ALPFM22C24ML ▲	ALPFM25C24ML ▲	M	164.20/362
	30	ALPFM21A30ML ▲	ALPFM22C30ML ▲	ALPFM25C30ML ▲	M	166.47/367
	36	ALPFN21A36ML ▲	ALPFN22C36ML ▲	ALPFN25C36ML ▲	N	191.42/422
	42	ALPFN21A42ML ▲	ALPFN22C42ML ▲	ALPFN25C42ML ▲	N	193.68/427
Main Breaker 100AF	12	ALPFM11A12MB100 ▲	ALPFM12C12MB100 ▲	ALPFM15C12MB100 ▲	M	134.72/297
	18	ALPFM11A18MB100 ▲	ALPFM12C18MB100 ▲	ALPFM15C18MB100 ▲	M	141.52/312
	24	ALPFN11A24MB100 ▲	ALPFN12C24MB100 ▲	ALPFN15C24MB100 ▲	N	193.68/427
	30	ALPFN11A30MB100 ▲	ALPFN12C30MB100 ▲	ALPFN15C30MB100 ▲	N	202.56/447
Main Breaker 225AF	18	ALPFM21A18MB225 ▲	ALPFM22C18MB225 ▲	ALPFM25C18MB225 ▲	M	143.79/317
	24	ALPFN21A24MB225 ▲	ALPFN22C24MB225 ▲	ALPFN25C24MB225 ▲	N	193.68/427
	30	ALPFN21A30MB225 ▲	ALPFN22C30MB225 ▲	ALPFN25C30MB225 ▲	N	195.95/432
	36	ALPFN21A36MB225 ▲	ALPFN22C36MB225 ▲	ALPFN25C36MB225 ▲	N	198.22/437
	42	ALPFQ21A42MB225 ▲	ALPFQ22C42MB225 ▲	ALPFQ25C42MB225 ▲	Q	202.56/447

Note: For Back Fed main, replace **ML**, **MB100**, or **MB225** in part number with **BF**. For 400 Amp Main Lug, contact your local representative. Standard interrupting capacity is 14,000 AIC. For higher interrupt ratings, contact your local representative.

### Typical Panelboard Wiring Diagram

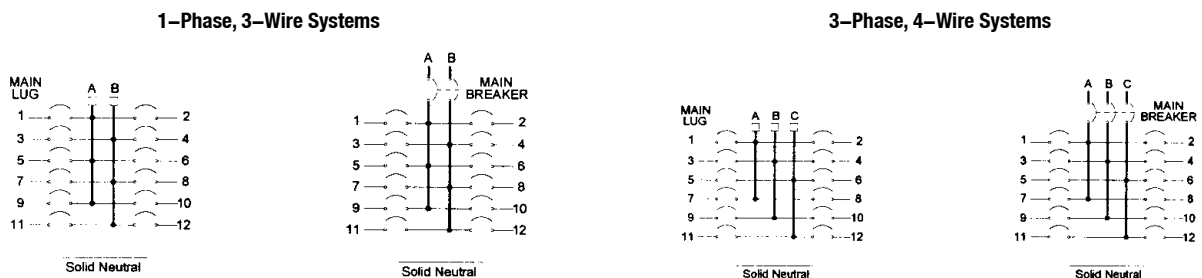

Panel	Sealed Together	
J	161606	161606/08
K	162206	161606/08
M	162806	161606/08
N	153707	161606/08
Q	184207	181806/08

♦ For Class I, Division 1, Groups B and C, all conduits must be sealed within 50.8 mm (2") of enclosure.  
 ▲ Suffix for Other Options/Features: Must be listed in alphanumeric sequence. See Options.

# APPF Series Power Distribution Panelboards

Explosionproof, Dust-Ignitionproof, Watertight

GHB Cutler-Hammer + Circuit Breakers

**NEC:**

Class I, Division 1 and 2, Groups B♦, C♦, D

Class II, Division 1 and 2, Groups E, F, G

Class III

Class I, Zone 1, Group IIB +H<sub>2</sub>

NEMA 4, 4X, 7BCD, 9EFG

Select GHB + branch breakers as desired in panel. First and second digits are the quantity of breakers, third and fourth digits are ampere rating, the fifth digit is number of poles. Example: An 18-circuit 277/480 V 3-phase 4-wire 100 A MLO panel with 12 1-pole 20 Amp and 3 2-pole 30 Amp branch breakers should read APPFK14C18ML100-12201EPD-03302.

**Catalog Numbering Guide**

<p><b>APPF</b></p> <p>Duty: Appleton Factory Sealed Power Panel</p>	<p><b>K</b></p> <p>Panel Size: J - 12 Circuit, 100 Amp Main Lug Only K - 18 Circuit, 100 Amp Main Lug Only M - 30 Circuit, 100 or 225 Amp Main Lug Only or 18 Circuit with Main Breaker N - 42 Circuit, 225 Amp Main Lug Only or 36 Circuit with Main Breaker Q - 42 Circuit with Main Breaker</p>	<p><b>1</b></p> <p>Current Rating: 1 - 100 Amp 2 - 225 Amp</p>	<p><b>4</b></p> <p>Voltage: 4 - 277/480 (3P 4W Only) 7 - 24 Vdc 8 - 125/250 Vdc</p>	<p><b>C</b></p> <p>Wire System: C - 3P, 4W D - 2P, 2W for 24 Vdc</p>	<p><b>18</b></p> <p>Number of Circuits: 12 18 24 30 36 42</p>	<p><b>ML</b></p> <p>Main Type: MB - Main Breaker ML - Main Lug Only</p>	<p><b>100</b></p> <p>Ampere Rating: 020 - 20AT 025 - 25AT 030 - 30AT 040 - 40AT 050 - 50AT 060 - 60AT 070 - 70AT 080 - 80AT 090 - 90AT 100 - 100AT 110 - 110AT 125 - 125AT 150 - 150AT 175 - 175AT 200 - 200AT 225 - 225AT</p>	<p><b>12</b></p> <p>Quantity of Branch Breakers ①: 1 thru 42</p>	<p><b>20</b></p> <p>Ampere Rating ①: 15 - 15AT 20 - 20AT 25 - 25AT 30 - 30AT 35 - 35AT 40 - 40AT 45 - 45AT 50 - 50AT 55 - 55AT 60 - 60AT 70 - 70AT 80 - 80AT 90 - 90AT 100 - 100AT</p>	<p><b>1</b></p> <p>No. of Poles ①: (include only if different from wiring system)</p>	<p><b>EPD</b></p> <p>Breaker Type ①: Normal Duty (Leave Blank) EPD ①</p>	<p><b>—</b></p> <p>Additional Branch Breakers: Repeat Step ①</p>	<p><b>▲</b></p> <p>Suffix for Other Options/ Features: Must be listed in alphanumeric sequence (See Options)</p>
---	--	--	---	--	---	---	--	--	--	---	--	--	--

① EPD Single Phase (requires 2-Poles) 277 Vac, 30 mA.

♦ For Class I, Division 1, Groups B and C, all conduits must be sealed within 50.8 mm (2") of enclosure.

▲ Suffix for Other Options/Features: Must be listed in alphanumeric sequence. See Options.

+ GHB and Cutler-Hammer are trademarks of the Eaton Corporation.

DISTRIBUTION EQUIPMENT: NEC/CEC HAZARDOUS LOCATION PANELBOARDS

Appleton®

# APPF Series Power Distribution Panelboards

## Explosionproof, Dust-Ignitionproof, Watertight

GHB Cutler-Hammer + Circuit Breakers

**NEC:**

Class I, Division 1 and 2, Groups B♦, C♦, D

Class II, Division 1 and 2, Groups E, F, G

Class III

Class I, Zone 1, Group IIB +H<sub>2</sub>

NEMA 4, 4X, 7BCD, 9EFG

	Number of Circuits	277/480 Volt 3-Phase 4-Wire GHB Type	Panel Size	Approximate Weight kgs (lbs)
100 Amp Main Lug Only	12	APPFJ14C12ML ▲	J	61.23 (135)
	18	APPFK14C18ML ▲	K	74.84 (165)
	24	APPFM14C24ML ▲	M	95.25 (210)
	30	APPFM14C30ML ▲	M	97.52 (215)
225 Amp Main Lug Only	18	APPFM24C18ML ▲	M	81.65 (180)
	24	APPFM24C24ML ▲	M	104.33 (230)
	30	APPFM24C30ML ▲	M	106.59 (235)
	36	APPFN24C36ML ▲	N	131.54 (290)
	42	APPFN24C42ML ▲	N	133.81 (295)
Main Breaker 100 Amp F	12	APPFM14C12MB100 ▲	M	74.84 (165)
	18	APPFM14C18MB100 ▲	M	81.65 (180)
	24	APPFN14C24MB100 ▲	N	95.25 (210)
	30	APPFN14C30MB100 ▲	N	142.88 (315)
Main Breaker 225 Amp F	18	APPFM24C18MB225 ▲	M	83.91 (185)
	24	APPFN24C24MB225 ▲	N	133.81 (295)
	30	APPFN24C30MB225 ▲	N	136.08 (300)
	36	APPFN24C36MB225 ▲	N	138.35 (305)
	42	APPFQ24C42MB225 ▲	Q	156.49 (345)

Note: For Back Fed main, replace **ML**, **MB100**, or **MB225** in part number with **BF**. For 400 Amp Main Lug, contact your local representative. Standard interrupting capacity is 14,000 AIC. For higher interrupt ratings, contact your local representative.

### Typical Panelboard Wiring Diagram

#### 3-Phase, 4-Wire Systems

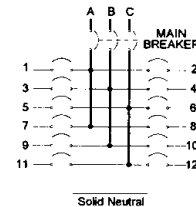
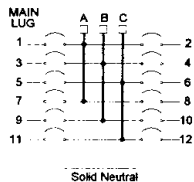

- ♦ For Class I, Division 1, Groups B and C, all conduits must be sealed within 50.8 mm (2") of enclosure.
- ▲ Suffix for Other Options/Features: Must be listed in alphanumeric sequence. See Options.
- + GHB and Cutler-Hammer are trademarks of the Eaton Corporation.

# APPF 480, 600 Volt Factory Sealed Power Distribution Panelboards

## Explosionproof, Dust-Ignitionproof, Watertight

F-Frame Cutler Hammer + Circuit Breakers

**NEC:**  
 Class I, Division 1 and 2, Groups B♦, C♦, D  
 Class II, Division 1 and 2, Groups E, F, G  
 Class III  
 Class I, Zone 1, Group IIB +H<sub>2</sub>  
 NEMA 4, 4X, 7BCD, 9EFG

Select branch breakers as desired in panel. First and second digits are the quantity of breakers, third and fourth digits are ampere rating, the fifth digit is number of poles. Example: An 18-circuit 277/480 V 3-phase 100 A MLO panel with 12 1-pole 20 Amp and 3 2-pole 30 Amp branch breakers should read APPFP14C18ML100-12201-03302.

### Catalog Numbering Guide

APPF	P	1	4	C	18	ML	100	12	20	1	▲
Duty: Appleton Factory Sealed Power Panel			Voltage: 3 - 480 4 - 277/480 6 - 600 7 - 24 Vdc 8 - 125/250 Vdc			Main Type: MB - Main Breaker ML - Main Lug Only			Ampere Rating ①: 10 - 10AT 15 - 15AT 20 - 20AT 25 - 25AT 30 - 30AT 35 - 35AT 40 - 40AT 45 - 45AT 50 - 50AT 60 - 60AT 70 - 70AT 80 - 80AT 90 - 90AT 100 - 100AT 110 - 110AT (2-, 3-Pole Only) 125 - 125AT (2-, 3-Pole Only) 150 - 150AT (2-, 3-Pole Only) 175 - 175AT (2-, 3-Pole Only) 200 - 200AT (2-, 3-Pole Only)		Suffix for Other Options/ Features: Must be listed in alphanumeric sequence (See Options)
Panel Size: P - 12 Circuit with Main Breaker or 24 Circuit without Main Breaker R - 24 Circuit with Main Breaker or 36 Circuit without Main Breaker or S - 42 Circuit with or without Main Breaker			Wire System: B - 3P, 3W C - 3P, 4W D - 2P, 2W for 24 Vdc			Ampere Rating: 020 - 20AT 025 - 25AT 030 - 30AT 040 - 40AT 050 - 50AT 060 - 60AT 070 - 70AT 080 - 80AT 090 - 90AT 100 - 100AT 110 - 110AT 125 - 125AT 150 - 150AT 175 - 175AT 200 - 200AT 225 - 225AT			No. of Poles ①: (include only if different from wiring system)		
		Current Rating: 1 - 100 Amp 2 - 225 Amp			Number of Circuits: 12 18 24 30 36 42		Quantity of Branch Breakers ①: 1 thru 42			Additional Branch Breakers: Repeat Step ①	

① EPD Single Phase (requires 2-Poles) 277 Vac, 30 mA.

+ Cutler-Hammer is a trademark of the Eaton Corporation.

♦ For Class I, Division 1, Groups B and C, all conduits must be sealed within 50.8 mm (2") of enclosure.

# APPF 480, 600 Volt Factory Sealed Power Distribution Panelboards

Explosionproof, Dust-Ignitionproof, Watertight

F-Frame Cutler Hammer + Circuit Breakers

**NEC:**

Class I, Division 1 and 2, Groups B♦, C♦, D

Class II, Division 1 and 2, Groups E, F, G

Class III

Class I, Zone 1, Group IIB +H<sub>2</sub>

NEMA 4, 4X, 7BCD, 9EFG

	Number of Circuits	480 V 3-Phase 3-Wire EHD Type	277/480 V 3-Phase 4-Wire EHD Type	600 V 3-Phase 4-Wire FDB Type
100 Amp Main Lug Only	12	APPFP13B12ML ▲	APPFP14C12ML ▲	APPFP16C12ML ▲
	18	APPFP13B18ML ▲	APPFP14C18ML ▲	APPFP16C18ML ▲
	24	APPFP13B24ML ▲	APPFP14C24ML ▲	APPFP16C24ML ▲
	30	APPFR13B30ML ▲	APPFR14C30ML ▲	APPFR16C30ML ▲
225 Amp Main Lug Only	18	APPFP23B18ML ▲	APPFP24C18ML ▲	APPFP26C18ML ▲
	24	APPFR23B24ML ▲	APPFR24C24ML ▲	APPFR26C24ML ▲
	30	APPFR23B30ML ▲	APPFR24C30ML ▲	APPFR26C30ML ▲
	36	APPFR23B36ML ▲	APPFR24C36ML ▲	APPFR26C36ML ▲
	42	APPFS23B42ML ▲	APPFS24C42ML ▲	APPFS26C42ML ▲
Main Breaker 100 Amp F	12	APPFP13B12MB100 ▲	APPFP14C12MB100 ▲	APPFP16C12MB100 ▲
	18	APPFR13B18MB100 ▲	APPFR14C18MB100 ▲	APPFR16C18MB100 ▲
	24	APPFR13B24MB100 ▲	APPFR14C24MB100 ▲	APPFR16C24MB100 ▲
	30	APPFR13B30MB100 ▲	APPFR14C30MB100 ▲	APPFR16C30MB100 ▲
Main Breaker 225 Amp F	18	APPFR23B18MB225 ▲	APPFR24C18MB225 ▲	APPFR26C18MB225 ▲
	24	APPFR23B24MB225 ▲	APPFR24C24MB225 ▲	APPFR26C24MB225 ▲
	30	APPFS23B30MB225 ▲	APPFS24C30MB225 ▲	APPFS26C30MB225 ▲
	36	APPFS23B36MB225 ▲	APPFS24C36MB225 ▲	APPFS26C36MB225 ▲
	42	APPFS23B42MB225 ▲	APPFS24C42MB225 ▲	APPFS26C42MB225 ▲

Note: For Back Fed main, replace **ML**, **MB100**, or **MB225** in part number with **BF**. For 400 Amp Main Lug, contact your local representative. Standard interrupting capacity is 14,000 AIC. For higher interrupt ratings, contact your local representative.

## Typical Panelboard Wiring Diagram

3-Phase, 3-Wire Systems

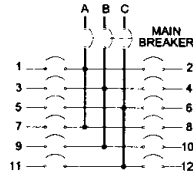
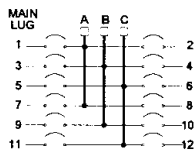

3-Phase, 4-Wire Systems

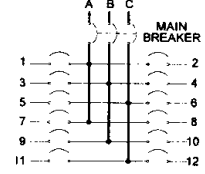
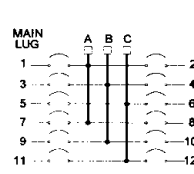

♦ For Class I, Division 1, Groups B and C, all conduits must be sealed within 50.8 mm (2") of enclosure.  
▲ Suffix for Other Options/Features: Must be listed in alphanumeric sequence. See Options.

# ALPF Factory Sealed Lighting – APPF Power Distribution Panelboards

Explosionproof, Dust-Ignitionproof, Watertight

F-Frame Cutler Hammer + Circuit Breakers

NEC:

Class I, Division 1 and 2, Groups B♦, C♦, D

Class II, Division 1 and 2, Groups E, F, G

Class III

Class I, Zone 1, Group IIB +H<sub>2</sub>

NEMA 4, 4X, 7BCD, 9EFG

DISTRIBUTION EQUIPMENT: NEC/CEC HAZARDOUS LOCATION PANELBOARDS

## ALPF and APPF (GHB Type) Factory Sealed Distribution Panelboard

Panel Size	Sealed Together		Top Outlets	Side Outlets	Mounting Hdw. Set
N	153707	161606/08	(1) 3" and (8) 1" NPT	(4) 1" NPT	AMH8
Q	184207	181806/08	(1) 3" and (8) 1" NPT	(4) 1" NPT	AMH8

## Dimensions in Millimeters (Inches)

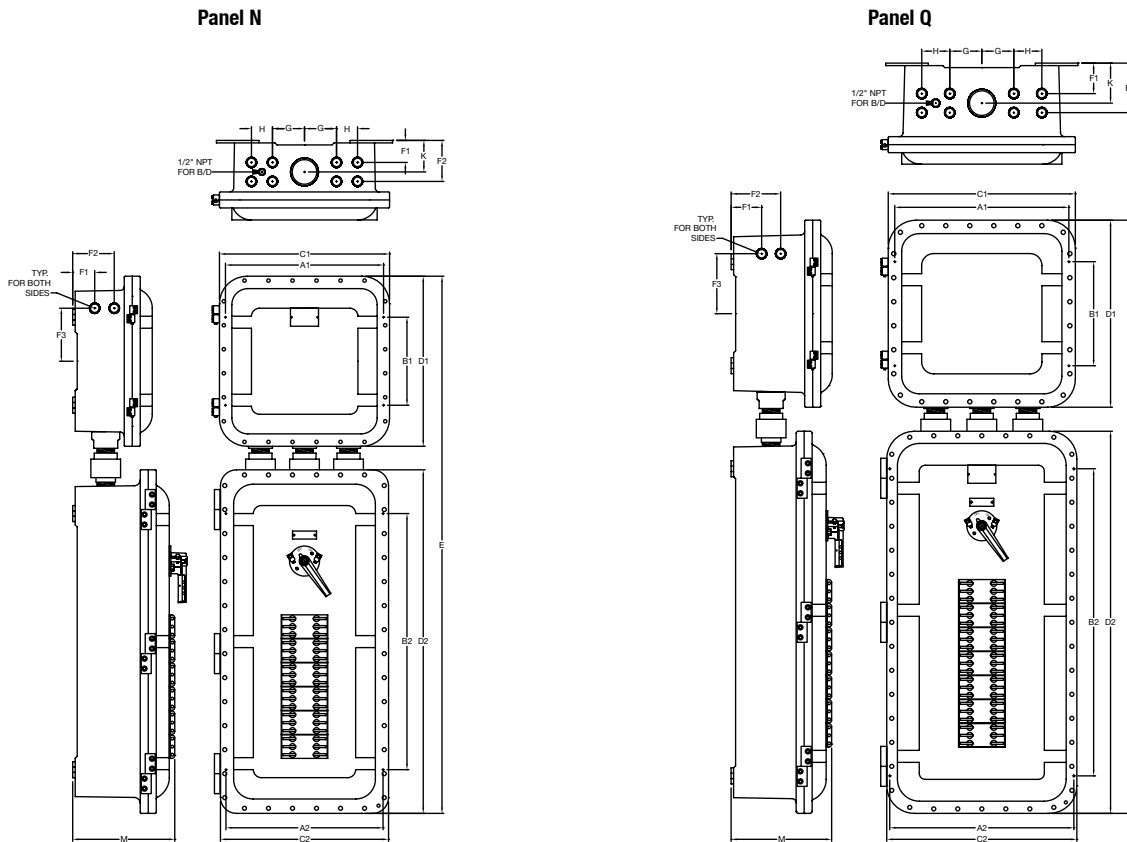

Panel Size	A1	A2	B1	B2	C1	C2	D1	D2	E	F1	F2	G	H	K	M
N	501.7 (19.75)	498.6 (19.63)	279.4 (11.00)	812.8 (32.00)	539.8 (21.25)	533.4 (21.00)	539.8 (21.25)	1090.7 (42.94)	1705.1 (67.13)	69.9 (2.75)	130.3 (5.13)	101.6 (4.00)	66.8 (2.63)	100.1 (3.94)	330.2 (13.00)
Q	552.5 (21.75)	584.2 (23.00)	330.2 (13.00)	974.9 (38.38)	593.9 (23.38)	603.3 (23.75)	593.9 (23.38)	1212.9 (47.75)	1882.9 (74.13)	96.8 (3.81)	157.2 (6.19)	101.6 (4.00)	88.9 (3.50)	127.0 (5.00)	325.4 (12.81)

♦ For Class I, Division 1, Groups B and C, all conduits must be sealed within 50.8 mm (2") of enclosure.



# ALPF Factory Sealed Lighting – APPF Power Distribution Panelboards

## Explosionproof, Dust-Ignitionproof, Watertight

**NEC:**  
 Class I, Division 1 and 2, Groups B♦, C♦, D  
 Class II, Division 1 and 2, Groups E, F, G  
 Class III  
 Class I, Zone 1, Group IIB +H<sub>2</sub>  
 NEMA 4, 4X, 7BCD, 9EFG

### ALPF and APPF (GHB Type) Factory Sealed Distribution Panelboard

Panel Size	Sealed Together		Top Outlets	Side Outlets	Mounting Hdw. Set
J	161606	161606/08	(1) 2" and (8) 1" NPT	—	AMH8
K	162206	161606/08	(1) 2" and (8) 1" NPT	—	AMH8
M	162806	161606/08	(1) 3" and (8) 1" NPT	—	AMH8

### Dimensions in Millimeters (Inches)

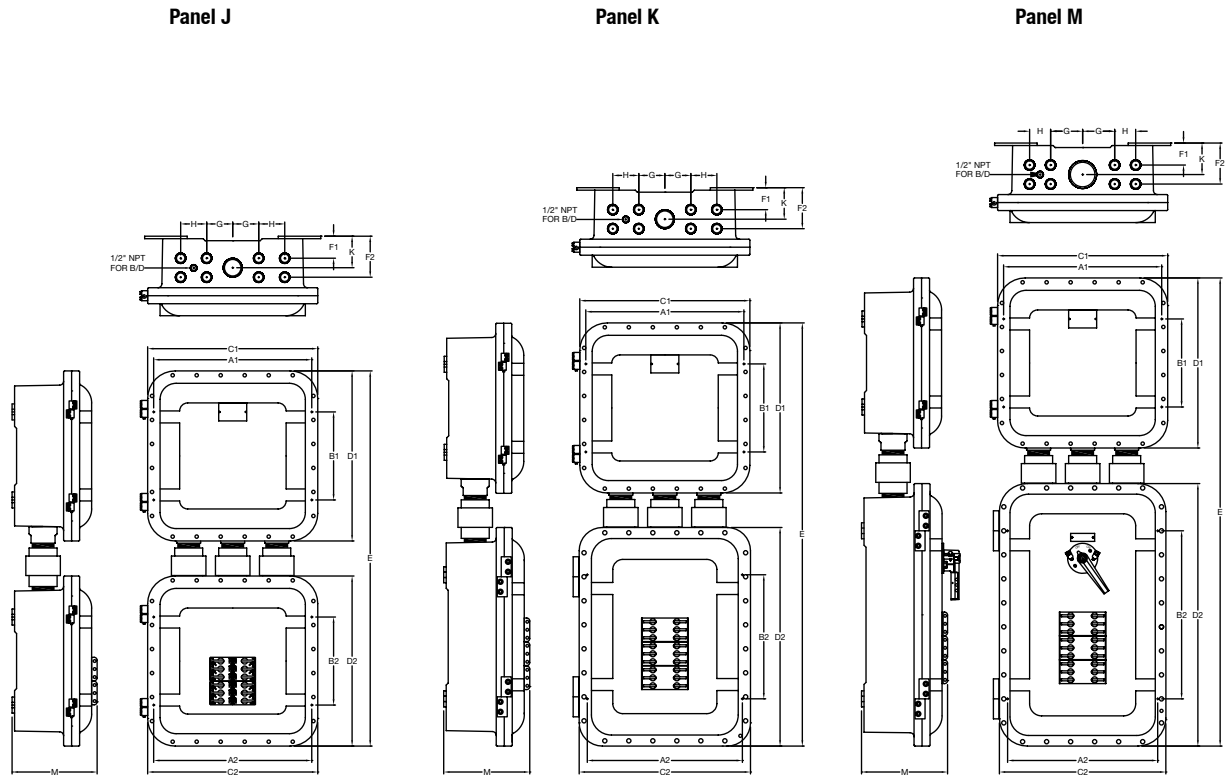

Panel Size	A1	A2	B1	B2	C1	C2	D1	D2	E	F1	F2	G	H	K	M
J	501.7 (19.75)	501.7 (19.75)	279.4 (11.00)	279.4 (11.00)	539.8 (21.25)	539.8 (21.25)	539.8 (21.25)	539.8 (21.25)	1190.8 (46.88)	69.9 (2.75)	130.3 (5.13)	82.6 (3.25)	82.6 (3.25)	100.1 (3.94)	279.4 (11.00)
K	501.7 (19.75)	492.3 (19.38)	279.4 (11.00)	393.7 (15.50)	539.8 (21.25)	543.6 (21.40)	539.8 (21.25)	693.7 (27.31)	1343.2 (52.88)	69.9 (2.75)	130.3 (5.13)	82.6 (3.25)	82.6 (3.25)	100.1 (3.94)	279.4 (11.00)
M	501.7 (19.75)	476.3 (18.75)	279.4 (11.00)	533.4 (21.00)	539.8 (21.25)	528.3 (20.80)	539.8 (21.25)	833.1 (32.80)	1485.9 (58.50)	69.9 (2.75)	130.3 (5.13)	101.6 (4.00)	66.8 (2.63)	100.1 (3.94)	279.4 (11.00)

♦ For Class I, Division 1, Groups B and C, all conduits must be sealed within 50.8 mm (2") of enclosure.

Visit our website at [www.emerson.com](http://www.emerson.com) or contact us at (800) 621-1506.  
 © June 2017

# ALPF Factory Sealed Lighting – APPF Power Distribution Panelboards

Explosionproof, Dust-Ignitionproof, Watertight

F-Frame Cutler Hammer + Circuit Breakers

NEC:  
 Class I, Division 1 and 2, Groups B♦, C♦, D  
 Class II, Division 1 and 2, Groups E, F, G  
 Class III  
 Class I, Zone 1, Group IIB +H<sub>2</sub>  
 NEMA 4, 4X, 7BCD, 9EFG

DISTRIBUTION EQUIPMENT: NEC/CEC HAZARDOUS LOCATION PANELBOARDS

## APPF 480, 600 Volt Factory Sealed Power Distribution Panelboard

Panel Size	Sealed Together	Top	Standard Outlets Sides	Mounting Hdw. Set
P	183608	181806/08	(1) 3" and (8) 1" NPT	CMH8 (2)
R	184806	181806/08	(1) 3" and (8) 1" NPT	CMH8 (2)
S	206008	181806/08	(1) 3" and (8) 1" NPT	CMH8 (2)

### Dimensions in Millimeters (Inches)

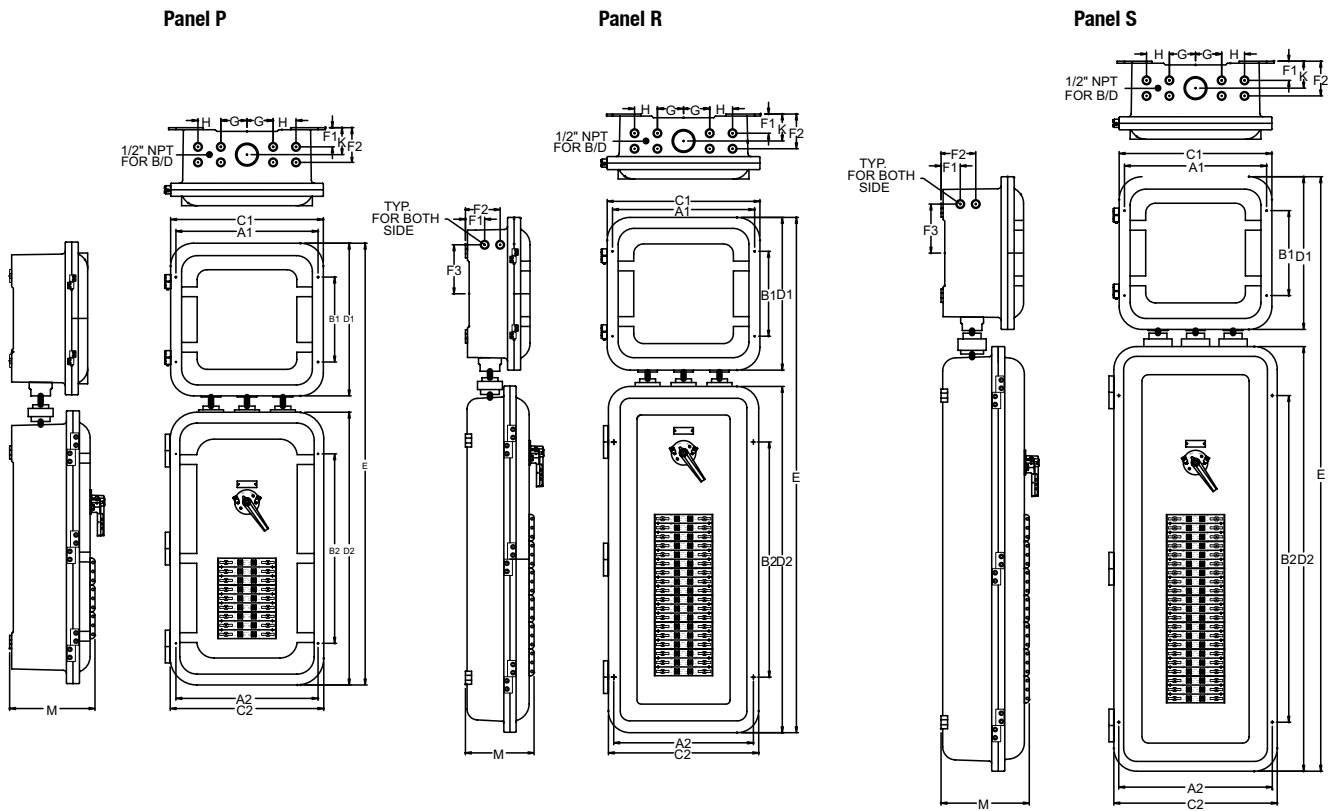

Panel Size	A1	A2	B1	B2	C1	C2	D1	D2	E	F1	F2	F3	G	H	K	M
P	522.5 (21.75)	21.75/ 522.5	330.2 (13.00)	736.6 (29.00)	593.9 (23.38)	596.9 (23.50)	593.9 (23.38)	1060.5 (41.75)	1717.8 (67.63)	74.7 (2.94)	130.3 (5.13)	—	101.6 (4.00)	88.9 (3.50)	104.9 (4.13)	331.7 (13.06)
R	522.5 (21.75)	543.1 (21.38)	330.2 (13.00)	914.4 (36.00)	593.9 (23.38)	584.2 (23.00)	593.9 (23.38)	1346.2 (53.00)	2003.6 (78.88)	74.7 (2.94)	130.3 (5.13)	190.5 (7.50)	101.6 (4.00)	88.9 (3.50)	104.9 (4.13)	266.7 (10.50)
S	522.5 (21.75)	596.9 (23.50)	330.2 (13.00)	1270.0 (50.00)	593.9 (23.38)	635.0 (25.00)	593.9 (23.38)	1651.0 (65.00)	2311.4 (91.00)	74.7 (2.94)	130.3 (5.13)	190.5 (7.50)	101.6 (4.00)	88.9 (3.50)	104.9 (4.13)	331.7 (13.06)

♦ For Class I, Division 1, Groups B and C, all conduits must be sealed within 50.8 mm (2") of enclosure.