

FLOWave SAW-Flowmeter

powered by
EDIP



- No parts in the measurement tube
- Conforms to hygienic requirements
- Ideal for liquids with low or no conductivity
- Digital communication
- Compact, light weight and energy-efficient

Type 8098 can be combined with...



Type 8802-DF
ELEMENT
Continuous system



Type 8802-GD
ELEMENT
Continuous system

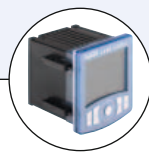

Type 8619
multiCELL
transmitter/controller

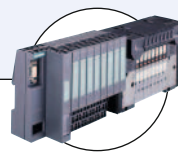

Type 8644
Valve islands

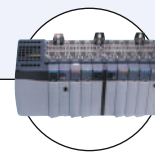

PLC

The 8098 flowmeter is a product of the FLOWave range. It uses the SAW (Surface Acoustic Waves) technology and is designed for the use in applications where all hygienic conditions are fulfilled.

This is achieved by using:

- the suitable stainless steel materials
- a tube free of any inner parts
- the ideal outer design (e.g. without any fixing components such as screws).

The main application focuses on hygienic applications and the measurement or monitoring of liquids similar to water. By way of example, water having a low or zero conductivity is a preferred field of use since the FLOWave flowmeter performs the measurements independently of the conductivity.

FLOWave offers a range of features, including flexibility advantages, ease of cleaning (e.g. CIP and SIP), compact size, light weight, easy installation and handling, and is compliant with numerous standards.

General data	
Type of fluids	Water similar homogeneous liquids, free of air and free of gas bubbles. Non emulsified liquids, no gas, no steam. Kinematic viscosity $\leq 2 \text{ mm}^2/\text{s}$ (2 cSt) Non dangerous liquids complying with article 4, §1 of 2014/68/EU directive (see * on page 3)
Clamp/pipe size acc. to DIN 32676 series B ASME BPE (DIN 32676 series C)	DN15, DN25, DN40 and DN50 $\frac{3}{4}$ ", 1", 1 $\frac{1}{2}$ ", 2"
Materials Wetted parts Measurement tube and clamp Unwetted parts Transmitter and sensor housings Seal / Display Cable glands / Blind plugs M12 male connector and blind plug Pressure compensating element Name plate	Stainless steel 316L/1.4435 BN2 Stainless steel 304/1.4301 VMQ silicone / Float glass, stainless steel 304/1.4301 Nickel plated brass / Black POM Nickel plated brass Diaphragm in ePTFE, support in polyester (PET), o-ring in silicone 60 Shore A, body in aluminium-zinc-alloy with nickel, copper sheathing Metallized polyester
Surface finish¹⁾ Measurement tube (inner surface) Meas. tube (outer surface), housing	Ra < 0.8 μm (30 $\mu\text{in.}$) or Ra < 0.4 μm (15 $\mu\text{in.}$) (electro-polished) Ra < 1.6 μm (excluding welding seams)
Display	2.4", monochrome graphic (240 x 160 pixel) German, English, French languages
Electrical connection	2 cable glands M20 x 1.5 and 1 x 5 pin M12 male fixed connector
Recommended cable for Cable glands M12 female connector (not supplied)	Cable with max. operating temperature of min. 90 °C 5...14 mm diameter, shielded cable, 0.2...1.5 mm ² cross-section, Cable with max. operating temperature of min. 80 °C 3...6.5 mm diameter, shielded cable, 0.75 mm ² cross-section

¹⁾ according to ISO 4288

General data - continued	
Weight (approx. - kg)	DN15 / ¼" DN25 / 1" DN40 / 1 ½" DN50 / 2"
	2.2 2.4 3.2 3.4
Flow rate measurement¹⁾	
Measuring range	0...7 m³/h to 0...90 m³/h (see ordering chart on page 8)
Measurement deviation ²⁾	
from 10 % of F.S.* up to F.S.*	±0.4 % of the measured value
from 1 % of F.S.* up to 10 % F.S.*	< ±0.08 % of F.S.*
Repeatability	
from 10 % of F.S.* up to F.S.*	±0.2 % of the measured value
from 1 % of F.S.* up to 10 % F.S.*	±0.04 % of F.S.*
Refresh time	240 ms
Temperature measurement	
Measuring range	-20...+140 °C (-4...+284 °F)
Measurement deviation ²⁾ for	
T° ≤ 100 °C	±1 °C (1.8 °F)
100 °C < T° < 140 °C	±1.5 %
Fluid temperature (The maximum fluid temperature can be restricted by the ambient operating temperature)	
Measuring range	-20...+110 °C (-4...+230 °F)
Maximum conditions for sterilisation process:	up to +140 °C (284 °F) for 60 min.
Maximum temperature gradient	10 °C/s (18 °F/s) (measured by the integrated sensor on the device)
Fluid nominal pressure max for	
DN15, DN25, ¼", 1", 1 ½"	PN25 (363 PSI)
DN40, DN50, 2"	PN16 (290 PSI)
Electrical data	
Operating voltage	12...35 V DC filtered and regulated, limited energy source (according to paragraph 9.4 of the UL61010-1 standard) Tolerance: ±10 %
Reversed polarity of DC	Protected
Power consumption	Max. 5 W (without any consumption of output)
Outputs	3 (1 digital, 1 analogue and 1 configurable: digital or analogue)
Digital outputs	
Transistor	Overload information (through diagnostic software function) Type: NPN or PNP (wiring dependent), open collector, galvanically isolated; Operating modes: pulse (by default), On/Off, threshold, frequency (user configurable); 0...2 kHz, 5...35 V DC, 700 mA max.; Max. pulse duration: 65 ms; Protected against polarity reversals of DC and overloads
Frequency resolution	0.05 Hz over 0...2 kHz range
Analogue output	
Current	Open loop detection (through diagnostic software function) 4...20 mA; 3.6 mA or 22 mA to indicate an error (only if 4...20 mA scale selected); galvanically isolated; max. loop impedance: 1300 Ω at 35 V DC, 1000 Ω at 30 V DC, 700 Ω at 24 V DC, 450 Ω at 18 V DC
4...20 mA output uncertainty	±0.04 mA
4...20 mA output resolution	0.8 µA
Environment conditions	
Ambient temperature	Depends on the fluid temperature (see drawing)
Operation / Storage	-10...+70 °C (14...+158 °F) / -20...+70 °C (-4...+158 °F)
Relative humidity	< 85 %, without condensation
Height above sea level	max. 2000 m

¹⁾ Under reference conditions i.e. measuring fluid = water, ambient and water temperature = 23 °C (73.4 °F), while maintaining the minimum inlet (40 x DN) and outlet (1 x DN) distances and the appropriate internal diameter of the pipes.

²⁾ = "measurement bias" as defined in the standard JCGM 200:2012

* F.S. = of Full scale (see ordering chart on page 8)

Ambient and fluid temperatures

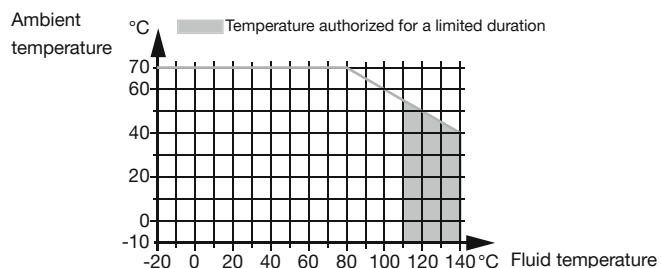

8098 FLOWave

bürkert

Standards, directives and certifications	
Protection class	IP65, IP67 (according to EN60529), NEMA 4X (according to NEMA250), if the product is wired and if the cable glands are tightened and the covers are screwed tight. Unused cable glands must be sealed with the stopper gaskets provided (mounted at the delivery of the product). Unused M12 male fixed connector must be protected with the screwed plug.
Standards and directives CE	The applied standards, which verify conformity with the EU Directives, can be found on the EU Type Examination Certificate and/or the EU Declaration of conformity (if applicable). Complying with article 4, §1 of 2014/68/EU directive*
Certificates	EHEDG (Type EL - CLASS I) ¹⁾ ; 3A (28-04); Inspection certificate 3.1; Certification of compliance ASME BPE; Calibration certificate; On request: Test report 2.2 for surface finish
Certification UL-Listed for US and Canada 	UL61010-1 + CAN/CSA-C22.2 No.61010-1 (pending)
Specific technical data of UL-listed products for US and Canada	
Intended for an inner pollution	Pollution degree 2, according to EN61010-1
Installation category	Category II, according to UL61010-1

* For the 2014/68/EU pressure directive, the device can only be used under the following conditions (depends on max. pressure, pipe diameter and fluid).

Type of Fluid	Conditions
Fluid group 1, article 4, §1.c.i	DN ≤ 25
Fluid group 2, article 4, §1.c.i	DN ≤ 32 or PN*DN ≤ 1000
Fluid group 1, article 4, §1.c.ii	DN ≤ 25 or PN*DN ≤ 2000
Fluid group 2, article 4, §1.c.ii	DN ≤ 200 or PN ≤ 10 or PN*DN ≤ 5000

¹⁾ The EHEDG compliance is only valid if used in combination with gaskets from Combifit International B.V.

Design and materials view

The 8098 FLOWave flowmeter consists of a S097 flow sensor and a SE98 transmitter.

The flow sensor includes the measurement tube equipped with interdigital transducers, the sensor housing and the clamp process connections in accordance to the standards ISO, ASME BPE.

At present the sensor size ranges from DN15 to DN50 or from ¾" to 2" covering a process pressure up to PN40.

The flowmeter is available as a compact device with or without display. The high resolution display with includes a capacitive working keypad for all user's interactive actions guided by a user friendly menu system.

The output signals include one analogue output and one digital output; while a third output signal can be switched between analogue and digital through parameterization. Electrical connection is done on push-in connectors via two cable glands and/or one M12 connector.

The detailed parts and materials are displayed in the following picture:

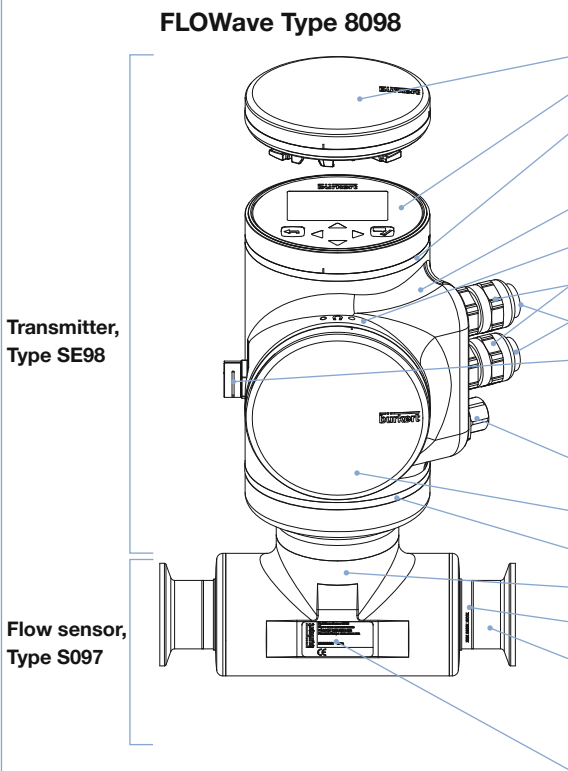
FLOWave Type 8098		Description	Material
	Blind cover or Display module		Stainless steel 304/1.4301
	Multi-colour LED behind seal (used for e.g. indicating the status of the product, based on the NAMUR NE 107 standard)		VMQ silicone
	Transmitter housing		Stainless steel 304/1.4301
	Seal		VMQ silicone
	Cable glands		Nickel plated brass
	Blind plug		Black POM
	Pressure compensating element		Diaphragm: ePTFE; support: polyester; o-Ring: silicone 60 Shore A; body: aluminium-zinc-alloy with nickel, copper sheathing
	M12 male fixed connector (wired to bus) with screwed plug		Nickel plated brass
	Blind cover		Stainless steel 304/1.4301
	Seal		VMQ silicone
	Sensor housing		Stainless steel 304/1.4301
	Sensor measurement tube		<ul style="list-style-type: none"> Stainless steel 316L/1.4435 BN2 for process connection acc. to DIN 32676 series B Stainless steel 316L/1.4435 BN2 for process connection acc. to ASME BPE (DIN 32767 series C)
	Process connection		
	Name plate		Metallized polyester

Operating principle

The technology used is based on SAW (Surface Acoustic Waves). The kind of wave propagation is similar to what happens when it comes to earthquakes in the nature.

In the case of FLOWave it is a miniaturized signal, not running on the surface of the earth but on a measurement tube. FLOWave uses so called interdigital transducers which are placed on flattened areas of the tube surface. There are at least 4 of them. Each one acts as emitter as well as receiver. Two of them (no. 1 and 4) are emitting in the forward flow direction, the others (no. 2 and 3) in the backward flow direction. The propagation time is measured from emitter to receiver. The difference between the wave propagation times in the forward and backward directions is proportional to the volume flow.

The high performance measurement is based on:

- Each emitter creates multiple receiving signals at two other receivers
- The results are based on the reception of the signals that pass through the liquid one or more times.
- Several measurements can be performed based on the collected information. Many properties of the liquid can be derived, including its velocity and information about the presence of gas bubbles or solid parts.

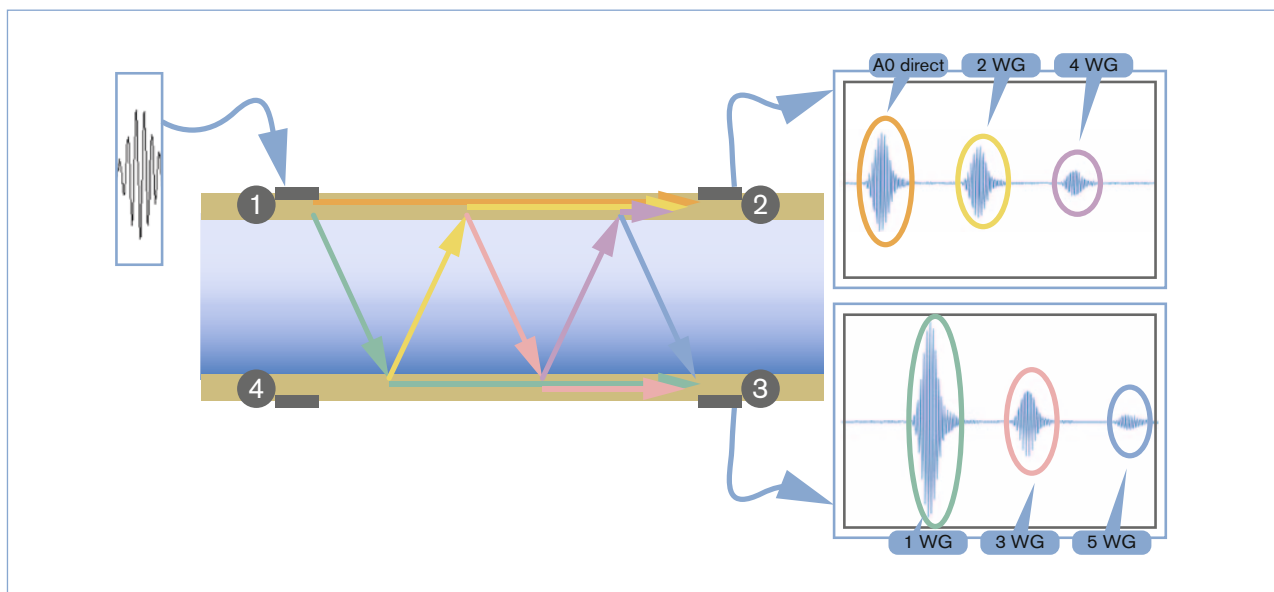

This figure indicates the receiving signals for just interdigital transducer 1 acting as emitter. The emitter excitation produces the SAW with a frequency of more than 1 MHz.

There are two effects appearing:

- A wave propagates along the surface of the tube (see orange line).
- A wave couples into the liquid (see green line) and propagates towards the other side of the tube under a certain angle. This angle depends mainly on the propagation speed on the surface and in the liquid, respectively.
- Upon reaching the opposite side of the tube, two effects take place
 - A wave couples into the tube and propagates (see green line) to receiver 3
 - A wave couples out to the liquid (see yellow line) and propagates again to the opposite side of the tube.

These effects get repeated at each reflection, resulting in all the different colour-coded signals indicated in the figure.

Installation

The product is delivered as described in position 1 in the picture below. The position of the SE98 transmitter can be changed in 90° steps. The position of the display module and the blind cover can also be changed in steps of 90° both on the top of the unit and on the front face.

For safety reasons the display module and blind cover on the top or front are locked. The display module and blind cover can be unlocked with a magnetic key which is included in the delivery of each device.

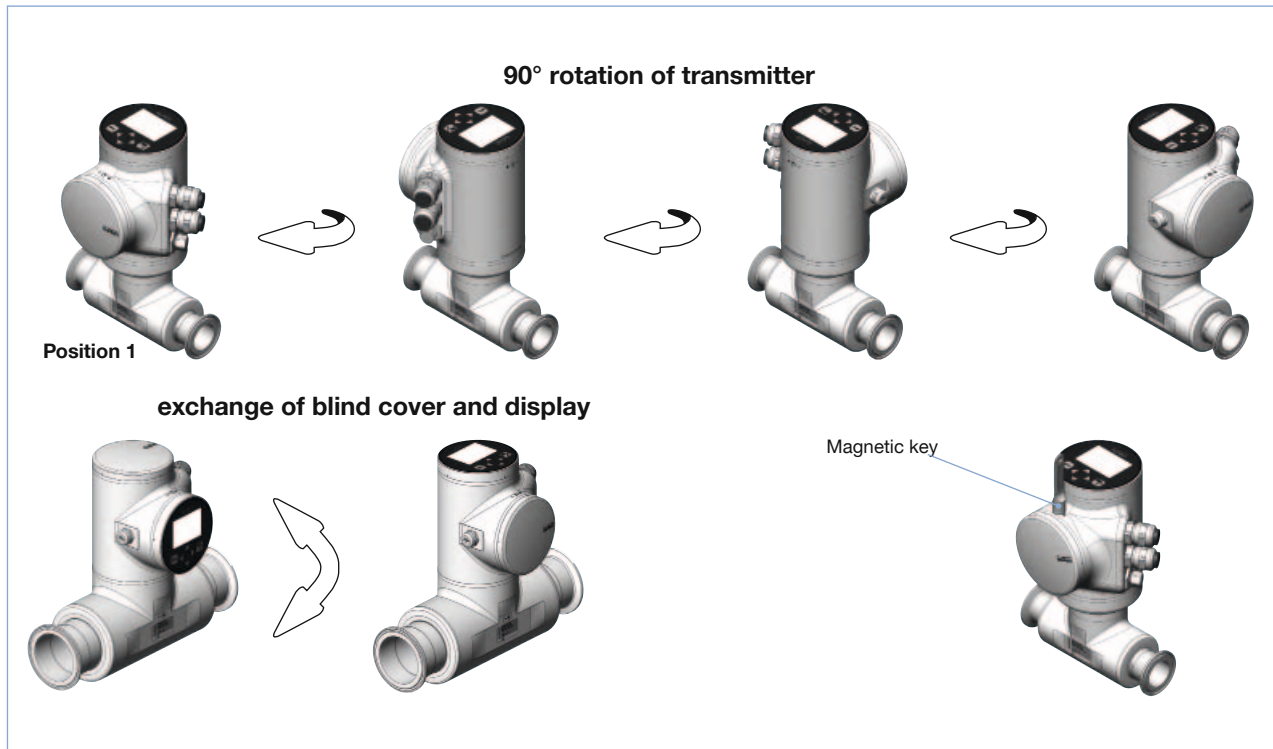

Minimum straight inlet and outlet distances must be observed. According to the pipe design, necessary distances can be bigger or use a flow conditioner to obtain the best results. The minimum inlet and outlet distances can be determined according to the standard ISO 9104.1991.

The device can be installed into either horizontal, oblique or vertical pipes. But an installation on a vertical pipe will be better to prevent air or gas bubbles inside the measurement area.

For proper operation always ensure a totally filled measurement tube.

Conformity to 3A and EHEDG requires an angle of at least 3° against horizontal to ensure complete draining however this not necessary for proper operation of FLOWave.

The suitable pipe size can be selected using the diagram flow rate/velocity/DN (see diagramm on next page).

The flowmeter is not designed for gas or steam flow measurement.

Diagram flow rate/velocity/DN

Example:

- Flow rate: 10 m³/h
 - Ideal flow velocity: 1...3 m/s
- For these specifications, the diagram indicates a pipe size of DN40

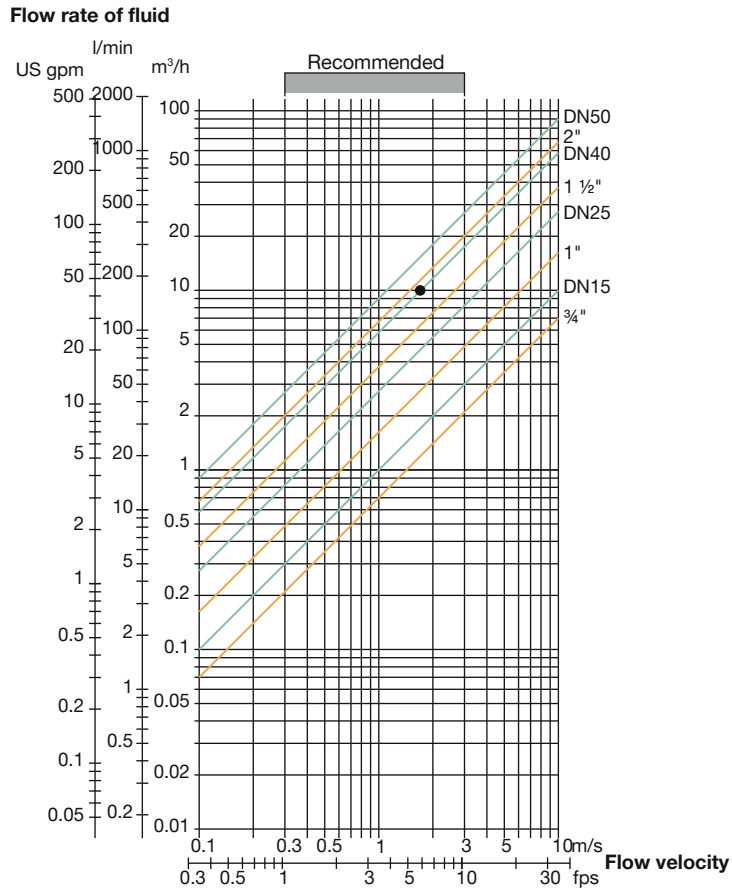

Measurement deviation per measurement area

DN	Flow velocity [m/s]	0.1	1	10
3/4"	Flow rate range [m ³ /h]	0.07	0.7	7
		< ±0.08 % of F.S.		±0.4 % of the measured value
15	Flow rate range [m ³ /h]	0.10	1.0	10
		< ±0.08 % of F.S.		±0.4 % of the measured value
1"	Flow rate range [m ³ /h]	0.14	1.4	14
		< ±0.08 % of F.S.		±0.4 % of the measured value
25	Flow rate range [m ³ /h]	0.25	2.5	25
		< ±0.08 % of F.S.		±0.4 % of the measured value
1 1/2"	Flow rate range [m ³ /h]	0.35	3.5	35
		< ±0.08 % of F.S.		±0.4 % of the measured value
40	Flow rate range [m ³ /h]	0.56	5.6	56
		< ±0.08 % of F.S.		±0.4 % of the measured value
2"	Flow rate range [m ³ /h]	0.64	6.4	64
		< ±0.08 % of F.S.		±0.4 % of the measured value
50	Flow rate range [m ³ /h]	0.90	9.0	90
		< ±0.08 % of F.S.		±0.4 % of the measured value

Dimensions [mm]

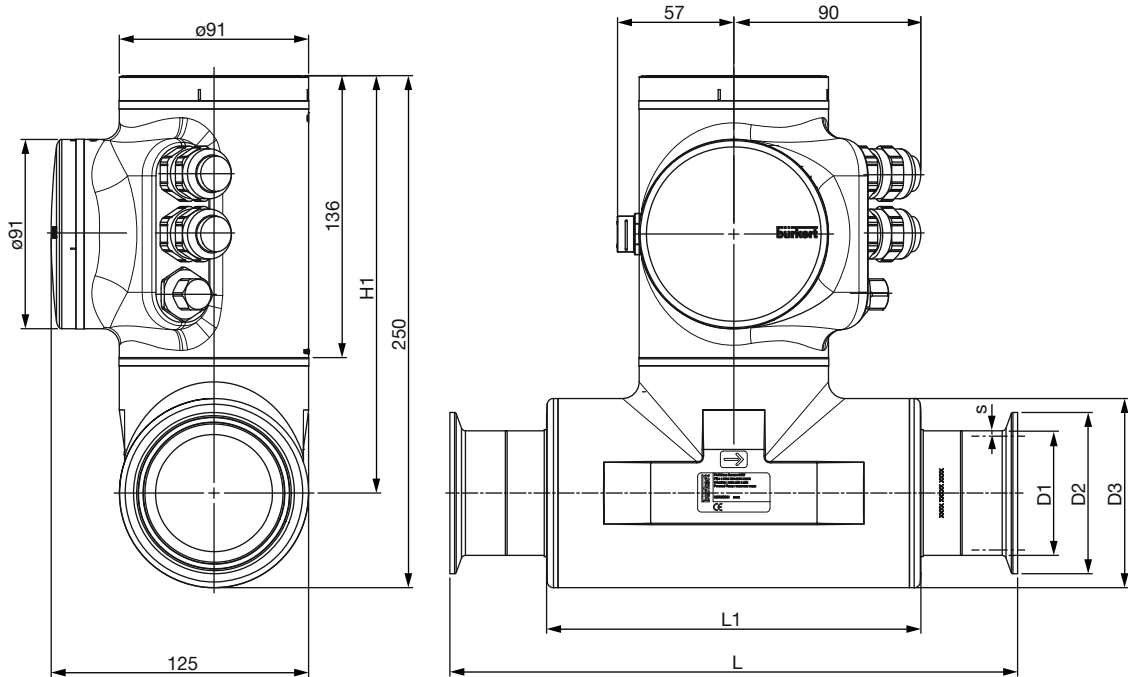

Clamp/pipe size		Standard		H1	D1	s	D2	D3	L1	L
[mm]	[inch]	Clamp	Process pipe							
15	-	DIN 32676 series B	DIN 11866 series B	220	21.30	1.60	50.5	60.3	105	168
		DIN 32676 series B*	DIN 11866 series B	220	21.30	1.60	34.0	60.3	105	168
-	3/4	ASME BPE (DIN 32676 series C)	DIN 11866 series C (ASME BPE)	220	19.05	1.65	25.0	60.3	105	143
25	-	DIN 32676 series B	DIN 11866 series B	220	33.70	2.00	50.5	60.3	120	175
		ASME BPE (DIN 32676 series C)	DIN 11866 series C (ASME BPE)	220	25.40	1.65	50.5	60.3	105	143
40	-	DIN 32676 series B	DIN 11866 series B	200	48.30	2.00	64.0	91.0	180	273
		ASME BPE (DIN 32676 series C)	DIN 11866 series C (ASME BPE)	200	38.10	1.65	50.5	91.0	180	273
50	-	DIN 32676 series B	DIN 11866 series B	200	60.30	2.00	77.5	91.0	180	273
		ASME BPE (DIN 32676 series C)	DIN 11866 series C (ASME BPE)	200	50.80	1.65	64.0	91.0	180	273

* similar to DIN 32676 series B but with clamp 34.0

Ordering chart for 8098 FLOWave flowmeter

NOTE:

To set up a device without a display, please use the USB-büS interface, Type 8920 (has to be ordered separately - see accessories on page 9)

Clamp acc. to DIN 32676 series B (ISO 1127) process connection for pipe acc. to DIN 11866 series B (ISO 1127)





Clamp/ pipe size [mm]	Meas- urement tube (outer surface), housing	Meas- urement tube (inner sur- face)	Clamp Dimensions D1 x s, D2	Operating voltage	Maxi- mal flow rate	Electrical connection	Display	Certifications		Item no.
								3A (28-04)	EHEDG ¹⁾	
15	1.6 µm	0.8 µm (30 µin.)	21.3 x 1.6 - Cl: 50.5 21.3 x 1.6 - Cl: 34.0 21.3 x 1.6 - Cl: 50.5 21.3 x 1.6 - Cl: 34.0	12...35 V DC	10 m³/h	2 cable glands M20 x 1.5 + 1 male fixed connector M12	Yes	Yes	No	566 187
							Yes	Yes	No	566 235
							No	Yes	No	566 191
							No	Yes	No	566 236
		Yes	Yes				No	566 195		
		Yes	Yes				No	566 237		
		No	Yes				No	566 199		
		No	Yes				No	566 238		
25	1.6 µm	0.8 µm (30 µin.)	33.7 x 2.0 - Cl: 50.5	12...35 V DC	25 m³/h	2 cable glands M20 x 1.5 + 1 male fixed connector M12	Yes	Yes	No	566 188
							No	Yes	No	566 192
		Yes					Yes	No	566 196	
40	1.6 µm	0.8 µm (30 µin.)	48.3 x 2.0 - Cl: 64.0	12...35 V DC	56 m³/h	2 cable glands M20 x 1.5 + 1 male fixed connector M12	Yes	Yes	No	566 189
							No	Yes	No	566 193
		Yes					Yes	No	566 197	
50	1.6 µm	0.8 µm (30 µin.)	60.3 x 2.0 - Cl: 77.5	12...35 V DC	90 m³/h	2 cable glands M20 x 1.5 + 1 male fixed connector M12	Yes	Yes	No	566 190
							No	Yes	No	566 194
		Yes					Yes	No	566 198	
		0.4 µm (15 µin.)					No	Yes	No	566 202

Clamp acc. to ASME BPE (DIN 32676 series C) process connection for pipe acc. to DIN 11866 series C (ASME BPE)

Clamp/ pipe size [inch]	Meas- urement tube (outer surface), housing	Meas- urement tube (inner sur- face)	Clamp Dimensions D1 x s, D2	Operating voltage	Maxi- mal flow rate	Electrical connection	Display	Certifications		Item no.
								3A (28-04)	EHEDG ¹⁾	
¾	1.6 µm	0.8 µm (30 µin.)	19.05 x 1.65 - Cl: 25.0	12...35 V DC	7 m³/h	2 cable glands M20 x 1.5 + 1 male fixed connector M12	Yes	Yes	Yes	566 203
							No	Yes	Yes	566 207
		Yes					Yes	Yes	566 211	
		No					Yes	Yes	566 215	
1	1.6 µm	0.8 µm (30 µin.)	25.4 x 1.65 - Cl: 50.5	12...35 V DC	14 m³/h	2 cable glands M20 x 1.5 + 1 male fixed connector M12	Yes	Yes	Yes	566 204
							No	Yes	Yes	566 208
		Yes					Yes	Yes	566 212	
		No					Yes	Yes	566 216	
1 ½	1.6 µm	0.8 µm (30 µin.)	38.1 x 1.65 - Cl: 50.5	12...35 V DC	35 m³/h	2 cable glands M20 x 1.5 + 1 male fixed connector M12	Yes	Yes	Yes	566 205
							No	Yes	Yes	566 209
		Yes					Yes	Yes	566 213	
		No					Yes	Yes	566 217	
2	1.6 µm	0.8 µm (30 µin.)	50.8 x 1.65 - Cl: 64.0	12...35 V DC	64 m³/h	2 cable glands M20 x 1.5 + 1 male fixed connector M12	Yes	Yes	Yes	566 206
							No	Yes	Yes	566 210
		Yes					Yes	Yes	566 214	
		No					Yes	Yes	566 218	

¹⁾ The EHEDG compliance is only valid if used in combination with gaskets from Combifit International B.V.

Ordering chart for accessories for Type 8098 (has to be ordered separately)

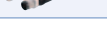
Specification	Item no.
 USB-büS-Interface (see drawing below)	772 426
 Unlocking magnetic key	690 309
 5 pin M12 female straight cable plug with plastic threaded locking ring, to be wired	917 116
 5 pin M12 female and male straight cable plug moulded on cable (1 m, shielded)	772 404
 5 pin M12 female and male straight cable plug moulded on cable (3 m, shielded)	772 405



Note
You can fill out the fields directly in the PDF file before printing out the form.

Standard configuration – request for quotation

Please fill out this form and send to your local Bürkert Sales Centre with your inquiry or order

Company	Contact person
Customer no.	Dept.
Address	Tel./Fax
Town / Postcode	E-Mail

= Mandatory fields Quantity Desired delivery date

Operating data

Process fluid	<input type="text"/>		
Type of fluid	<input checked="" type="checkbox"/> Liquids		
	min.	max.	Unit
Flow rate (Q)¹⁾	<input type="text"/>	<input type="text"/>	<input type="text"/>
Temperature	<input type="text"/>	<input type="text"/>	<input type="text"/>
Absolute pressure	<input type="text"/>	<input type="text"/>	<input type="text"/>
Viscosity	<input type="text"/>	<input type="text"/>	<input type="text"/>
Density	<input type="text"/>	<input type="text"/>	<input type="text"/>

¹⁾ Standard unit: Fluid Q = m³/h

Comments

Sketch

<hr/> <hr/> <hr/> <hr/> <hr/> <hr/> <hr/> <hr/> <hr/> <hr/>	
---	--

Certifications

- | | |
|--|---|
| <input type="checkbox"/> Test report 2.2 acc. to EN 10204 (Item no. 803 722) | <input type="checkbox"/> EHEDG - TYPE EL-CLASS I ¹⁾ |
| <input type="checkbox"/> Inspection certificate 3.1 acc. to EN 10204 (included in delivery) | <input type="checkbox"/> 3A - 28 04 (included in delivery) |
| <input type="checkbox"/> Certification of Conformity for the Surface Quality DIN 4762; EN ISO 4287; EN ISO 4288 (Item no. 804 175) | <input type="checkbox"/> Calibration certificate (included in delivery) |
| <input type="checkbox"/> Certification of Conformity for Passivating and Electropolishing Processes (Item no. 444 900) | <input type="checkbox"/> FDA certificate (included in delivery) |
| <input type="checkbox"/> Certification of compliance ASME BPE (included in delivery) | |

¹⁾The EHEDG compliance is only valid if used in combination with gaskets from Combifit International B.V.
Note: If a certification which is not included in delivery with the FLOWave is requested, please order it separately.
If you want to order one or more later, please contact your Bürkert office.

To find your nearest Bürkert facility, click on the orange box → www.burkert.com

In case of special application conditions, please consult for advice.

Subject to alteration.
© Christian Bürkert GmbH & Co. KG

1705/4_EU-en_00895282

DTS 1000270652 EN Version: D Status: RL (released | freigegeben | validé) printed: 31.05.2017