

Remote Process Actuation Control System AirLINE – PHOENIX INLINE

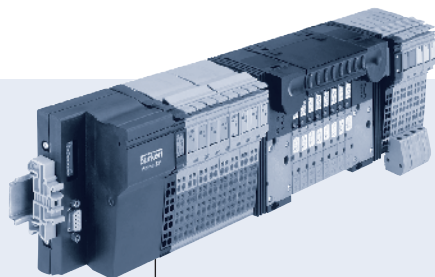

- Fully compatible with Phoenix Inline System
- Combination of Fieldbus, pilot valves and I/O modules
- High flexibility
- Compact design
- High flow rate

Type 8644 can be combined with...



Type 8175
Sensors

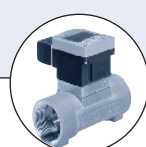

Type 8032
Switches

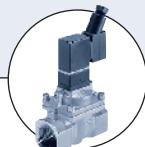

Type 6212
Solenoid valves



Type 2012
Process valves

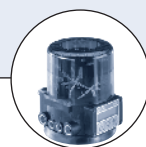

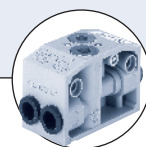

Type 8630
Valve controllers



Type 0498
Double pilot controlled check valve

The AirLINE System integrates high performance solenoid pilot valves, remote electronic I/O and fieldbus communication into a process actuation and control system that is both compact and extremely flexible. Its modular design allows fully customized, pre-mounted and tested solutions to exactly

meet all application needs including the integration of a local Mini PLC. Due to the full electronic and mechanical integration, the valve block can be added without the need of any tools or wiring.

Specifications	Pilot valve type	
	0460, 6524, 6525 	0461, 6526, 6527 
Mounting dimensions	11 mm	16.5 mm
Circuit functions/ways	C (3/2) D (3/2) H (5/2) H (5/2) impulse L (5/3) in middle position all ports closed N (5/3) in middle position all ports vented	C (3/2) D (3/2) H (5/2) H (5/2) impulse L (5/3) in middle position all ports open N (5/3) in middle position all ports vented
Flow rate	300 l/min (200 l/min for functions H impulse, L and N)	700 l/min (500 l/min for functions H impulse, L and N)
Pressure range	Vac. up to 145 PSI	Vac. up to 145 PSI
Module types	2x and 8x (optional integrated check valves and p-shut-off-valve)	2x and 4x (optional integrated check valves) Combination of 11 mm modules (3 valves) and 16.5 mm modules is possible
Max. number of modules	Depending on application	Depending on application
Max. number of valves functionalities	64 (by use of Type 0460 & Type 6524 2 x 3/2-way valve: 32)	32 (by use of Type 0461: 24)
Pneumatic intermediate supply module	necessary after 24 valve functions; with 2 x 3/2-way valve: necessary after 16 valve functions	necessary after 16 valve functions

to be continued on page 2

DTS 1000082500 EN Version: B Status: RL (released | freigegeben | validé) printed: 22.09.2017

Specifications	Pilot valve type	
	0460, 6524, 6525	0461, 6526, 6527
Fieldbus type	PROFIBUS DP, INTERBUS, DeviceNet, CANopen, Ethernet, others on request	PROFIBUS DP, INTERBUS, DeviceNet, CANopen, Ethernet, others on request
Electrical modules	PHOENIX INLINE	PHOENIX INLINE
Digital modules	2 or 4 inputs 2 or 4 outputs, others on request	2 or 4 inputs 2 or 4 outputs, others on request
Analog modules	2 or 4 inputs (0-10 V, 0-20 mA, 4-20 mA, RTD, TC) 2 outputs (0-10 V, 0-20 mA, 4-20 mA) others on request	2 or 4 inputs (0-10 V, 0-20 mA, 4-20 mA, RTD, TC) 2 outputs (0-10 V, 0-20 mA, 4-20 mA) others on request
Operating voltage	24 V/DC	24 V/DC
Permissible voltage tolerance	+20%/-15% (by use of Type 0460: ±10%)	+20%/-15% (by use of Type 0461: ±10%)
Residual ripple	1 V _{ss}	1 V _{ss}
Rated power per valve	1 W (0.5 W nominal power after 120 ms)	1 W (0.5 W nominal power after 120 ms)
Rated current per valve	43 mA (28 mA holding current after 120 ms)	86 mA (56 mA holding current after 120 ms)
Temperatures		
Operating	32°F to 131°F (0°C to +55°C) (by use of Type 0460: 32°F to 122°F (0°C to +50°C))	32°F to 131°F (0°C to +55°C) (by use of Type 0461: 32°F to 122°F (0°C to +50°C))
Storage	-4°F to 140°F (-20°C to +60°C)	-4°F to 140°F (-20°C to +60°C)
Rating	IP20 IP65 in closed field housing	IP20 IP65 in closed field housing
Approvals for hazardous areas	on request	on request

Application example

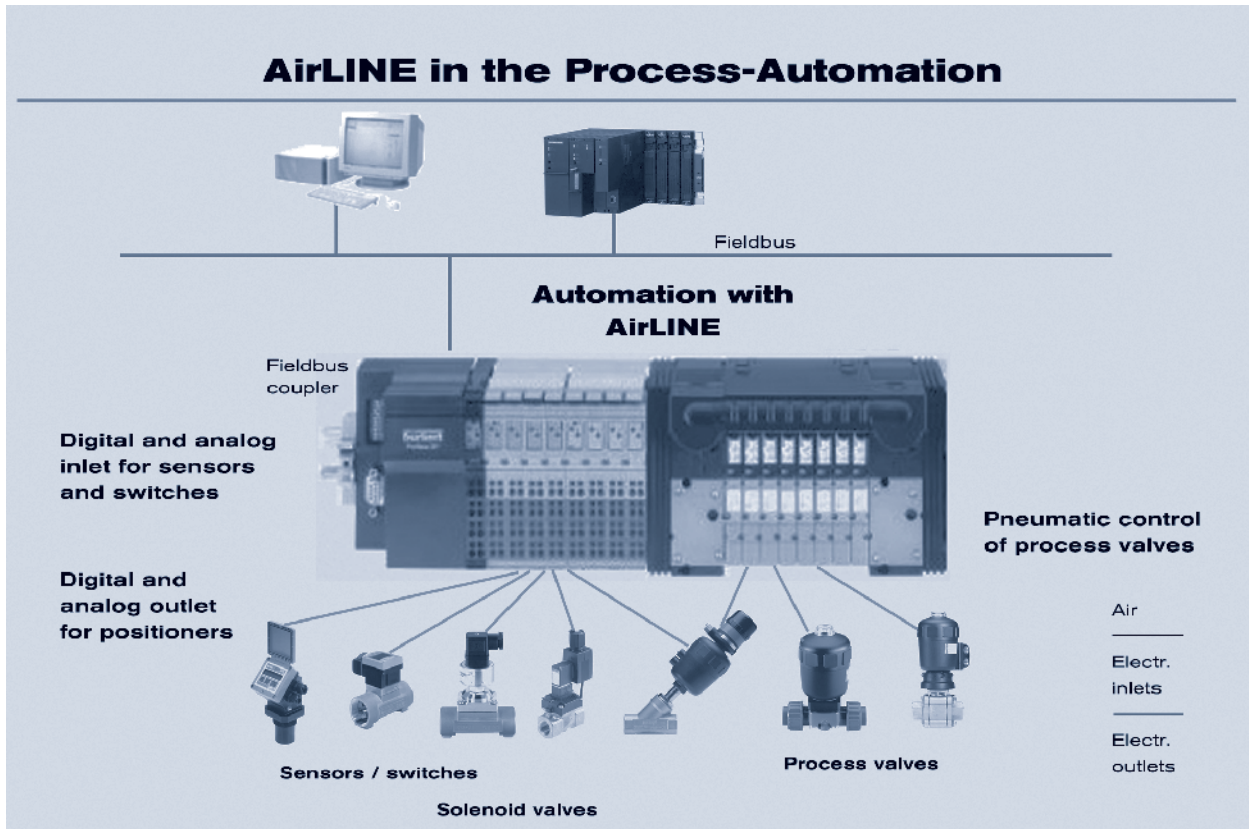

DTS 1000082500 EN Version: B Status: RL (released | freigegeben | validé) printed: 22.09.2017

Configuration software

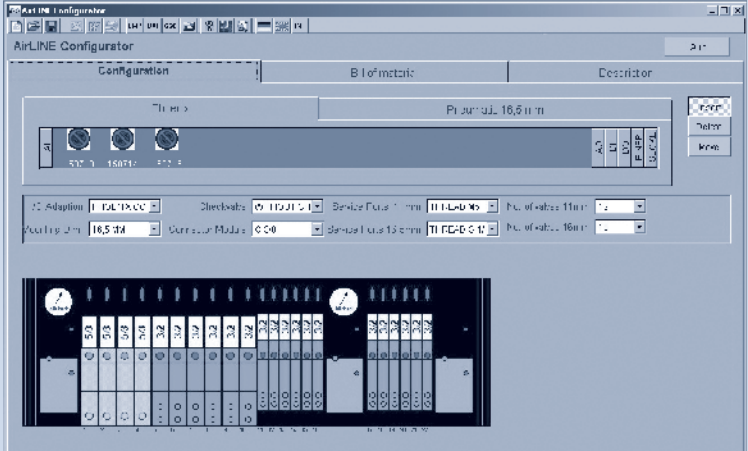

AirLine is a system of modular design which is precisely adapted to the specific requirements of the customer. Burkert offers a software program, the Configurator, for the simple, precise generation of the required configuration of each Airline system.

The Burkert Configurator defines:

- Number and types of valves
- Type of (intermediate) supplies

The results supplied by the Configurator:

- Bill of materials, incl. list prices
- Illustration

For more information consult individual datasheets, downloadable at www.burkert-usa.com

Pneumatic modules and electrical interfaces for modules PHOENIX CONTACT INLINE

Pneumatic modules MP11

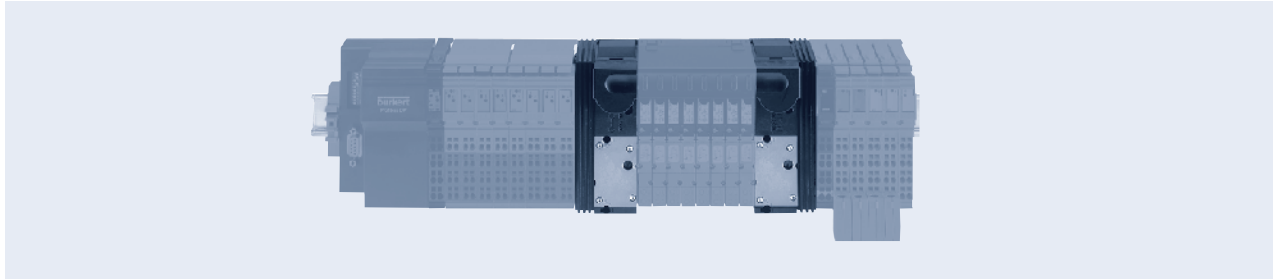

Connector module "left"

Description	Port connection	Item no.
Without pressure gauge	threaded port G 1/4	144 938
	threaded port NPT 1/4	150 236
	push-in 10 mm	150 237
With pressure gauge	threaded port G 1/4	150 235
	threaded port NPT 1/4	150 221
	push-in 10 mm	150 222

Technical data		Item no.
Measurements	bar, PSI, KPa	167 071
Pressure range	-14.5 to 145 PSI	
Media	clean + dry air, no aggressive gasses	
Port connection	G1/4	
Features	<ul style="list-style-type: none"> ▪ limit value monitoring ▪ sensitivity setting 	

Connector module "right" and Pneumatic intermediate supply module

Description	Port connection	Item no.
Connector module "right"		
Without pressure gauge	threaded port G 1/4	144 939
	threaded port NPT 1/4	150 238
	push-in 10 mm	150 239
With pressure gauge	threaded port G 1/4	150 141
	threaded port NPT 1/4	150 142
	push-in 10 mm	150 143
Pneumatic intermediate supply module		
Without pressure gauge	threaded port G 1/4	150 622
	threaded port NPT 1/4	150 624
	push-in 10 mm	150 623
With pressure gauge	threaded port G 1/4	150 625
	threaded port NPT 1/4	150 627
	push-in 10 mm	150 626

Pneumatic module and electrical interfaces for modules PHOENIX CONTACT INLINE

AirLINE valve modules

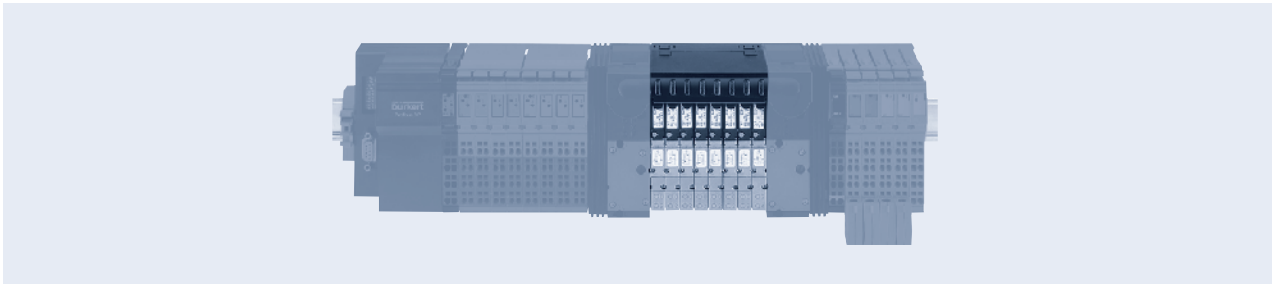

Pneumatic basic module, electrical basic module and pilot valves

2 valves wide/2 valves wide with 2 x 3/2-way valve

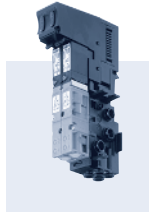

Service port 2 (A), 4 (B)

Threaded port M5
 Threaded port M7
 Push-in \varnothing 6 mm
 Push-in \varnothing 1/4"
 Push-in \varnothing 5/32"

8 valves wide/8 valves wide with 2 x 3/2-way valve

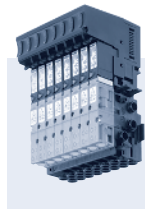

Service port 2 (A), 4 (B)

Threaded port M5
 Threaded port M7
 Push-in \varnothing 6 mm
 Push-in \varnothing 1/4"
 Push-in \varnothing 5/32"

Further pneumatic accessories

Typ 0498

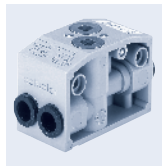

Double pilot controlled
 check Valve

Available options on request

- Check valves in R, S and P-shut
- Covering plate for spare channels
- Channel separation plugs to build different pressure areas

11mm width per station: Multi-way solenoid valve Types 6524 and 6525

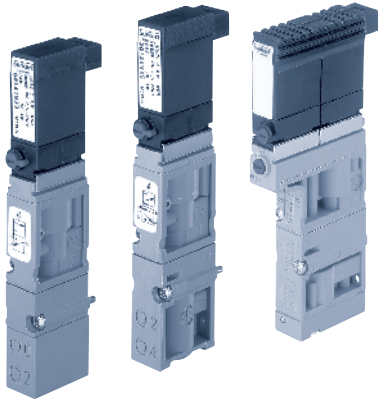

The solenoid valve Types 6524 and 6525 consist of a pneumatic valve body fitted with Type 6104 rocker pilot valve. The rocker principle allows switching of high pressure at low power consumption and fast response times. The pilot valves are equipped with manual override as a standard. The 2 x 3/2-way valve version is the combination of two pilot rocker solenoid valves type 6104 and a pneumatic seat valve.

Specification	3/2-way valve	2 x 3/2-way valve
Body material	PA (polyamide)	
Seal material	FPM, NBR	
Media	Lubricated and non-lubricated dry air, neutral gases (5 µm-Filter)	
Port connection	Flange for MP11	
Manual override	As a standard feature	
Voltage	24 V DC	
Nominal power	1 W	2 x 1 W with reduction of power consumption
Duty cycle	Continuous operation (100% ED)	
Elec. connection on valve	Rectangular plug 2-pole with raster 5.08 mm	Rectangular plug 3-pole with raster 2.54 mm
Mounting	With 2 screws M2 x 20	With 2 screws M2 x 28
Installation position	As required, preferably with pilot valve upright	
Flow rate: QNn value air [l/min]	Measured at 68°F (+20°C), 87 PSI pressure at valve inlet and 14.5 PSI pressure difference	
Pressure ranges [PSI]	Measured as overpressure to the atmospheric pressure	
Response times [ms]	Measured according to ISO 12238	

Order chart for valves

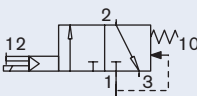
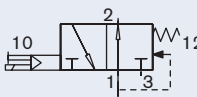
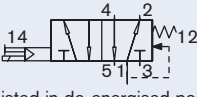
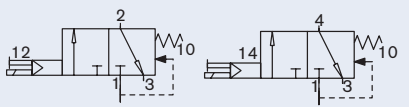
Circuit function	Orifice [mm]	C _v	Q _{Nn} -value air [l/min]	Pressure range [PSI]	Response times			item no.
					Opening [ms]	Closing [ms]	Voltage/Frequency [V/Hz]	
 3/2-way valve, servo-assisted in de-energized position port 2 to atmosphere	4	.28	300	Vac. - 101.5	15	20	24 V DC	153 958
				14.5 - 101.5 ¹⁾	15	20	24 V DC	150 333
				36.25 - 101.5	12	20	24 V DC	144 933
				36.25 - 145	15	28	24 V DC	148 227
 3/2-way valve, servo-assisted in de-energized position port 2 pressurized	4	.28	300	14.5 - 101.5 ¹⁾	12	20	24 V DC	150 334
				36.25 - 101.5	12	20	24 V DC	144 934
				36.25 - 145	15	28	24 V DC	152 139
 5/2-way valve, servo-assisted in de-energized position port 1 connected to port 2, port 4 exhausted	4	.28	300	14.5 - 101.5 ¹⁾	15	20	24 V DC	150 335
				36.25 - 101.5	15	20	24 V DC	144 935
				36.25 - 145	20	28	24 V DC	150 610
 2 x 3/2-way valve, servo-assisted in de-energized position port 2/4 to atmosphere	4	.28	300	14.5 - 101.5 ¹⁾	12	20	24 V DC	170 269 ²⁾
				36.25 - 101.5	12	20	24 V DC	170 268 ²⁾

¹⁾ Version with auxiliary air.

²⁾ Version with integrated reduction of power consumption

11 mm width per station: Multi-way solenoid valve Types 0460

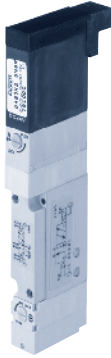

The solenoid valve Type 0460 consists of a pneumatic valve body fitted with a double coil pilot valve. The principle allows switching of high pressures together with low power consumption and fast response times. All valves are equipped with manual override as a standard.

Technical data	
Body material	Aluminium
Seal material	NBR
Media	Lubricated and non-lubricated dry air, neutral gases (5 µm-filter recommended)
Port connection	Flange
Pneumatic module	MP11
Supply port 1 (P), 3 (R), 5 (S)	G 1/4 NPT 1/4 Push-in connection Ø 10 mm
Service port 2 (A), 4 (B)	Push-in connection Ø 6 mm Push-in connection Ø 1/4" Push-in connection Ø 4 mm = ø 5/32" M5 M7
Voltage	24 V DC
Electrical connection on valve	Rectangular plug
Manual override	Standard
Flow rate: QNn-value air l/min]	Measured at 68°F (+20°C), 87 PSI pressure at valve inlet and 14.5 PSI pressure difference
Pressure ranges [PSI]	Measured as overpressure to the atmospheric pressure
Response times [ms]	Measured according to ISO 12238

Ordering chart valves

Circuit function	Orifice [mm]	C _v	Q _{0.95} -value air [l/min]	Pressure range [PSI]	Nominal power [W]	Response times		Item no.
						Opening [ms]	Closing [ms]	
H 5/2-way valve, servo-assisted impulse version	2.5	.18	200	29 - 101.5	1	15	15	154 183
L 5/3-way valve, servo-assisted in middle position all ports blocked	2.5	.18	200	29 - 101.5	1	15	20	154 184
N 5/3-way valve, servo-assisted in middle position port 2 and 4 exhausted	2.5	.18	200	29 - 101.5	1	15	20	154 185

Dimensions [mm]

5/2 way impulse and 5/3 way version, circuit function H impulse, L and N

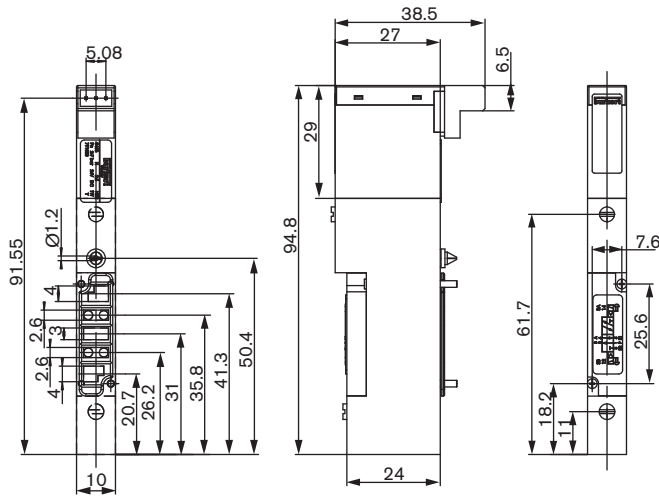

16.5mm width per station: Multi-way for solenoid valve Types 6526 and 6527

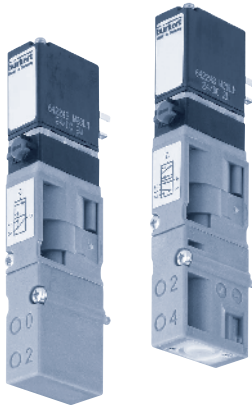

The solenoid valve Types 6526 and 6527 consist of a pneumatic valve body fitted with Type 6106 rocker pilot valve. The rocker principle allows switching of high pressure at low power consumption and fast response times. The pilot valves are equipped with manual override as a standard.

Specification	
Body material	PA (polyamide)
Seal material	NBR
Media	Lubricated and non-lubricated dry air, neutral gases (10 µm filter)
Port connection	Flange for MP12
Manual override	Standard
Voltage	24 V DC
Nominal power	2 W, 1W
Duty cycle	Continuous operation (100% ED)
Elec. Connection on valve	Tag connector acc. to DIN EN 175301-803 (previously DIN 43650) Form C
Mounting	With 2 screws M3x30
Installation position	As required, preferably with pilot valve upright

Flow rate: QNn value air [l/min]	Measured at 68°F (+20°C), 87 PSI pressure at valve inlet and 14.5 PSI pressure difference
Pressure ranges [PSI]	Measured as overpressure to the atmospheric pressure
Response times [ms]	Measured acc. to ISO 12238

Order chart for valves

Circuit functions	Orifice [mm]	C _v	Q _{Nn} -value air [l/min]	Pressure range [PSI]	Nominal power [W]	Response times			Voltage/Frequency [V/Hz]	Item no.
						Opening [ms]	Closing [ms] ³⁾			
C 3/2-way valve, servo-assisted in de-energized position port 2 to atmosphere	6	.64	700	14.5 - 145 ¹⁾	2	20	12	24 V DC	156 842	
				14.5 - 145 ¹⁾	2	20	12	24 V DC	163 028 ²⁾	
				29 - 145	2	20	12	24 V DC	156 318	
				29 - 145	2	20	12	24 V DC	158 944 ²⁾	
				29 - 116	1	20	17	24 V DC	156 840	
				29 - 116	1	20	12	24 V DC	158 947 ²⁾	
D 3/2-way valve, servo-assisted in de-energized position port 2 pressurized	6	.64	700	14.5 - 145 ¹⁾	2	12	20	24 V DC	157 672	
				14.5 - 145 ¹⁾	2	20	12	24 V DC	163 029 ²⁾	
				29 - 145	2	12	20	24 V DC	156 320	
				29 - 145	2	20	12	24 V DC	158 946 ²⁾	
				29 - 116	1	17	20	24 V DC	156 841	
				29 - 116	1	20	12	24 V DC	158 948 ²⁾	
H 5/2-way valve, servo-assisted in de-energized position port 1 connected to port 2, port 4 exhausted	6	.64	700	14.5 - 145 ¹⁾	2	20	12	24 V DC	156 828	
				14.5 - 145 ¹⁾	2	20	12	24 V DC	163 030 ²⁾	
				29 - 145	2	20	12	24 V DC	156 337	
				29 - 145	2	20	12	24 V DC	158 942 ²⁾	
				29 - 116	1	20	17	24 V DC	156 827	
				29 - 116	1	20	12	24 V DC	158 943 ²⁾	

¹⁾ version with auxiliary air

²⁾ electric connection with manual override.

³⁾ closing time approx. 5 ms higher when used together with valve unit

16.5 mm width per station: Multi-way solenoid valve Type 0461

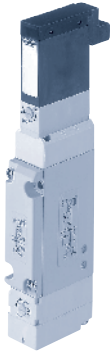

The solenoid valve Type 0461 consists of a pneumatic valve body fitted with a double coil pilot valve. The principle allows switching of high pressures together with low power consumption and fast response times. All valves are equipped with manual override as a standard.

Technical data	
Body material	Aluminium
Seal material	NBR
Media	Lubricated and non-lubricated dry air, neutral gases (10 µm-filter recommended)
Port connection	Flange
Pneumatic module	MP12
Supply port 1 (P), 3 (R), 5 (S)	G 3/8 NPT 3/8
Service port 2 (A), 4 (B)	G 1/8 NPT 1/8 Push-in connection Ø 8 mm
Operating voltage	24 V DC
Electrical connection on valve	Rectangular plug
Manual override	Standard
Flow rate: QNn-value air l/min]	Measured at 68°F (+20°C), 87 PSI pressure at valve inlet and 14.5 PSI pressure difference
Pressure ranges [PSI]	Measured as overpressure to the atmospheric pressure
Response times [ms]	Measured according to ISO 12238

Ordering chart valves

Circuit function	Orifice [mm]	C _v	Q ₉₀ -value air [l/min]	Pressure range [PSI]	Nominal power [W]	Response times		Item no.
						Opening [ms]	Closing [ms]	
H 5/2-way valve, servo-assisted impulse version	6	.46	500	36.25 - 101.5	1	20	30	156 766
L 5/3-way valve, servo-assisted in middle position all ports blocked	6	.46	500	36.25 - 101.5	1	15	50	156 767
N 5/3-way valve, servo-assisted in middle position port 2 and 4 exhausted	6	.46	500	36.25 - 101.5	1	15	50	156 768

Dimensions [mm]

5/2 way impulse and 5/3 way version, circuit function H impulse, L and N

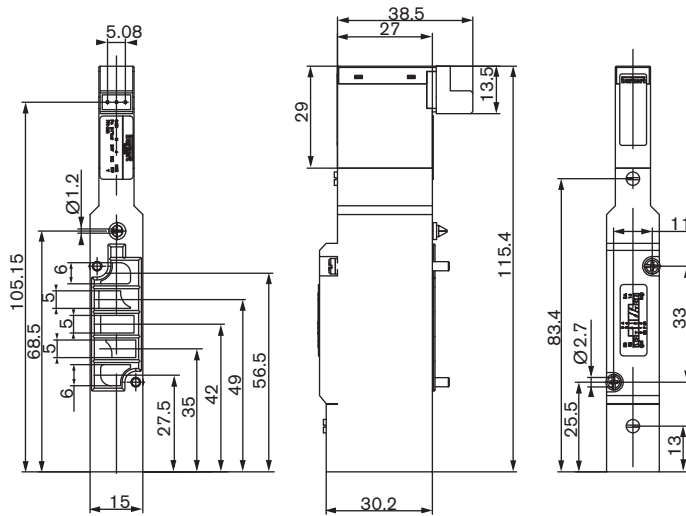

Electronic modules PHOENIX CONTACT INLINE

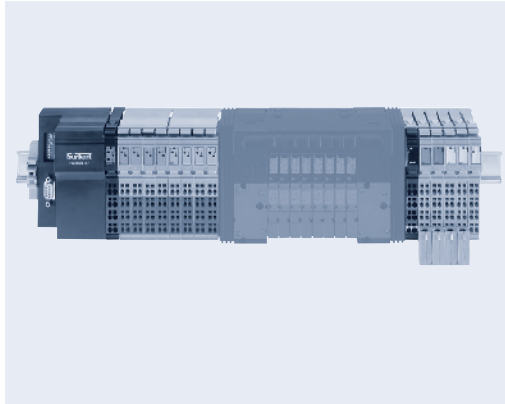

General specifications	
Voltage supply	24 V/DC (+20%/-15%)
Electrical insulation	
Logic - I/O	500 V/AC test voltage
I/O - functional ground	500 V/AC test voltage
Wire connection	Spring clamp terminals
Local diagnostics on I/O segments	
Bus active	LED green on
Comm power not present	LED green off
Comm power not present with bus inactive	LED green (flashes at 0.5 Hz)
I/O error	LED green (flashes at 2 Hz)
Previous device faulty	LED green (flashes at 4 Hz)
Dimensions (incl. connection terminal)	W x H x L
Profibus DP coupler	91 x 120 x 71.5 mm
InterBus-S coupler	48.8 x 120 x 71.5 mm
Segments (1 wide)	12.2 x 120 x 71.5 mm
(2 wide)	24.4 x 120 x 71.5 mm
(4 wide)	48.8 x 120 x 71.5 mm

Fieldbus modules (others on request)

Profibus DP/EN 51070; 12 MBaud; digital and analog signals



The Profibus DP fieldbus connects the AirLINE automation system to a Profibus DP network. The fieldbus coupler acts as a slave in the Profibus and a master in the lower level INLINE local bus.

The product is supplied with a disk containing the appropriate GSD (device master data) file for configuring the Profibus.

The INTERBUS diagnostics are supported by the Profibus DP fieldbus coupler, as are the typical diagnostics messages for the Profibus DP.

LED's facilitate accurate diagnostics at a local level.

Interface	Copper cable (RS-485), connected via SUB-B shield connector; supply electrically isolated, shielding directly connected with functional grounding
Current consumption (24 V DC supply)	
Without connected E/A terminals	< 100 mA
With max. no. of connected E/A terminals	1.25 A
Max. total perm. curr. consumption of all E/A terminals	
Logic power (7.5 V DC)	≤ 2 A
Analog supply (24 V DC)	≤ 0.5 A
Local diagnostics	
24 V main circuit supply present (UM)	LED green
24 V segment circuit supply present (US)	LED green
No communication on Profibus (BF)	LED red
Error-indication number and type (FS / FN)	LED red (2x)
Profibus data	
Number of devices per station	Max. 63
Sum of all I/O data per station	Max. 192 bytes
Max. fieldbus coupler current (for supplying the I/O module logic)	2 A at U L
Max. additional current (for supplying the analog terminals)	0.5 A at U ANA
24 V main supply U M	
Connection method	Spring clamp terminals
Recommended cable lengths	Max. 30 m (do not route cable through outdoor areas)
Safety devices	
Overvoltage	Yes
Polarity reversal	Yes
Provide an external fuse for the 24 V area	

Electronic modules PHOENIX CONTACT INLINE

DeviceNET; 125, 250 and 500 kBaud; digital and analog signals

Diagnostic LED indicators	
Network status	Indicates DeviceNET™ communication
Module status	Indicates module or inline station
Logic supply status	Indicates proper power to the local bus
Segment power (US)	Indicates proper 24 V/DC segment I/O power
Main power (UM)	Indicates proper 24 V/DC main power
Supported DeviceNET™ features	
I/O peer to peer	Yes
Explicit peer to peer messaging	Yes
Configuration consistency	Yes
Faulted node recovery	Yes
Baud rates 125K	Yes
250K	Yes
500K	Yes
I/O slave messaging	
Polled	Yes
Cyclic	Yes
Change of state	Yes
Bit strobe	Yes
24 V main supply U M	
Connection method	Spring clamp terminals
Recommended cable lengths	Max. 30 m (do not route cable through outdoor areas)
Safety devices	
Surge voltage	Yes
Polarity reversal	Yes
Provide an external fuse for the 24 V area	

The DeviceNET™ fieldbus coupler allows the AirLINE system to communicate on a DeviceNET™ network as a group 2 slave.

The coupler is housed in a 4-module width package that contains the front panel wiring and diagnostic indicators for both the local bus and DeviceNET™ communications.

Electronic modules PHOENIX CONTACT INLINE

Fieldbus modules (others on request)

InterBus-S: 500 kBaud; digital and analog signals

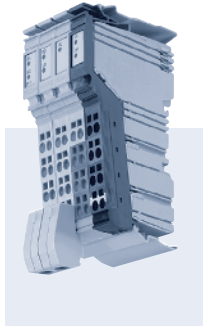

The INTERBUS terminal connects the AirLINE system with the INTERBUS network.

The bus terminal has the following functions within an AirLINE system:

- Refreshing the remote bus signals
- Decoupling the outgoing remote bus of the connected I/O modules using a software command
- Supplying the connected I/O modules using an integrated power supply unit
- Connection to functional earth when installed on the mounting rail

Interfaces	
INTERBUS remote bus (I/O)	2 x 6 pos. INLINE shield connector
Supply voltage	8 pos. INLINE input connector
INTERBUS local bus	INLINE potential distribution
Current consumption	
Without connected IB IL - I/O terminals	Approx. 100 mA
Max. total perm. curr. consumption of all I/O terminals	
Logic power (7.5 V DC)	≤2 A
Analog supply (24 V DC)	≤0.5 A
Local diagnostics	
Remote bus active (BA)	LED green
Remote bus connection OK (RC)	LED green
Outgoing remote bus disabled (RD)	LED red
Local bus branch disabled (LD)	LED red
Local bus error (E)	LED red
Communication power (UL)	LED green
Supply voltage segment circuit (SG)	LED green
Operating voltage (US)	LED green
INTERBUS data	
Max. distance from next remote bus station	400 m
Number of connectable INLINE terminals (without any additional input terminals)	63 (note permissible current consumption)
Programmable functions	
Local bus branch disabled	Yes
Local bus reset	Yes
Local bus disabled	Yes
Remote bus disabled	Yes
Remote bus reset	Yes
Local functions	
Reconfiguration input	A push button can be connected via an 8 pos. INLINE connector
General data	
Polarity reversal protection	Yes
Connector set for bus terminal	1

AS-Interface Gateway



This AS-Interface gateway allows to operate an ASi 2.1 system as a subsystem AirLINE. The configuration of ASi is done on site by means of pushbuttons directly on the gateway, or by means of parameterisation via software. The gateway has a 2-digit, 7-segment display to indicate status and diagnostics information.

As ASi master, the gateway can operate up to 62 ASi slaves according to the new specification 2.1.

Accessory modules (others on request)

Power terminal block – fused

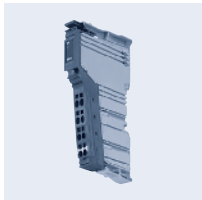

Max. nominal current	10 A
Local diagnostics Operating voltage display (US)	LED green
General data Polarity reversal protection Surge voltage protection Overload protection	Yes Yes No
Fuse (fused version)	6.3 A

Power and segment terminals provide the power supply for an Interbus station. The power terminal is used to supply the I/O circuit. The supply enables the electrical isolation of the previous isolated group.

Power terminals are available with or without integrated fuses.

Segment terminal block – fused/not fused

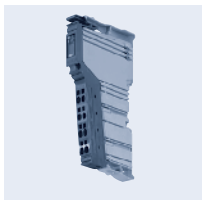

Interfaces Supply voltage INTERBUS local bus	Via voltage jumper Voltage jumper
Max. nominal current	10A
Local diagnostics Operating voltage display	Yes
General data Polarity reversal protection Surge voltage protection Overload protection	No No No

Power and segment terminals provide the power supply for an Interbus station. The power terminal is used to supply the I/O circuit.

The segment terminal can be used to group any adjacent terminals within a station into separate segments.

Segment terminals are available with or without integrated fuses.

Remote I/O modules (others on request)

Digital input module DI – 2 and 8 channel

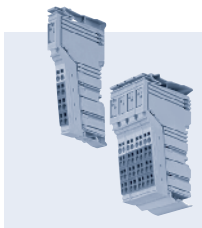

Supply Current consumption I/O voltage Residual ripple Voltage tolerance Drawing initiator supply	Approx. 30 mA (2 channel) Approx. 50 mA (8 channel) 24 V/DC (via voltage jumper) 5% 19.2 V up to 30 V/DC (ripple included) Segment circuit
Inputs Number of inputs Connection method Input current per channel Permissible range Nominal current Delay time at signal change	2 or 8 4 wire 5 mA at 24 V/DC -30 V < U _{in} < +30 V /DC "1" signal +15 V ≤ U _{in} ≤ +30 V/DC "0" signal -30 V ≤ U _{in} ≤ +5 V/DC In μs range

Digital INTERBUS INLINE input terminals are designed for the connection of digital signals such as those generated by limit switches, push buttons or proximity switches.

Remote I/O modules (others on request)

Digital output module DO – 2 and 8 channel

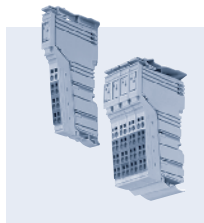

Supply	
Logic supply (via voltage jumper)	7.5 V DC
Current consumption	33 mA (2 channel) 60 mA (8 channel)
Periphery voltage	24 V DC
Ripple	5%
Voltage range	19.2 to 30 V DC
Output voltage extraction	Segment circuit
Diagnostic messages via the bus	
Short circuit, overload of an output	Yes
Inputs	
Number of outputs	2 or 8
Connection method	4 wire
Output voltage	Us - 1 V
Signal delay	In μ s range
Output current	500 mA (2- and 8 channel)
	Max. / output
	4 A (8 channel)
	Max. / terminal
	1 A (2 channel)
	12 W (2- and 8 channel)
Nominal load	Ohmic
Nominal load	Lamp
Overload protection	Yes
Short circuit protection of outputs	Yes

Digital INTERBUS INLINE output terminals are designed for the connection of digital actuators such as solenoid valves, contactors or optical indicating facility.

Analog input module AI – 2 channel; voltage and current signals

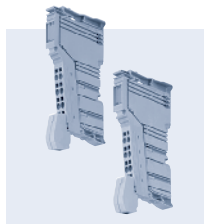

Supply	
Logic supply (via voltage jumper)	7.5 V DC
Current consumption	45 mA
Analog voltage (via voltage jumper)	24 V DC
Current consumption	12 mA
Diagnostics messages via the bus	
Overrange	Yes
Error of internal I/O voltage	Yes
Line interrupt detection	
	Yes, for the range of 4–20 mA
Inputs	
Number of inputs	2, single ended
Connection method	2-wire (shielded)
Input range	0–10 V, ± 10 V; 0–20mA, 4–20mA, 20mA
Input resistance	220 Ω (V signals); 50 Ω (mA signals);
Measurement principle	Successive approximation
Representation of measured value	16 bits two's complement
Measured value resolution	16 bits (15 bits + sign)
A/D conversion time per channel	120 μ s
Process data update	< 1.5 ms
3 dB cut-off frequency	15 Hz/ 40 Hz without averaging
Basic error limit	0.015 %

Analog INTERBUS input terminals are used for the connection of standard sensors for detecting current or voltage signals.

Terminal features include:

- High accuracy
- Fast measurement
- Very high noise and common mode suppression
- 16 bit resolution

RTD and TC inputs on request.

Remote I/O modules (others on request)

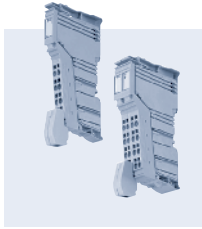

Supply	
Logic supply	7,5 V DC
Current consumption	40 mA
Analog voltage	24 V DC
Current consumption	65 mA
Outputs	
Number of outputs	1
Connection method	2 wire
Output range	0–10 V, 0–20mA, 4–20mA
Load impedance	>2 k Ω
Representation of output values	16 bit
DAC resolution	16 bit
A/D conversion time per channel	< 100 μ s
Basic error limit	0.05 %
Error type	U OUT \pm 0.5% I OUT \pm 0.8%
Transient protection of outputs	Yes

Analog output modules are used in applications which require the control of analog actuators.

Normal current and voltage output ranges can be configured individually for these terminals.

All analog signals are provided with a resolution of 16 bit.

Ordering chart fieldbus modules

Item	Description	Item no.
PROFIBUS DP	EN 51070; 12 MBaud; digital and analog signals	148 837
Interbus-S	EN 50254; digital and analog signals	150 697
DeviceNET	125-500 kBaud; digital and analog signals	on request
ASI Gateway	ASI master for up to 62 ASi slaves	on request

Ordering chart remote I/O modules

Item	Description	Item no.
DI 2 channel	24V/DC input	150 709
DI 8 channel	24 V/DC input	150 711
DO 2 channel	2.0 A	150 703
DO 8 channel	0.5 A	150 705
AI 2 channel	Thermocouple	150 714
AI 2 channel	RTD	150 715
AI 2 channel	0-20 mA, 4-20 mA, 0-1.0 V	150 713
AO 1 channel	0-10 V	150 708
AO 1 channel	0 – 20 mA, 4-20 mA, 0-10 V	150 707

Ordering chart accessory modules

Item	Description	Item no.
Power terminal block	Fused	150 699
Segment terminal block	Fused	150 701
Segment terminal block	Not fused	150 700

Pneumatic modules and electrical interfaces for modules PHOENIX INLINE

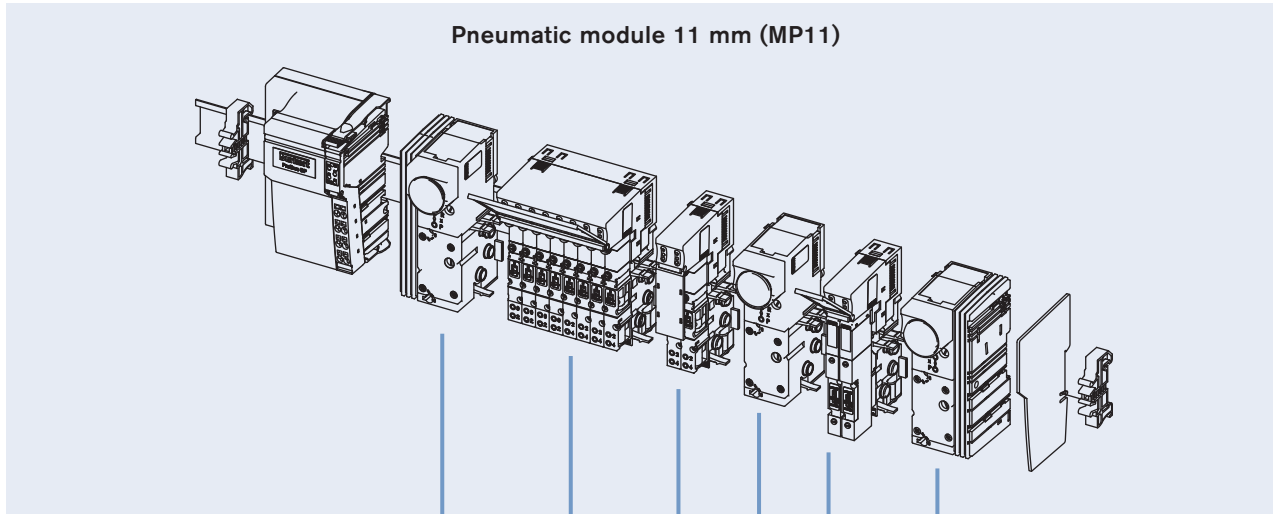

Pneumatic module 11 mm (MP11)

Connector module "left", with or without pressure gauge / digital pressure module
 Threaded port G 1/4
 Threaded port NPT 1/4
 Push-in 10 mm

Connector module "right", With or without pressure gauge
 Threaded port G 1/4
 Threaded port NPT 1/4
 Push-in 10 mm

Pneumatic basic module, electrical basic module and pilot valves
4 valves wide (pneumatic 2 x 2valves wide) (4 x 11 mm)

Pneumatic basic module, electrical basic module and pilot valves
2 valves wide (2 x 11 mm)

Service port 2 (A), 4 (B)
 Threaded port M5
 Threaded port M7
 Push-in ø 4 mm and 5/32"
 Push-in ø 6 mm
 Push-in ø 1/4"

Service port 2 (A), 4 (B)
 Threaded port M5
 Threaded port M7
 Push-in ø 4 mm and 5/32"
 Push-in ø 6 mm
 Push-in ø 1/4"

2 valves wide (2 x 11 mm)
Service port 2 (A), 4 (B)
 Threaded port M5
 Threaded port M7
 Push-in ø 4 mm and 5/32"
 Push-in ø 6 mm
 Push-in ø 1/4"

Intermediate supply module, with or without pressure gauge
 Threaded port G 1/4
 Threaded port NPT 1/4
 Push-in 10 mm

DTS 1000082500 EN Version: B Status: RL (released | freigegeben | validé) printed: 22.09.2017

Pneumatic modules and electrical interfaces for modules PHOENIX INLINE

Pneumatic module 16.5 mm (MP12)

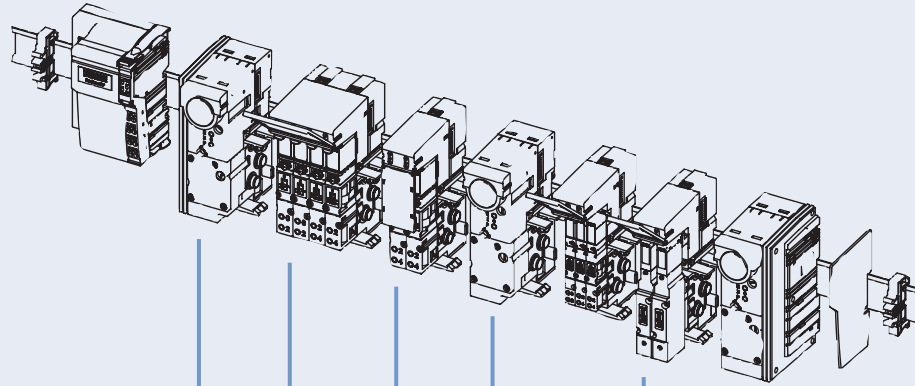

**Connector module "left",
with or without pressure gauge /
digital pressure module**

Threaded port G 3/8
Threaded port NPT 3/8

**Pneumatic basic module, electrical
basic module and pilot valves**

4 valves wide (4 x 16.5 mm)

Service port 2 (A), 4 (B)
Threaded port G 1/8
Threaded port NPT 1/8
Push-in \varnothing 8 mm and \varnothing 5/16"

2 valves wide (2 x 16.5 mm)

Service port 2 (A), 4 (B)
Threaded port G 1/8
Threaded port NPT 1/8
Push-in \varnothing 8 mm and \varnothing 5/16"

**Connector module "right",
With or without pressure gauge**

Threaded port G 3/8
Threaded port NPT 3/8

**Pneumatic basic module, electrical
Basic module and pilot valves**

3 valves wide (3 x 11 mm)

Service port 2 (A), 4 (B)
Threaded port M5
Threaded port M7
Push-in \varnothing 6 mm

**Intermediate supply module,
With or without pressure gauge**

Threaded port G 3/8
Threaded port NPT 3/8

DTS 1000082500 EN Version: B Status: RL (released | freigegeben | validé) printed: 22.09.2017

Dimensions [mm]

11 mm mounting dimensions for Type 6524 / 6525

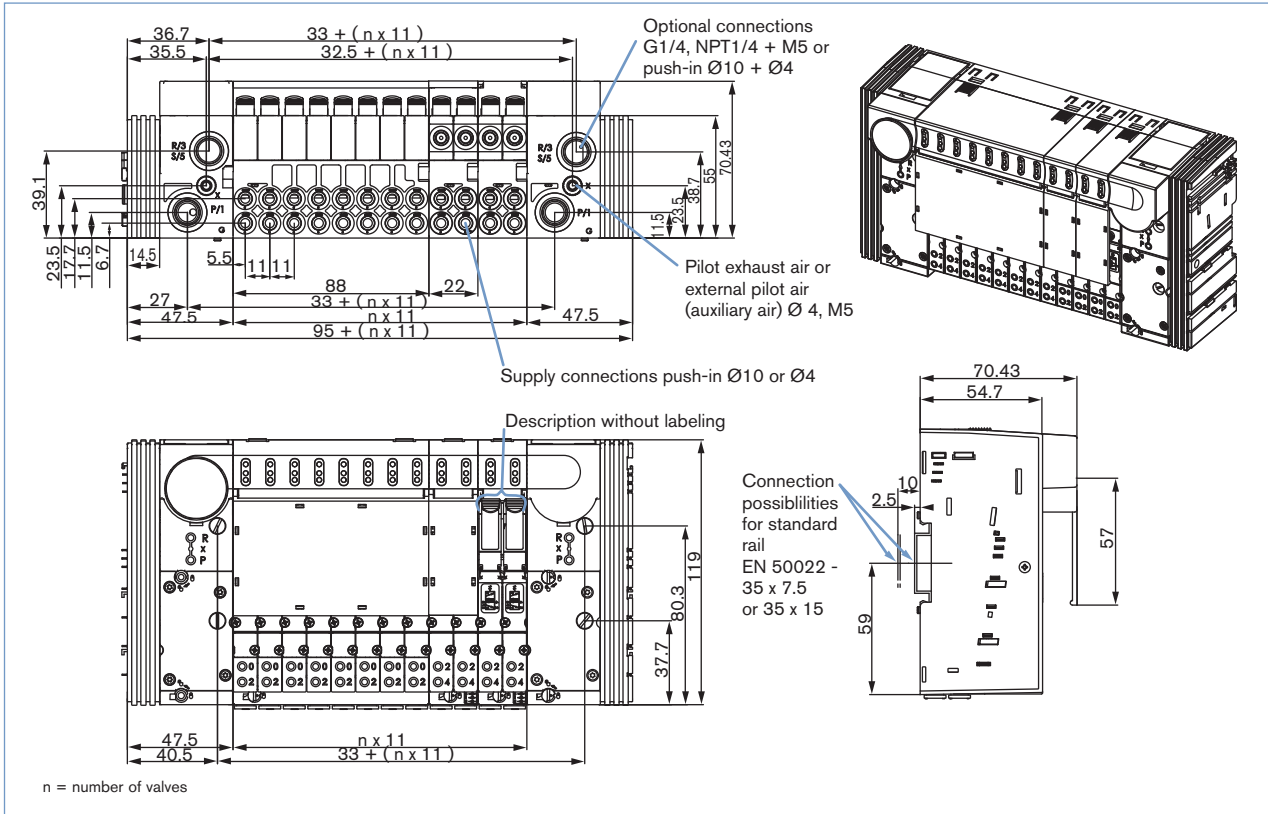

11 mm mounting dimensions for Type 6524 2 x 3/2-way valve

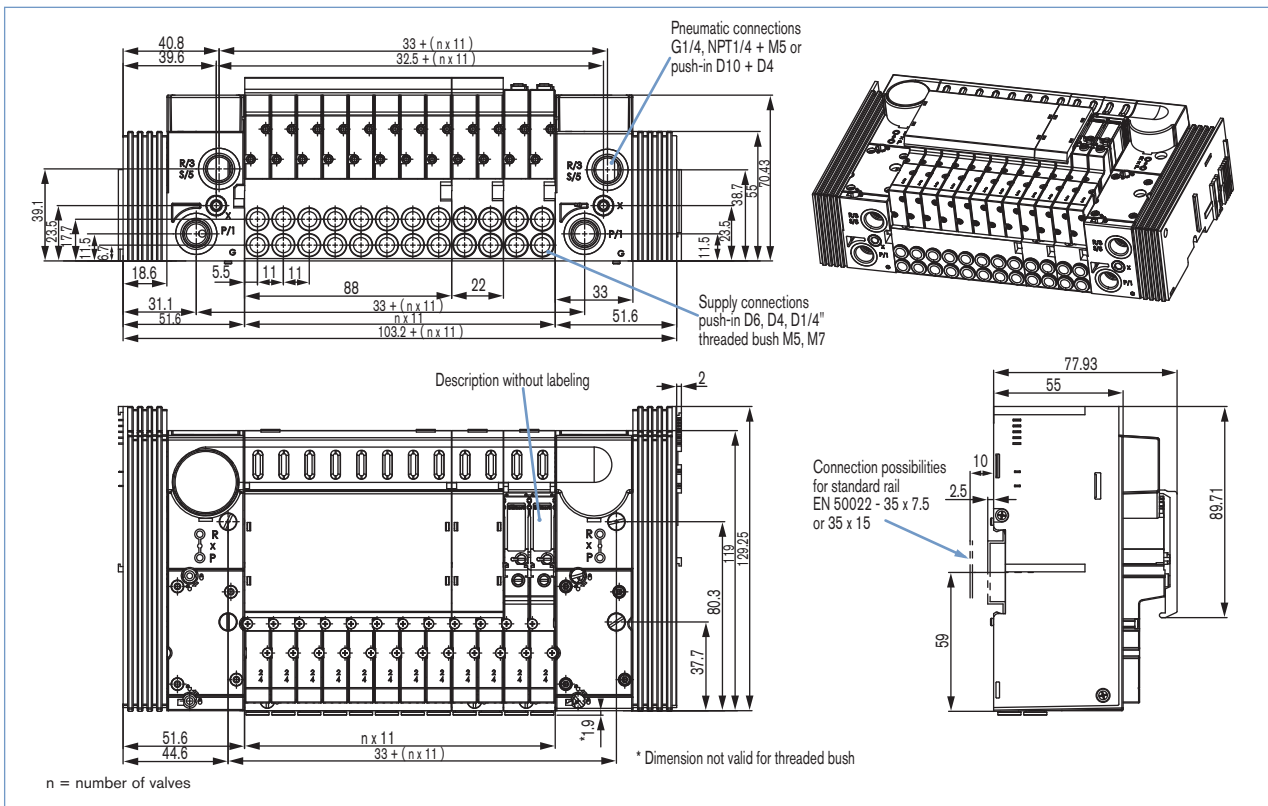

DTS 1000082500 EN Version: B Status: RL (released | freigegeben | validé) printed: 22.09.2017

Dimensions [mm]

16.5 mm mounting dimensions for Type 6526 / 6527

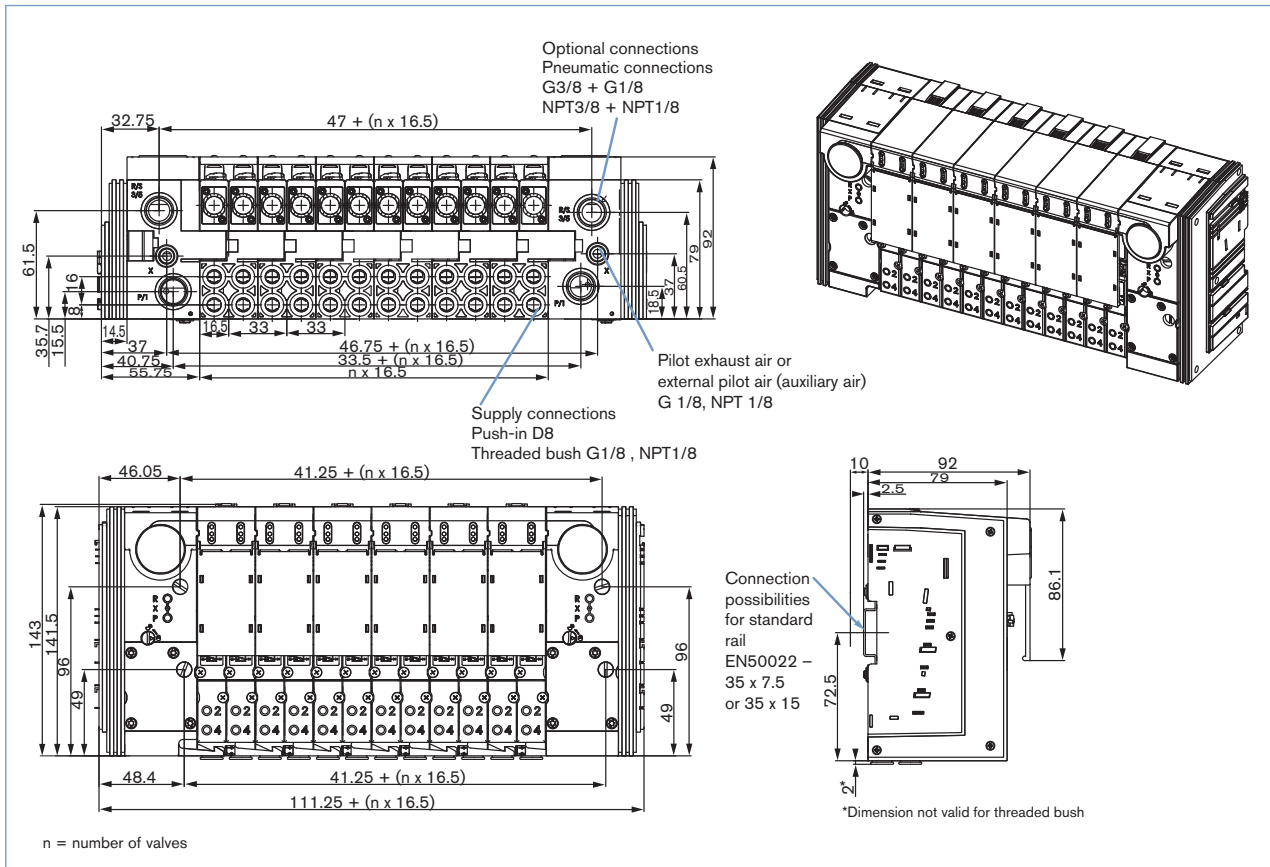

DTS 1000082500 EN Version: B Status: RL (released | freigegeben | validé) printed: 22.09.2017