

Positive displacement flowmeter



- Flow rate, 2 totalized volumes shown on display
- Automatic calibration: Teach-In
- Simulation: all output signals provided without the need for real flow

Type SE35 + S077 can be combined with...



Type 2100 (8692)
Control valve with TopControl



Type 8619
multiCELL transmitter/controller



Type 8792
Continuous SideControl

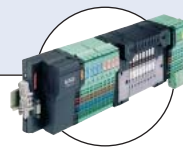

Type 8644-P AirLINE
Valve island with electronic I/O

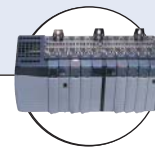

PLC

This positive displacement flowmeter with display is designed for use in highly viscous fluid like glue, honey or oil and specially to switch a valve and to establish a monitoring system or an On/Off control loop.

General data	
Compatibility	with sensor fittings S077 (see corresponding data sheet)
Materials	Housing, cover, lid, nut Front panel foil / Screws Cable glands Wetted parts materials Sensor fitting body Rotor Shaft / Seal PC Polyester / Stainless steel PA Aluminium or stainless steel (316L) PPS, aluminium or stainless steel (316L) Stainless steel (316L) / FKM or FEP/PTFE encapsulated
Display	15 x 60 mm, 8-digit LCD, alphanumeric, 15 segments, 9 mm high
Electrical connections	Cable glands M20 x 1.5
Recommended cable	max. 50 m, shielded, 1.5 mm ² max. cross-section
Complete device data (sensor fitting S077 + electronic module SE35)	
Pipe diameter	DN15...DN100
Thread connection	1/2"; 1"; 1 1/2"; 2"; 3" (G or NPT)
Flange connection	25; 40; 50; 80 or 100 mm DIN PN16 flange 1"; 1 1/2"; 2"; 3" or 4" ANSI 150LB flange
Measuring range	Viscosity > 5 mPa.s 2...1200 l/min (0.53...320 gpm) Viscosity < 5 mPa.s 3...616 l/min (0.78...320 gpm)
Medium temperature with body	in aluminium / in stainless steel -20...+80°C (-4...+176°F) / -20...+120°C (-4...248°F)
Fluid pressure max.	DN15 55 bar (798.05 PSI) (threaded process connection) DN25 / DN40 or DN50 55 bar (798.05 PSI) ¹⁾ / 18 bar (261.18 PSI) DN80 / DN100 12 bar (174.12 PSI) / 10 bar (145.1 PSI)
Viscosity	1 Pa.s max (higher on request)
Measurement deviation	±1% of Reading (if "standard" K-factor is used) ±0.5% of Reading (if "specific" K-factor is used, on label of the product)
Repeatability	±0.03% of Reading

¹⁾ or in accordance to the value of the used flanges

Electrical data	
Operating voltage	115/230 V AC 50/60 Hz (see technical specifications 115/230 V AC)
Current consumption with sensor (without consumption of pulse output)	≤ 25 mA
Output	
Signal current	4...20 mA (2-wire) max. loop impedance : 800 Ω
Pulse	Polarized, potential free, 5...36 V DC; 100 mA, protected, line drop at 100 mA: 2.5 V DC
Technical specifications 115/230 V AC	
Voltage supply available inside the device	27 V DC regulated - max. current: 125 mA integrated protection: fuse 125 mA temporised power: 3 VA
Environment	
Height above the sea	max. 2000 m
Ambient temperature	0...+50°C (32°F...122°F) (operating and storage)
Relative humidity	≤ 80%, without condensation
Standards, directives and approvals	
Protection class	IP65 with cable or screws plug mounted and tightened
Standard and directives 	
EMC	EN 61000-6-3, EN 61000-6-2
Safety	EN 61010-1
Pressure (Sensor fitting S077, DN15... DN100, in aluminium or stainless steel)	Complying with article 3 of chap. 3 from 97/23/CE directive.* (without CE mark)
Vibration	EN 60068-2-6
Shock	EN 60068-2-27

* For the 97/23/CE pressure directive, the device can only be used under following conditions (dependent on max. pressure, pipe diameter and fluid).

Type of fluid	Conditions
Fluid group 1, §1.3.a	Forbidden
Fluid group 2, §1.3.a	DN ≤ 32, or DN > 32 and PN*DN ≤ 1000
Fluid group 1, §1.3.b	PN*DN ≤ 2000
Fluid group 2, §1.3.b	DN ≤ 200

Design and principle of operation

The Flowmeter is built up with an electronic module SE35 Transmitter associated to a sensor fitting S077 with integrated measurement oval rotor. This connection is made by means of a Quarter-Turn.

The output signal are provided via two cable gland.

Quarter-Turn Technology

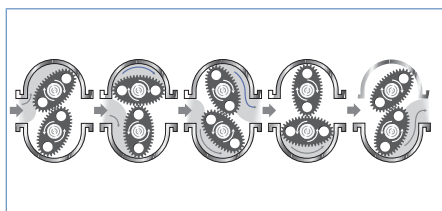
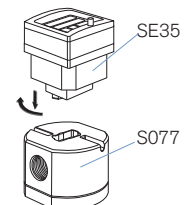

When liquid flows through the pipe, the rotors turn. This rotation produces a measuring signal in the associated hall sensor. The frequency and amplitude are proportional to the flow. The volume of the fluid being transferred in this way is exactly determined through the sensor geometry. A conversion coefficient, specific to each meter size, enables the conversion of this frequency into a flow rate. The standard K-factor depending on the meter size is available in the instruction manual of the sensor fitting S077, or to improve the measurement deviation, a specific K-factor is given with each device on its label

Installation

The sensor fitting can be installed in any orientation as long as **the rotor shafts are always in a horizontal plane** (see figures to the right).

The pipe must be filled with liquid and free from air bubbles. Avoid air purge of the system which would cause damages and to prevent damage from dirt or foreign matter, we strongly recommend the installation of a 250 µm strainer as close as possible to the inlet side of the meter.

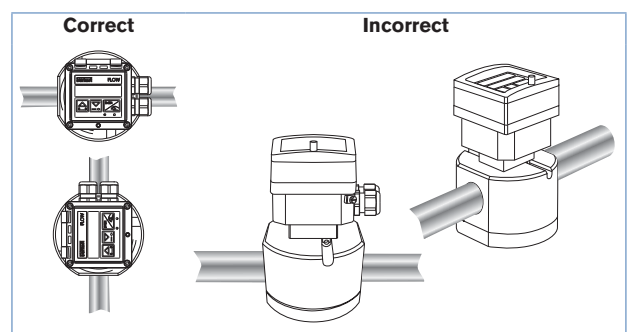

Operation and display

The device can be calibrated by means of the K-factor, or via the Teach-In function. User adjustments such as measuring range, engineering units, pulse output and filter are carried out on site.

The operation is specified according to three levels:

Indication in operating mode/display	Parameter definition	Test
<ul style="list-style-type: none"> - flow rate - output current - main totalizer - daily totalizer with reset function 	<ul style="list-style-type: none"> - language - engineering units - K-factor / Teach-In function - measuring range 4...20 mA - pulse output - filter - reset main totalizer 	<ul style="list-style-type: none"> - alteration of basic adjustment (offset, span) - frequency test of sensor - flow simulation

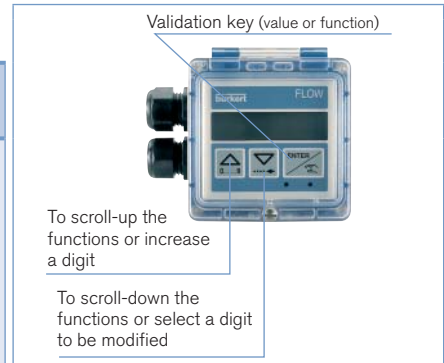

Dimensions

Electronics SE35

Orifice	H
15	126
25	135
40	147
50	157
80	207
100	223

DN15 DN25 DN40 DN50 DN80

Threaded connection

DN25 DN40 DN50 DN80 DN100

Flanged connection

Ordering information for complete flowmeter Type SE35 + S077

A complete flowmeter consists of an electronics Type SE35 and a Bürkert INLINE sensor fitting Type S077

The following information is necessary for the selection of a complete device:

- Item no. of the desired electronics **Type SE35** (see Ordering chart, below)
- Item no. of the selected INLINE sensor fitting **Type S077** (see separate data sheet- has to be ordered separately)

You have to order two components.

When you click on the orange box "More info." below, you will come to our website for the resp. product where you can download the data sheet.

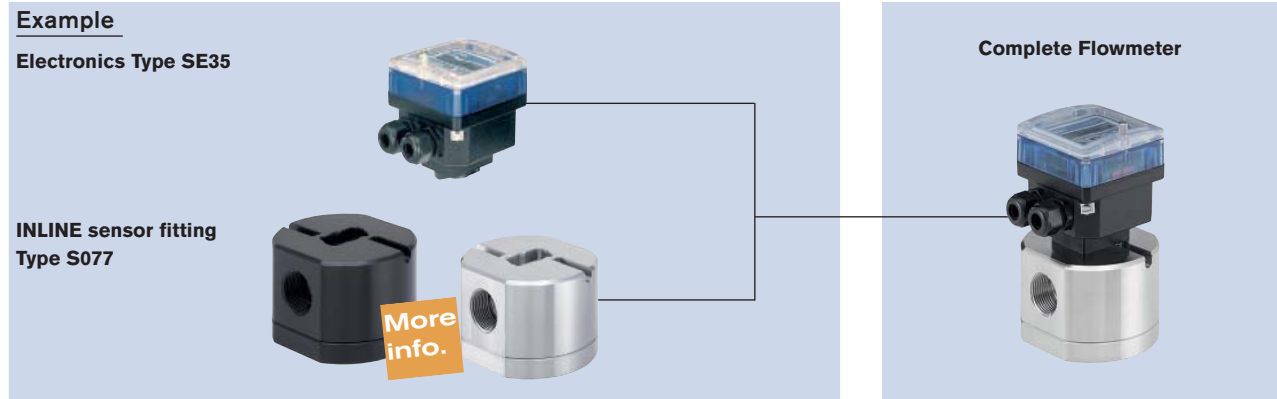

Ordering chart for electronics Type SE35

Specifications	Operating voltage	Output	Sensor version	Electrical connection	Item no.
Standard output signal flowmeter, 2 totalizers	115/230 V AC	4...20 mA (2-wire)+ pulse	Hall	2 cable glands	423 922

Ordering chart for accessories (has to be ordered separately)

Specifications	Item no.
Set with 2 cable glands M20 x 1.5 + 2 neoprene flat seals for cable gland or plug + 2 screw-plugs M20 x 1.5 + 2 multiway seals 2 x 6 mm	449 755
Set with 2 reductions M20 x 1.5 /NPT1/2" + 2 neoprene flat seals for cable gland or plug + 2 screw-plugs M20 x 1.5	551 782
Set with 1 stopper for unused cable gland M20 x 1.5 +1 multiway seal 2 x 6 mm for cable gland + 1 black EPDM seal for the sensor + 1 mounting instruction sheet	551 775

To find your nearest Bürkert office, click on the orange box →

www.burkert.com

In case of special application conditions, please consult for advice.

Subject to alteration.
 © Christian Bürkert GmbH & Co. KG

1603/0_EU-en_00895307