

CCT 01 - Set

Contamination Control Transmitter



Instruction manual

Version 2.2

Serial-no. CCT 01:

Serial-no. PFS 01:

Version valid from: 15.11.2016

Index

	Seite
1. SAFETY INFORMATION	4
1.1. Signal glossary.....	4
1.2. Dangers of maloperation	4
1.3. Intended Application.....	5
2. OPERATION AND INSTALLATION	5
2.1. Setup.....	5
2.2. Block diagram	6
2.3. General information	6
2.4. Measuring Principle	6
2.4.1. PFS 01 (Particle Flow Sensor).....	6
2.4.2. CCT 01 (Contamination Control Transmitter).....	7
2.5. Getting Ready for Operation	7
2.5.1. Sensor installation	7
2.5.2. Optimum operating conditions	7
2.5.3. Installation of the Contamination Control Transmitter.....	7
2.5.4. Electrical connection.....	7
2.6. Operation of the CCT 01	8
2.6.1. Using the Analogue Outputs	8
2.6.2. Configuration and operation using the data manager.....	9
2.6.3. Configuration and operation via virtual COM-port	24
3. CAN INTERFACE	24
3.1. Introduction to CAN and CANopen.....	24
3.1.1. CAN-Bus	24
3.1.2. CANopen.....	24
3.2. CANopen – functionality.....	25
3.3. Start-up	25
3.3.1. Baudrate.....	26
3.3.2. Node ID	26
3.3.3. Start.....	27
3.4. Object dictionary.....	27
3.4.1. Communication specific part.....	28
3.4.2. Manufacturer specific part.....	29
3.5. SDO (Service Data Object).....	30
3.6. Transmit PDO	31
3.7. Emergency Messages.....	31
3.8. Guarding.....	31
3.8.1. Nodeguarding	31
3.8.2. Heartbeat.....	32
3.9. Timestamp	32
3.10. Network Management	32
3.11. EDS-file	32
3.12. Examples for CAN-communication.....	32
4. SENSOR CALIBRATION	33

5. APPENDIX	34
5.1. Technical Data	34
5.1.1. Laser sensor PFS 01:.....	34
5.1.2. CCT 01 – Contamination Class Transmitter:.....	34
5.2. Pin Assignment	35
5.3. Assembly instructions	36
5.4. Cleanliness classes according to ISO 4406:99	37
5.5. Fields of Application - Compatibility	38
5.6. Trouble Shooting	38
5.7. Shipment	38

1. Safety information

1.1. Signal glossary

- Every nonobservance of safety instructions in this manual implies various risks and endangerment of life and the physical condition of the operator. The notices are marked with the following **signal words**:

 **DANGER** *DANGER* induces a dangerous situation which **causes dead or bad injuries** in case of nonobservance.

 **WARNING** *WARNING* induces a dangerous situation which can **cause dead or bad injuries** in case of nonobservance.

 **CAUTION** *CAUTION* induces, together with the danger symbol, a dangerous situation which can **cause light or medium heavy injuries** in case of nonobservance.

- Every nonobservance of safety instructions in this manual, which does not cause injuries but destruction of the system and its operability are marked with the following signal word:

 **NOTICE** *NOTICE* describes the correct way of handling the device.

The above signal words can be combined with the safety symbols or the warning symbols.



General danger



Danger caused by electricity







Danger for the environment

1.2. Dangers of maloperation

The CCT 01 underwent a safety inspection. The integrated electric and hydraulic safety elements ensure safe operation if the device is used as it is intended.

WARNING

In cases of maloperation or abuse, as well as in cases of ignoring the application limits and safety regulations, the following threats can occur regarding the:

- Life or physical condition of the operator; 
- The **CCT 01** device, as well as connected machines and systems; 
- The accuracy of measurements made by the **CCT 01**; 
- The environment. 

WARNING

Therefore, it is necessary that everybody having to do with the operation and the maintenance of the unit strictly follows this instruction manual!

1.3. Intended Application

The **CCT 01 – Set** is an efficient and robust inline system for the determination and transmitting of contamination classes. It consists of the contamination class transmitter CCT 01 in combination with the particle flow sensor PFS 01.

It works very reliably and does fulfill all requirements of daily measurements. Contamination can be monitored in the following:

- Different test stands for hydraulic components
- Filter service devices
- Wind energy plants
- Mobile and stationary hydraulic systems in general

Limitation of use

The device is exclusively adequate for on-line applications in hydraulic and lubricating systems within the following limitations:

Maximum acceptable operating pressure:	50 bars / 725 psi
Maximum oil temperature:	70 °C / 158 °F
Viscosity range:	10...400 mm ² /s / 46...1854 SUS
Maximum acceptable volume flow:	50 l/min / 13 gal/min

Generally, the **CCT 01 – Set** has to be operated with 24 V DC!

The regular function of the CCT 01 and the warranty of safety are guaranteed only if it is used with Eaton Technologies GmbH provided and allowed accessories.

⚠ DANGER   **No unauthorised modifications or changes are allowed at the CCT 01!**

NOTICE The terms and conditions stated in the maintenance manual have to be followed strictly!

2. Operation and Installation

2.1. Setup

The CCT 01 – Set consists of the PFS 01 (Particle Flow Sensor), a cable to connect the sensor (l = 5 m) and the CCT 01 – contamination control transmitter.



A PFS 01 belongs always to a specific CCT 01. The calibration values of the PFS 01 are stored always in the respective CCT 01!

2.2. Block diagram

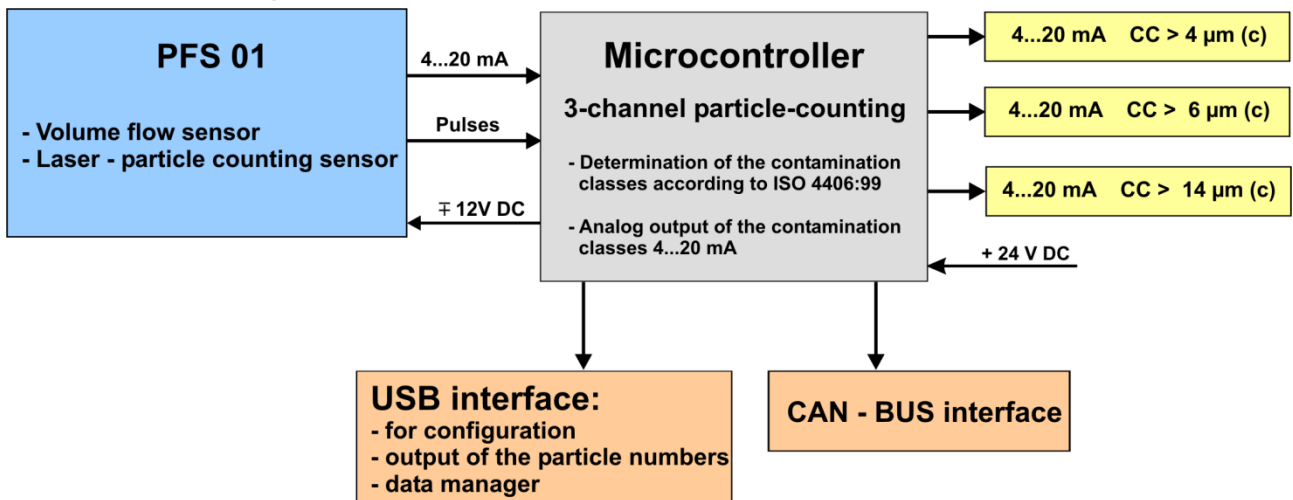

2.3. General information

The effects of contamination on hydraulic or lubrication systems are manifold. It causes significantly increased wear, increased risk of component failure as well as malfunctions.

The CCT 01 - set fulfils all necessary requirements for continuous monitoring and analysis of hydraulic systems and test stands. It is an inexpensive stationary monitoring solution.

The CCT 01 has the following functions:

- Output of the contamination classes according to ISO 4406 as current signals.
- Output of the particle numbers via USB.
- Storage of up to 1000 measurements in adjustable storage-intervals.
- Transfer of the measurement results and stored measurements on a external computer via USB interface.
- Configuration using the USB-interface.
- Controlling via CAN – bus – interface.

2.4. Measuring Principle

2.4.1. PFS 01 (Particle Flow Sensor)

- The PFS 01 consists of two sensor elements:
A laser sensor for particle counting and a flow sensor for measuring the volume flow in the measuring channel.
- The PFS 01 operates based on the offline flow principle: Using a counter balance valve, a partial flow of the oil flowing trough the device is lead through the flow sensor and laser particle counting sensor in order to analyze the oil.
- The sensor integrated in the PFS operates based on the light barrier principle, and it is calibrated with ISO MTD according to ISO 11171.

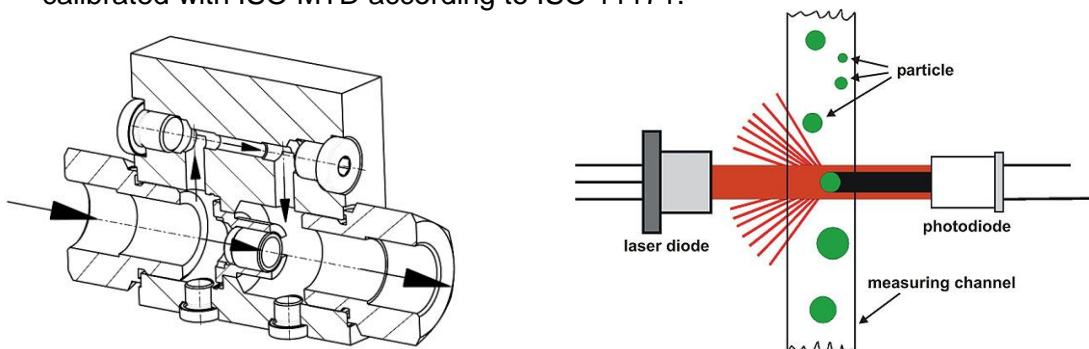

2.4.2. CCT 01 (Contamination Control Transmitter)

- The measuring signals coming from the PFS 01 are evaluated and the particles $> 4 \mu\text{m}_{(c)}$, $> 6 \mu\text{m}_{(c)}$ and $>14 \mu\text{m}_{(c)}$ are counted separately.
- Afterwards, taking into consideration the measured flow in the channel, contamination classes are determined according to ISO 4406.
- The output of the contamination classes at CON 1 takes place in three current signals (according to the diagram, respectively the table in chapter 2.6.1).
- In addition to that, particle numbers and volume flow through the measuring channel are transmitted through the USB interface (see description in chapter 2.6.2).

2.5. Getting Ready for Operation

The CCT 01 – Set should only be switched on when the PFS 01 is flown through with oil, because there is installed a thermic volume flow sensor. Very long running times without flow rate can cause damages!

2.5.1. Sensor installation

- Integrate the PFS 01 in the hydraulic system (Connection: Thread according to ISO 228-G1 or $\frac{3}{4}$ ").
- The sensor should be installed and flown through vertically if possible. Optimal, from bottom to top to avoid air inclusions respectively to dissolve them fastly.
- The assembly should be vibration-cushioned and the connection should be made with hoses.
- The installation should not be directly on vibrated components or motors.

2.5.2. Optimum operating conditions

- If there are very fine air bubbles in the oil, there is the possibility that these air bubbles are counted as particles. With a measurement under pressure (40 bar), a suppression of air bubbles is reached.
- There is another variant of the PFS 01 sensor. With this variant only the measuring channel of the sensor is flown through. For this variant a constant volume flow of 30 – 100 ml/min must be provided.
- At very low viscosities (10 – 20 mm²/s) there should be installed a more weak spring in the bypass valve and the total volume flow through the sensor should not be higher than 20 l/min.

2.5.3. Installation of the Contamination Control Transmitter

- Fastening the contamination control transmitter CCT 01 at a convenient place near the system by using the clips for the installation of the wall- and cap rail. (see chapter 5.3)

2.5.4. Electrical connection

- Connect the contamination control transmitter CCT – 01 and the laser sensor PFS 01 using the enclosed cable.

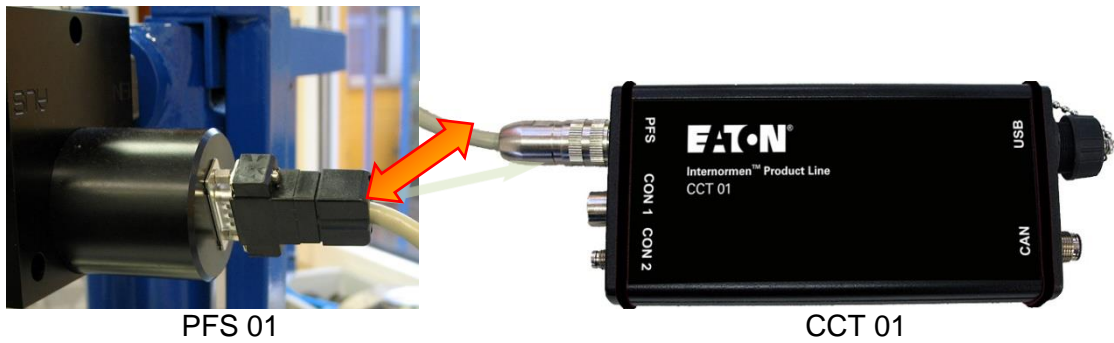

- Connect the analogue outputs of the CCT 01 (CON 1 - interface) with your evaluation system. (see chapter 5.2)



- Connect the 24 V power supply cable to the CON 2-interface of the CCT 01. Optionally the connecting over the CON 1 – interface is also possible. (see chapter 5.2)

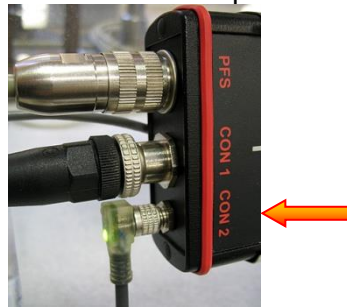

The CCT 01 is ready for operation, after the sensor has been placed into a system - considering all application limits – and after all cables are connected (sensor, power, connection to your oil system).



2.6. Operation of the CCT 01

2.6.1. Using the Analogue Outputs

- The main application of the CCT 01 is the usage of the current signal ($< 4 \mu\text{m}_{(c)}$, $< 6 \mu\text{m}_{(c)}$, $< 14 \mu\text{m}_{(c)}$) in association with an external control or analysis system. (e.g.: PLC)
- The conversion of the output-current for each measuring channel into contamination classes according to ISO 4406 can be done either with this table, with this diagram or with this formular.

CC	Nominal current [mA]	Lower current range [mA]	Upper current range [mA]
----	-------------------------	-----------------------------	-----------------------------

4	4	3.63	4.37
5	4.75	4.38	5.12
6	5.5	5.13	5.87
7	6.25	5.88	6.62
8	7	6.63	7.37
9	7.75	7.38	8.12
10	8.5	8.13	8.87
11	9.25	8.88	9.62
12	10	9.63	10.37
13	10.75	10.38	11.12
14	11.5	11.13	11.87
15	12.25	11.88	12.62
16	13	12.63	13.37
17	13.75	13.38	14.12
18	14.5	14.13	14.87
19	15.25	14.88	15.62
20	16	15.63	16.37
21	16.75	16.38	17.12
22	17.5	17.13	17.87
23	18.25	17.88	18.62
24	19	18.63	19.37
25	19.75	19.38	20.12

$$CC = \frac{\text{current}[mA] - 1}{0,75}$$

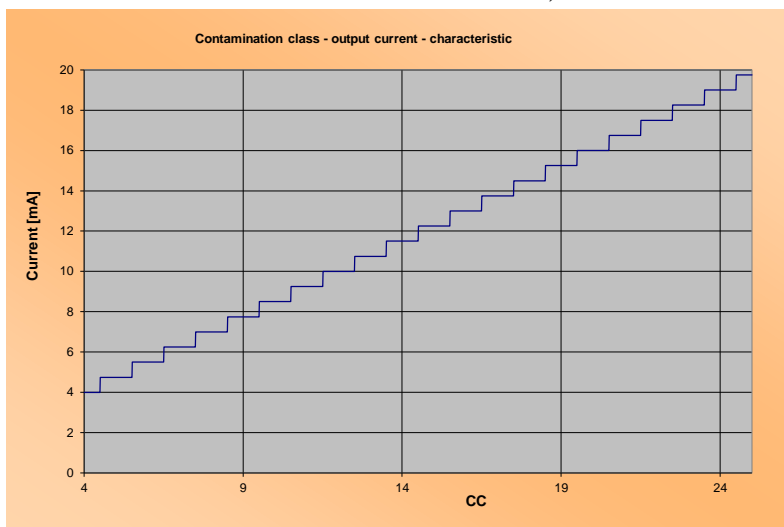

2.6.2. Configuration and operation using the data manager

The configuration and the operation of the CCT 01 using the provided data manager is the standard.

2.6.2.1. Installation of the driver

- Before connecting the CCT 01 to the computer it is necessary to install the driver from the enclosed CD-ROM.
- Using the Installation Wizard the **driver has to be installed** from the enclosed CD-ROM. (\\Driver\\Silabs USBXpress Driver\)
- Use **USBXpressinstaller_x64** for 64-Bit system or use **USBXpressinstaller_x86** for 32 Bit system.

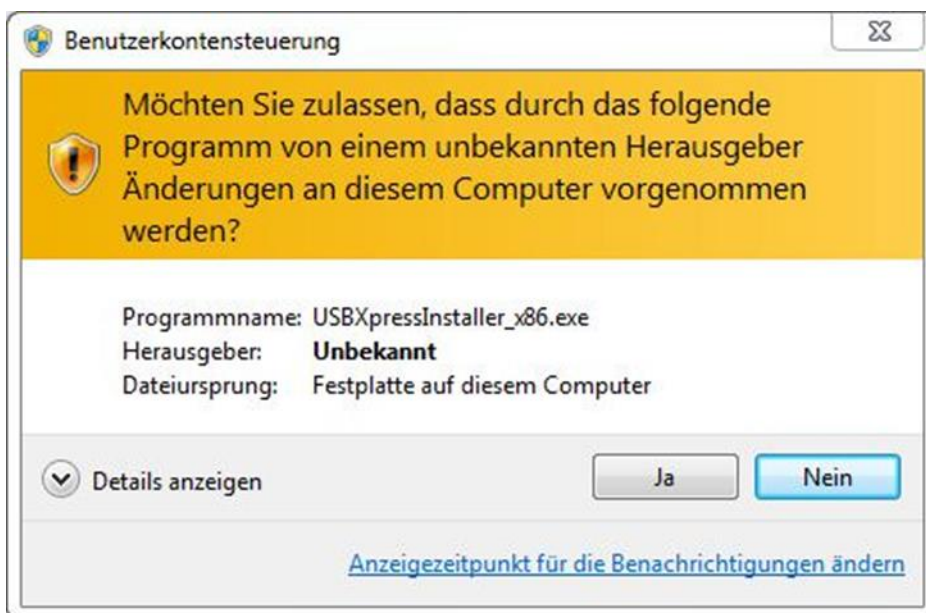



- After driver installation is complete, connect the CCT 01 to a computer using an USB- cable.



- When connecting the CCT 01 **for the first time** via USB to the computer, the **new hardware is installed**.

2.6.2.2. One-time installation of the data manager

Install the CCT 01 DATA MANAGER software Vers. 3.0 after the driver installation. The data manager software has been developed especially for the CCT 01 and is provided on the CD-ROM.

The data manager allows the configuration and operation of the CCT 01, as well as the data transfer of the stored measurement results to an EXCEL – data sheet.

Procedure of the installation:

- Start the CD-ROM „**DATA MANAGER Vers. 3.0**” and start the installation of the CCT 01- data manager program with **setup.exe**. (Confirm the security query of Microsoft Windows to get a complete installation!)
- After the successful program installation start the installed **CCT 01 Data Manager**.



2.6.2.3. Data manager

The main menu of the data manager is displayed after the initialization of the **CCT 01 Data Manager**. In the main menu the installed CCT 01 is displayed with its **serial number**.



- In the main menu clicking of the button **[DATA MANAGER]** allows the import of the data and further processing of the stored data.

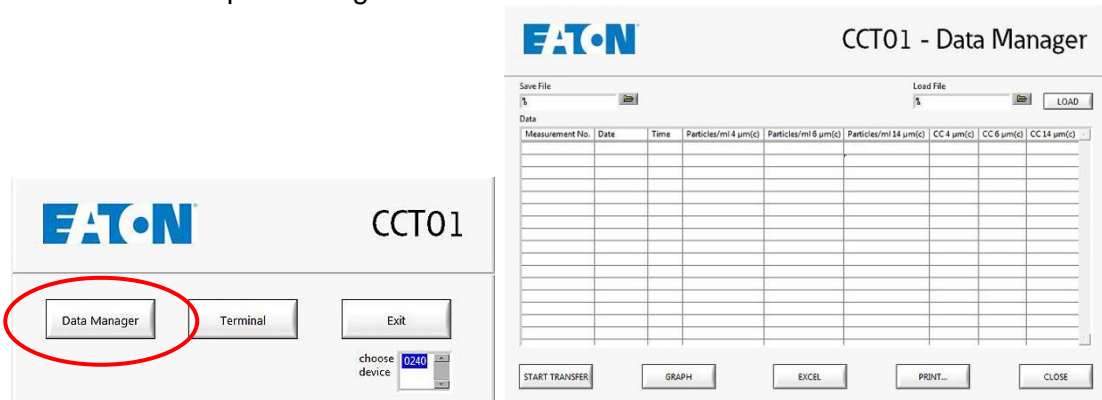

2.6.2.3.1. START TRANSFER – data transfer of the saved measurements

- Data import of the stored measurements via the button **[START TRANSFER]**.

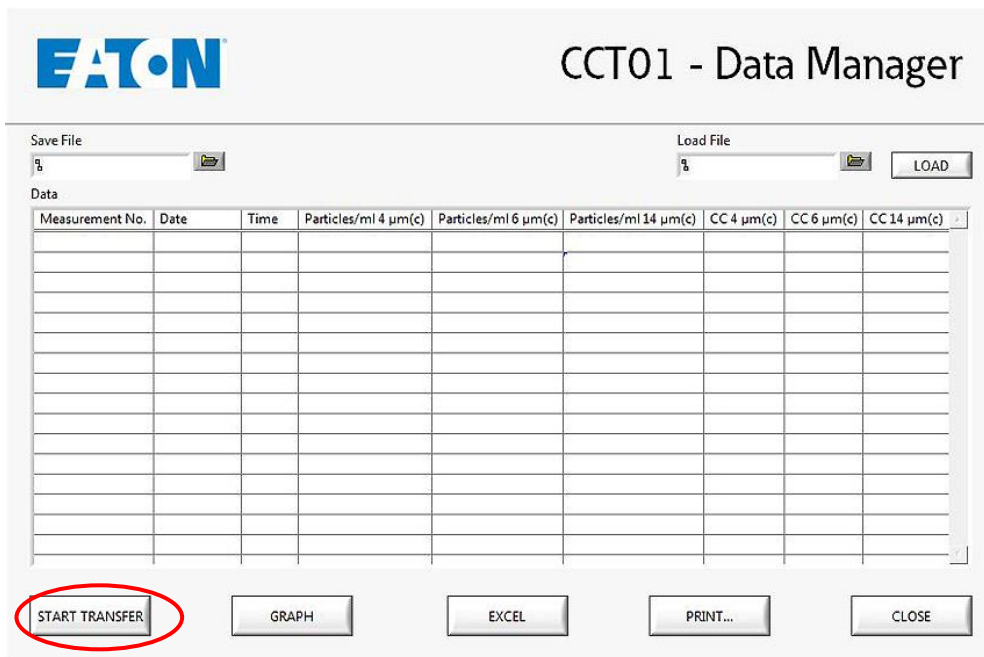

- Select path and specify filename to save the measured data.

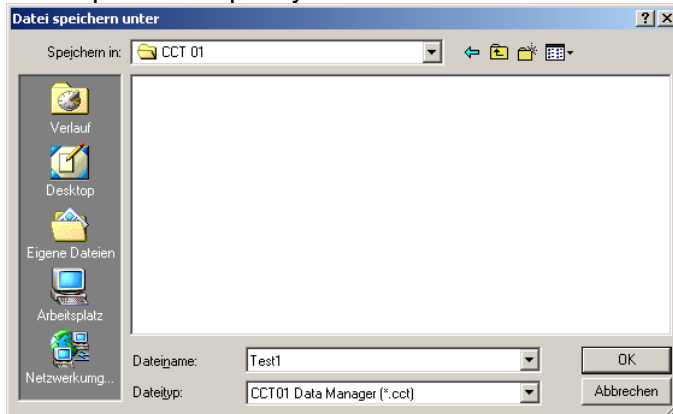

- Then the data transfers will start.

Save File

Load File

Data

Measurement No.	Date	Time	Particles/ml 4 µm(c)	Particles/ml 6 µm(c)	Particles/ml 14 µm(c)	CC 4 µm(c)	CC 6 µm(c)	CC 14 µm(c)
0001	04.03.2009	14:01	50.70	9.90	0.30	13	10	5
0002	04.03.2009	15:01	39.46	6.00	0.50	12	10	6
0003	04.03.2009	16:01	45.60	7.60	0.10	13	10	4
0004	04.03.2009	17:01	38.00	4.60	0.30	12	9	5

(a)

(b)

(c)

The transferred data can be:

- (a) diagrammed
- (b) exported to an EXCEL – data sheet
- (c) printed as a report

2.6.2.3.2. GRAPH – graphics of the transferred measurement data

- For a graphical representation of the the transferred measurement data used the button [GRAPH].
- Freely selectable the graphics of:
 - Particles per counting channel

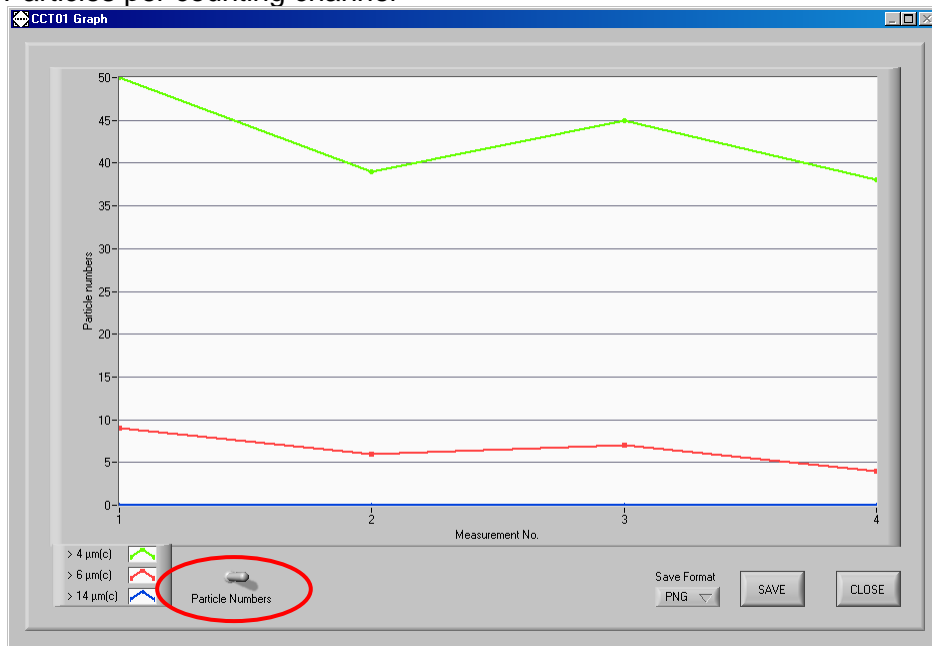

or of the

- contamination classes according to ISO 4406:99



- The graphics can be stored as PNG- or BMP – files.

2.6.2.3.3. EXCEL – export of the transferred measurement results to an EXCEL file

- Export of the transferred data to an EXCEL – data sheet via the button [EXCEL].

Measurement No.	Date	Time	Particles/ml > 4 µm(c)	Particles/ml > 6 µm(c)	Particles/ml > 14 µm(c)	CC > 4 µm(c)	CC > 6 µm(c)	CC > 14 µm(c)
1	04.03.2009	14:01	50,7	9,9	0,3	13	10	5
2	04.03.2009	15:01	39,46	6	0,5	12	10	6
3	04.03.2009	16:01	45,6	7,6	0,1	13	10	4
4	04.03.2009	17:01	38	4,6	0,3	12	9	5

- For further processing of the data all standard functions are available in EXCEL.

2.6.2.3.4. PRINT – printing a report of the transferred measured data

- Printing a report of the transferred measured data via the button [PRINT].

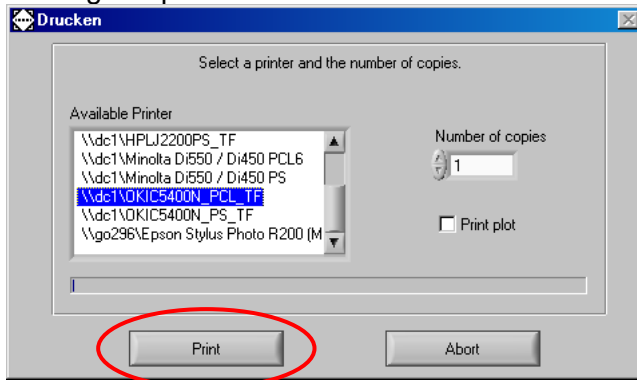

- After selecting the printer start the print-out with [PRINT].

CCT 01 Report

Eaton Technologies GmbH

Measurement No.	Date	Time	Particles/ml 4 µm(c)	Particles/ml 6 µm(c)	Particles/ml 14 µm(c)	CC 4 µm(c)	CC 6 µm(c)	CC 14 µm(c)
0001	04.03.2009	14:01	50.70	9.90	0.30	13	10	5
0002	04.03.2009	15:01	39.46	6.00	0.50	12	10	6
0003	04.03.2009	16:01	45.60	7.60	0.10	13	10	4
0004	04.03.2009	17:01	38.00	4.60	0.30	12	9	5

2.6.2.4. Closing of the data manager

- Close the data manager software via the button **[CLOSE]** and the button **[EXIT]** in the main menu.

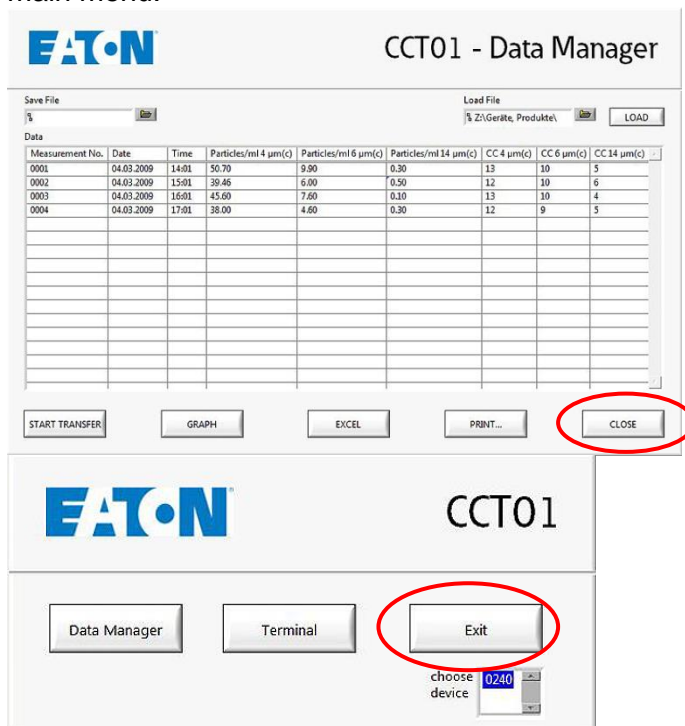

2.6.2.5. Data manager – TERMINAL

The main menu of the data manager is displayed after the initialization of the **CCT 01 Data Manager**. In the main menu the installed CCT 01 is displayed with its **serial number**.



- For the configuration and the handling of the CCT 01 via data manager use the button **[TERMINAL]** in the main menu.

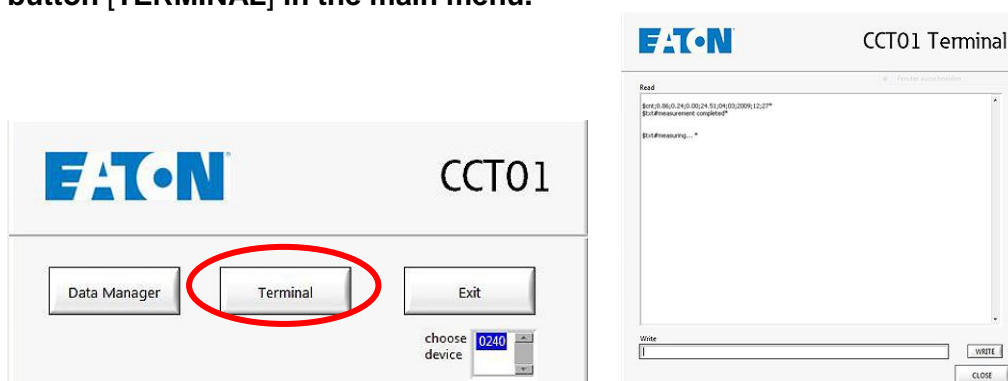

- If the measurement is running the actual results will be shown.
- Enter of command in the command line „WRITE“
 - Enter of the command „c“ and confirm by using the button **[WRITE]**.

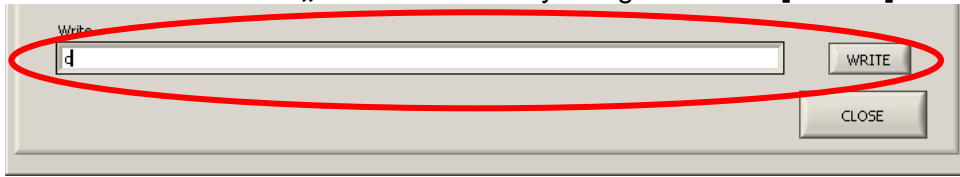

- In less than 20 seconds the command entry menu appears ⇒ after the current measurement is finished. „ENTER COMMAND“ appears on the display.



- The following commands are displayed and can be entered now:



2.6.2.5.1. Structure of the data telegrams

- Communication is done using special commands and data telegrams.
- To enter a data telegram, you always have to enter “c” first.
- In general, data telegrams are set up as follows:
\$cmd(#par#par)*

\$ Indicates the beginning of a data telegram
cmd Command
Separator

- par** Parameter of the command
- *** Indicates the end of a data telegram

- Confirm the command by using the button [WRITE].
- If the parameters should have fewer characters than provided by the wildcard-characters, leading zeros have to be entered.
For example, here is the command to set the storage interval to 24 hours:

```
$str#0024*
$      Indicates the beginning of the data telegram
str    Command: Set storage-interval
#      Separator
0024   Parameter for the command: 24 hours
*      Indicates the end of a data telegram
```

2.6.2.5.2. Input of commands

2.6.2.5.2.1. Status information

- Enter „c“ and wait for „ENTER COMMAND“:
- Enter **\$info*** in the command line and confirm by using the button [WRITE].
⇒ After few seconds the status information will be displayed.

Available Commands:

- \$info* Informations
- \$stp* stop measurement, Laser OFF
- \$run* run measurement
- \$str#xxxx* set storage interval (in hours)
- \$tme#ddmmyyyy#hhmm* set time and date
- \$del* Delete stored measurement results
- \$nid#xxx* set CAN Node-ID
- \$bdr#xxxx* set CAN baudrate (in kBit/s)
- \$can* controlling with CAN
- \$lnk* transfer stored measurement results

Enter command:

Write

\$info*

Enter command:
\$info*
Time: 11:57:45 Date: 13.03.2009
-ready for measurement-
storage interval: 1 h
no of stored measurements: 4
CAN Node-ID: 4
CAN baudrate: 125 kBit/s
\$txt#measuring... *

- After this, particle counting will be continued and results are displayed automatically.
- Entering the next function can only be done after „c“ is entered again as well.

2.6.2.5.2.2. Setting up time and date

- Enter „c“ and wait for „ENTER COMMAND“:
- Enter **\$tme#ddmmyyyy#HHMM*** and confirm by using the button [WRITE]
(dd = day mm = month yyyy = year HH = hour MM = minute)

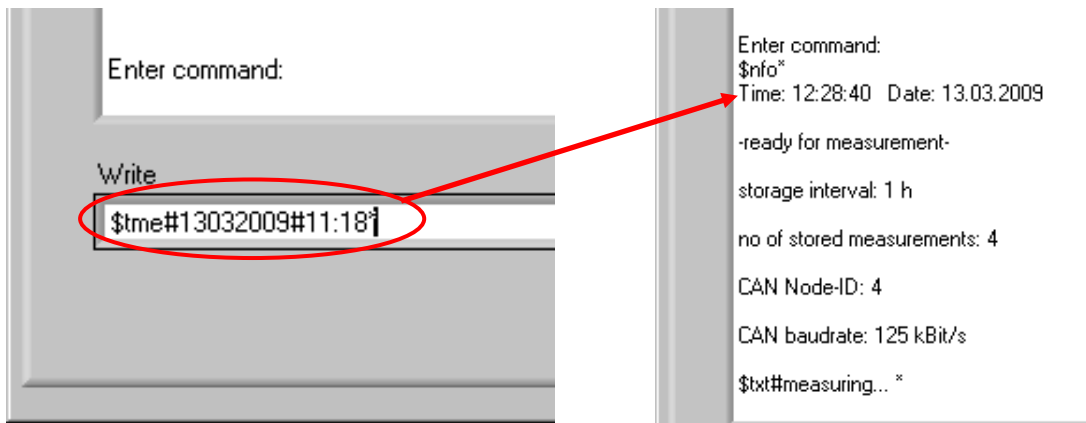

- Date and time will be stored and measurement will be continued.
Example: Entry for 13.03.2009; 11:18 h: \$tme#13032009#1118*
- Check the entry with \$nfo* ⇒ display of the set date and time.

2.6.2.5.2.3. Storage interval setup

- Enter „c“ and wait for „ENTER COMMAND“:
- Enter **\$str#xxxx*** and confirm by using the button **[WRITE]**
- Storage intervals can be entered in one hour steps and particle counting is continued automatically.

Example: \$str#0000* Measurements will not be stored.
 \$str#0001* Measurements will be stored every hour.
 \$str#0100* Measurements will be stored every 100 hours.

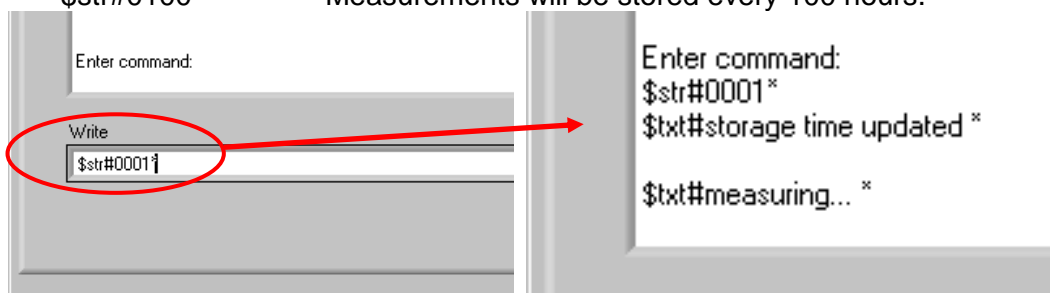

- Check the entry with \$nfo*.

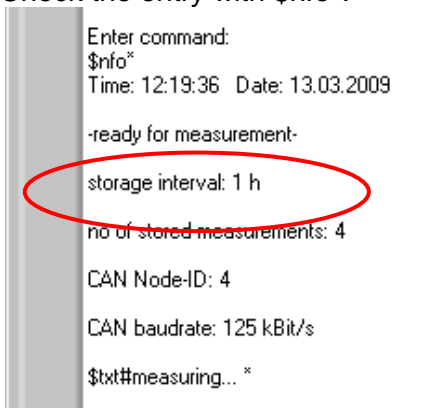

2.6.2.5.2.4. Show calibration values

- Enter „c“ and wait for „ENTER COMMAND“:
- Enter **\$scal*** and confirm by using the button **[WRITE]** .

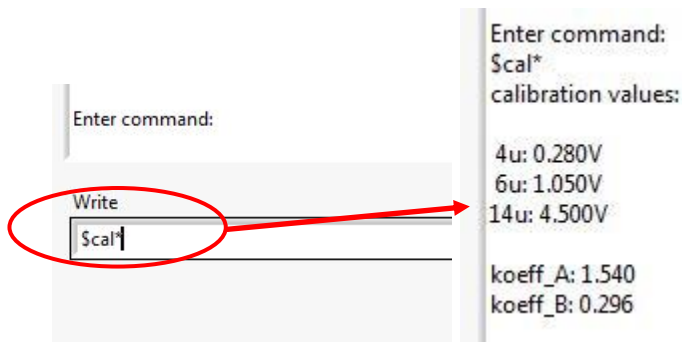

2.6.2.5.2.5. Enter calibration values

- Enter „c“ and wait for „ENTER COMMAND“:
- It must be entered 3 calibration values (4 $\mu\text{m}_{(c)}$, 6 $\mu\text{m}_{(c)}$, 14 $\mu\text{m}_{(c)}$)
- The values are in mV

Example.: \$ca1#0280* Set calibration value for 4 $\mu\text{m}_{(c)}$ to 280 mV.
 \$ca2#1050* Set calibration value for 6 $\mu\text{m}_{(c)}$ to 1050 mV.
 \$ca3#4500* Set calibration value for 14 $\mu\text{m}_{(c)}$ to 4500 mV.

The calibration values can be taken from the provided calibration certificate.

Calibration values :						noise signal:		
	4 $\mu\text{m}_{(c)}$	4,6 $\mu\text{m}_{(c)}$ 2 μm	6 $\mu\text{m}_{(c)}$	6,4 $\mu\text{m}_{(c)}$ 5 μm	10 $\mu\text{m}_{(c)}$	14 $\mu\text{m}_{(c)}$ 15 μm	21 $\mu\text{m}_{(c)}$ 25 μm	37 $\mu\text{m}_{(c)}$ 50 μm
Master sensor (particle)	67866	42563	17588	13588	2386	533	102	22
Test sensor (particle)	68107	41974	17818	13824	2396	542	99	25
admissible variation	$\leq 2\%$	$\leq 2\%$	$\leq 2\%$	$\leq 2\%$	$\leq 2\%$	$\leq 2\%$	*	*
Test sensor threshold values (mV)	250	450	1050	1190	2680	4500	6950	9950

2.6.2.5.2.6. Stop measurement

- Enter „c“ and wait for „ENTER COMMAND“:
- Enter **\$stp*** and confirm by using the button **[WRITE]**

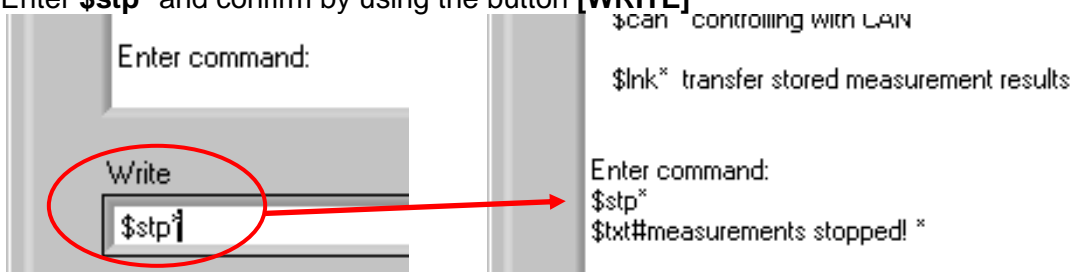

- Measurements remain stopped until it is restarted with **\$run*** (same after cutting of the operating power)

2.6.2.5.2.7. Start measurements

- Enter „c“ and wait for „ENTER COMMAND“:

- Enter **\$run*** and confirm by using the button **[WRITE]**



- Normally, the system measures automatically; starting is only necessary after a Stop-command.

Display the actual measurements:

Measurements are displayed in the following way:

\$cnt;a.aa:b.bb;c.cc;f.ff;dd;mm;yyyy;HH;MM*

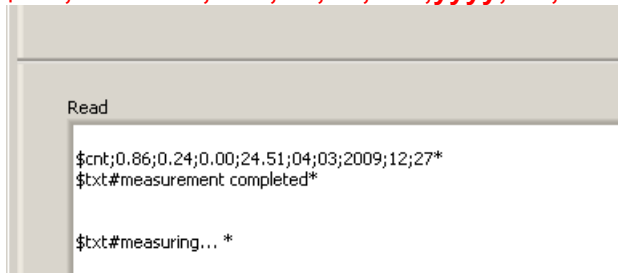

Thereby means:

- \$cnt:** Marks the beginning of a new data field (cnt = COUNT)
- a.aa:** Particles in 1 ml ($\geq 4 \mu\text{m}$)
- b.bb:** Particles in 1 ml ($\geq 6 \mu\text{m}$)
- c.cc:** Particles in 1 ml ($\geq 14 \mu\text{m}$)
- f.ff:** Volume flow through the measuring channel of the sensor in ml/ min.
- dd:** Day (Date)
- mm:** Month (Date)
- yyyy:** Year (Date)
- HH:** Hour (Time)
- MM:** Minute (Time)
- *:** Indicates the end of the data field.

2.6.2.5.2.8. Data transfer

- Using „\$lnk*“, saved measurements can be transferred from the CCT 01 to an external computer.
- Enter „c“ and wait for „ENTER COMMAND“:
- Enter \$lnk* and confirm by using the button [WRITE]

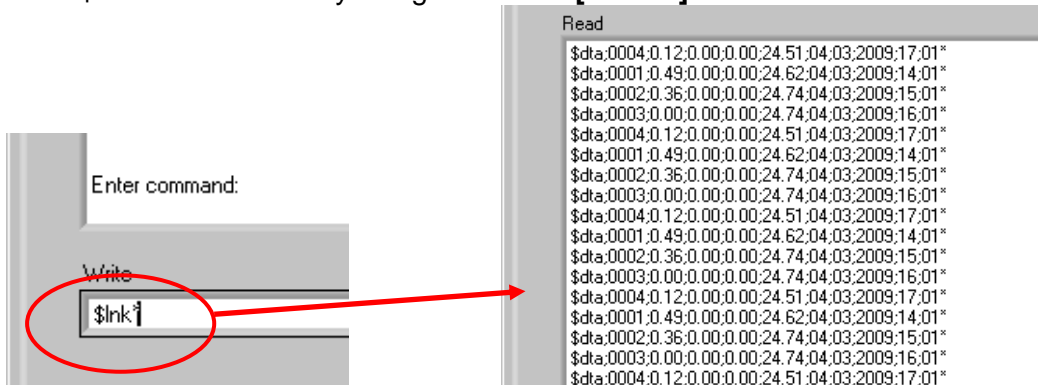

- Saved data will be transferred to the computer and directly displayed in the menu window.

Display measurements:

\$dta;xxxx;a.aa;b.bb;c.cc;f.ff;dd;mm;yyyy;HH;MM*

Thereby means:

- \$dta:** Marks the beginning of a new data field (dta = DATA)
- xxxx:** measurement number
- a.aa:** Particles in 1 ml (≥ 4 μm)
- b.bb:** Particles in 1 ml (≥ 6 μm)
- c.cc:** Particles in 1 ml (≥ 14 μm)
- f.ff:** Volume flow through the measuring channel of the sensor in ml/min
- dd:** Day (Date)
- mm:** Month (Date)
- yyyy:** Year (Date)
- HH:** Hour (Time)
- MM:** Minute (Time)
- *:** Indicates the end of the data field.

2.6.2.5.2.9. Delete stored measurements

- Enter „c“ and wait for „ENTER COMMAND“:
- Enter \$del* and confirm by using the button [WRITE]
- Stored measurements will be deleted.



2.6.2.5.2.10. CAN

The CAN – functions were detailed described in chapter 3 CAN - interface.

2.6.2.5.3. Close Terminal

- Close „Terminal“ by using the button **[CLOSE]** ⇒ back to the main menu of the data manager program.

2.6.3. Configuration and operation via virtual COM-port

- Optional it is possible to configure and operate the CCT 01 by a virtual COM-port using a separate control or analysis system. (e.g. to connect it to a PLC)
- Concerning this other drivers and settings of the CCT 01 are necessary.
In this case please direct towards to Eaton Technologies GmbH.

3. CAN interface

The CCT01 has additionally a CAN interface. The physical CAN interface complies with the Norm ISO 11898 and is electrically isolated with optocouplers. With this interface all settings which can be made with Hyper Terminal are also practicable. The communication protocol is compatible to CANopen, but there is no support to all specified CANopen-functions. In this chapter there is a small introduction to the fieldbus system CAN and the higher layer protocol CANopen and a description of controlling the CCT01 via CAN.

3.1. Introduction to CAN and CANopen

3.1.1. CAN-Bus

CAN-Bus is an asynchronous, serial fieldbus system. Primarily it was developed by “Bosch” in 1983 for the automotive industry to make networking of control units in cars easier. Because of capability to control also larger systems, CAN-Bus became an industrial standard.

CAN-Bus is based on a data exchange with an identification of the transmitted message. This is called the identifier. It has a length of 11 bit and it also determines the priority of the message. The smaller the identifier the higher the priority. The message which follows the identifier can contain up to 8 byte data. The setup of one CAN telegramme is to be seen in the next illustration.

Identifier	Byte1	Byte2	Byte3	Byte4	Byte5	Byte6	Byte7	Byte8
------------	-------	-------	-------	-------	-------	-------	-------	-------

Therefore CAN defines only the data transmission but not the meaning of a message. This is specified by the higher layer protocol CANopen.

3.1.2. CANopen

CANopen is a standard of the CAN-in-Automation. The general functionality is described in the specification DS-301.

The central element of the CANopen standard is the object dictionary. It is the interface between the network and the application. It contains general informations about the device, all measured values and parameter. The objects or parameters are addressed with a 16-bit index and an 8-bit subindex. The build-up of the object dictionary and the access to it, is described in the following chapters. CANopen defines different objects for communication. These are:

- Service Data Object (SDO): For parameter settings
- Process Data Object (PDO): For transmitting process data
- Network Management Object (NMT): For changing the state of a device
- Emergency Object: For transmitting error and alarm messages
- Timestamp Object: For adjusting the time

The differentiation of these communication objects results from the identifier. The identifier is separated in two parts. The most significant 4 bit describe the function code which declares the type of the message, the remaining 7 bit describe the Node ID. This separated identifier is called the Communication Object Identifier (COB-ID). Therefore it is possible in this broadcast system to communicate with single participants.

Functions code				Node ID						
Bit10	Bit9	Bit8	Bit7	Bit6	Bit5	Bit4	Bit3	Bit2	Bit1	Bit0

The meaning of the function code is arranged in the so-called Pre-defined connection set.

Object	Function code (binary)	Resulting COB-ID (dec)
NMT	0000	0
SYNC	0001	128
EMCY	0001	129 - 255
PDO1 (tx)	0011	385 – 511
PDO1 (rx)	0100	513 – 639
PDO2 (tx)	0101	641 – 767
PDO2 (rx)	0110	769 – 895
PDO3 (tx)	0111	897 – 1023
PDO3 (rx)	1000	1025 - 1151
PDO4 (tx)	1001	1153 – 1279
PDO4 (rx)	1010	1281 – 1407
SDO (tx)	1011	1409 – 1535
SDO (rx)	1100	1537 – 1663
NMT Error Control	1110	1793 - 1919

3.2. CANopen – functionality

The CCT01 does not have the complete CANopen – functionality. The following functions of CANopen are available:

- Object dictionary with all measured data and parameters
- One SDO-Server → For parameter settings
- One transmit PDO → For transmitting the measured data
- Nodeguarding or Heartbeat
- Emergency object for error or alarm messages
- Timestamp for adjustment of time
- NMT-State-Machine

3.3. Start-up

For starting the controlling with CAN you must proceed as follows.

3.3.1. Baudrate

- Start the data manager and activate the „**CCT 01 TERMINAL**“ with the button [TERMINAL] in the main menu.
- Enter „**c**“ in the command line, confirm with the button [WRITE] and wait for „**Enter command**“.

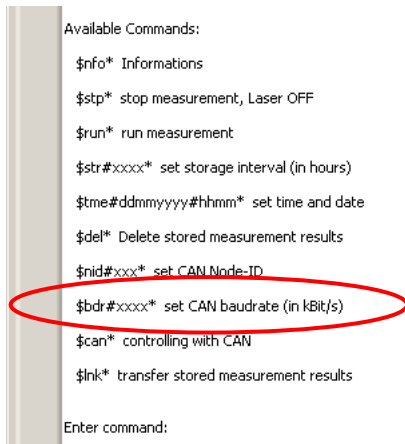

- Input of the baudrate with the command **\$bdr#xxxx*** and confirm with [WRITE].
- Baudrate is set in kBit/s.
- Redundante digits are filled with 0.
- The following baudrates are supported:
 - 20 kBit/s
 - 50 kBit/s
 - 125 kBit/s
 - 250 kBit/s
 - 500 kBit/s
 - 800 kBit/s
 - 1 MBit/s

Examples: \$bdr#0050* Baudrate 50 kBit/s
 \$bdr#0125* Baudrate 125 kBit/s
 \$bdr#1000* Baudrate 1 MBit/s (1000 kBit/s)

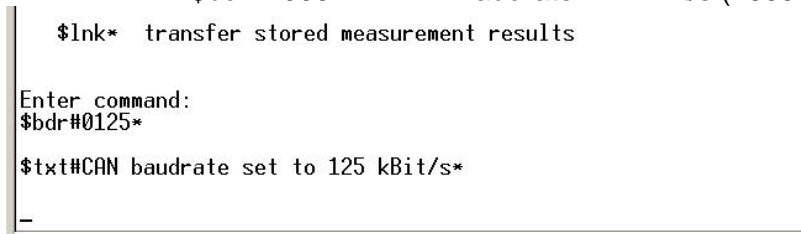

The default value of the baudrate is 125 kBit/s.

3.3.2. Node ID

- Enter „**c**“ in the command line, confirm with [WRITE] and wait for „**ENTER COMMAND**“:
- Enter: **\$nid#xxx*** and confirm with [WRITE].
- Redundante digits are filled with 0.

- The value of the node ID can be between 1 and 127.

Examples: \$nid#100* Node ID 100
 \$nid#051* Node ID 51

```
Enter command:
$nid#050*

$txt#Node-ID set to 50*
```

The default value of the node ID is 1.

3.3.3. Start

- Enter „c“ in the command line, confirm with **[WRITE]** and wait for „ENTER COMMAND“:
- Enter: **\$can*** and confirm with **[WRITE]**.
- Now there is the initialisation phase, followed from the Bootup – message. After this message the NMT – state “**Pre-Operational**” is achieved. The Bootup – message has the following buildup.

Identifier	Daten
700h + Node ID	00h

- The actual NMT – state is also displayed via the USB interface.

```
Enter command:
$can*

$txt#Controlling with CAN!*

$txt#state: Initialisation*

$txt#state: pre-Operational*
```

- To stop controlling via CAN enter “c”.
- You must enter “c” again to get to the main menu.
- If the device is switched off during the CAN-mode it will start automatically in the CAN-mode at the next reset.

3.4. Object dictionary

- The object dictionary has a buildup like a table with lines and columns.
- An entry of the object dictionary is addressed with an index and a subindex.
- The object dictionary of the CCM01 is subdivided into two parts (communication specific part and manufacturer specific part).
- All parameters and measured values are accessible via the standard-SDO with an index and a subindex.
- In the following chapters the two parts of the object dictionary are described with the index, subindex, data type, access and default value.

3.4.1. Communication specific part

Index (hex)	Subindex (hex)	Description	Data type	Access	Default value
1000	0	Device Type	UNS32	ro	12Dh
1001	0	Error Register	UNS8	ro	0
1002	0	Manufacturer Status Register	UNS32	ro	0
100C	0	Guard Time	UNS16	ro	0
100D	0	Life Time Factor	UNS8	ro	0
1010	Store Parameter Field				
	0	Number of Entries	UNS8	ro	1
	1	Save all Parameters	UNS32	ro	1
1012	0	COB-ID Time Stamp Object	UNS32	rw	100h
1014	0	COB-ID Emergency Object	UNS32	ro	80h + NID
1017	0	Producer Heartbeat Time	UNS16	rw	0
1200	Server SDO Parameter				
	0	Number of Entries	UNS8	ro	2
	1	COB-ID Client Server	UNS32	ro	600h + NID
	2	COB-ID Server-Client	UNS32	ro	580h + NID
1800	Transmit PDO1 Communication Parameter				
	0	Number of Entries	UNS8	ro	2
	1	COB-ID used by PDO	UNS32	ro	180h + NID
	2	Transmission Type	UNS8	ro	FEh
1A00	Transmit PDO1 Mapping Parameter				
	0	Number of Entries	UNS8	ro	4
	1	1. Mapped Object	UNS32	ro	50000110h
	2	2. Mapped Object	UNS32	ro	50000210h
	3	3. Mapped Object	UNS32	ro	50000310h
	4	4. Mapped Object	UNS32	ro	50000410h

3.4.1.1. Error Register (Index 1001h)

The error register shows the error status of the device. When an error occurs or adjusted limits are exceeded bit 0 is set (general error). The reason of this error is indicated with the manufacturer status register. The content of this error register is transmitted in every emergency message.

3.4.1.2. Manufacturer Status Register (Index 1002h)

This register shows the actual state of all detectable errors. Every bit stands for a specific error. If a bit is set this error is active. The buildup of this register is as follows.

Manufacturer Status Register			
Bit3	Bit2	Bit1	Bit0
Limit 4 µm	Limit 6 µm	Limit 14 µm	Flow Sensor

Bit 0 is set when no valid signal of the flow sensor is detected. Bits 1 – 3 are set when an adjusted limit value is exceeded and the report format is according ISO 4406. Bits 4 – 31 are unused. The content of this register is sent at every emergency message.

3.4.1.3. Store Parameter Field

The CCT01 supports saving parameters in non-volatile memory. With an reading access to the index 1010h, subindex 1h, the device answers with the value 1. That means that the device stores all parameters on command. Otherwise the parameters are only stored in RAM and get lost at a reset. The following telegramme is used to store the parameters.

Identifier	Byte1	Byte2	Byte3	Byte4	Byte5	Byte6	Byte7	Byte8
600h + NID	23h	10h	10h	01h	73h	61h	76h	65h

3.4.2. Manufacturer specific part

In this chapter the manufacturer specific part of the object dictionary is described. The following table shows the buildup of this part.

Index (hex)	Subindex (hex)	Description	Data type	Access	Default value
3000	0	Limit 4 µm	UNS8	rw	0
3001	0	Limit 6 µm	UNS8	rw	0
3002	0	Limit 14 µm	UNS8	rw	0
3003	0	Sending Measurement Results	UNS16	rw	1
4000	0	Storage Interval	UNS16	rw	0
4001	0	Number of stored data	UNS16	rw	0
4002	Stored Data1		RECORD	ro	
.
.
.
43E9	Stored Data1000		RECORD	ro	
5000	Process values as UNS16				
	0	Number of entries	UNS8	ro	4
	1	Contamination class 4 µm	UNS16	ro	(value)
	2	Contamination class 6 µm	UNS16	ro	(value)
	3	Contamination class 14 µm	UNS16	ro	(value)
	4	Volume flow	UNS16	ro	(value)
5100	Process values as REAL32				
	0	Number of entries	UNS8	ro	4
	1	Particles/ml > 4 µm	REAL32	ro	(value)
	2	Particles/ml > 6 µm	REAL32	ro	(value)
	3	Particles/ml > 14 µm	REAL32	ro	(value)
	4	Volume flow	REAL32	ro	(value)

3.4.2.1. Threshold settings

The indexes 3000h to 3002h of the object dictionary are for threshold settings. The limit values are according ISO 4406. The value "0" means a deactivation of limit value monitoring.

3.4.2.2. Sending Measurement results

Transmission of the PDO takes place after the number of measurements which can be changed Index 3003h. The time of one measurement is 20 seconds. That means that at a value of 1 the result is sent after every measurement (every 20 seconds). With a value of 0 the results are not transmitted.

3.4.2.3. Storage interval

The storage interval is at the index 4000h. The unit is hours and it can be changed between 0 (storage interval off) and 1000.

3.4.2.4. Stored data

At the index 4001h there is the number of the stored measurement results. 1000 measurements can be stored. Deletion can be made with a writing access to the index 4001h, subindex 0h and the value 0. The stored data are at the following indexes. The first possible data set is at index 4002h, the last one at index 43E9h. At a query of not existing data sets the abort code "06010000h" (Unsupported acces to an object) is sent. Following there is the buildup of one data set.

Index (hex)	Subindex (hex)	Description	Data type	Access	Default value
4002	0	Number of entries	UNS8	ro	9
	1	Day	UNS8	ro	
	2	Month	UNS8	ro	
	3	Year	UNS8	ro	
	4	Hour	UNS8	ro	
	5	Minute	UNS8	ro	
	6	Particles/ml > 4 µm	REAL32	ro	
	7	Particles/ml > 6 µm	REAL32	ro	
	8	Particles/ml > 14 µm	REAL32	ro	
	9	Volume flow	REAL32	ro	

3.4.2.5. Process values

Process values are contamination classes acc. ISO4406 and the volume flow through the measuring channel. The variables are located at index 5000h as UNS16 – values and at index 5100h as REAL32 – values. The unit of the volume flow is ml/min.

3.5. SDO (Service Data Object)

With Service Data Objects the access to entries of a device Object Dictionary is provided. It is a client-server communication. A client request is always confirmed by a reply from the server. The CCT01 represents an SDO-Server.

For an SDO transfer following COB-IDs are used:

COB-ID	Description
0x600 + Node ID	SDO Client → CCT01
0x580 + Node ID	CCT01 → SDO Client

At an SDO the 8 byte data consist of the Command Specifier (CS), a 16 – Bit index, an 8 – Bit subindex and maximum 4 byte data. The buildup is shown in the next illustration.

Byte 0	Byte 1	Byte 2	Byte 3	Byte 4	Byte 5	Byte 6	Byte 7
CS	Index		Subidx	Data			

At an SDO request the Command Specifier indicates the type of request (read or write). With a writing acces it contains also information about the number of bytes in the data field. At an SDO response the Command Specifier indicates the success of the request. At a reading request it also contains information about the number of bytes in the data field. When the request was not successful the data field contains a 4 byte error code. The meaning of these error codes is described in the specification DS-301.

CS (hex)	Description	Type of telegramme
2F	Write 1 Byte	Request
2B	Write 2 Byte	Request
27	Write 3 Byte	Request
23	Write 4 Byte	Request
60	Writing successful	Response
80	Error	Response
40	Reading request	Request
4F	1 Byte data	Response
4B	2 Byte data	Response
47	3 Byte data	Response
43	4 Byte data	Response

The CCT01 supports only the transmission of data with a maximum length of 4 Byte!

3.6. Transmit PDO

The CCT01 has one Transmit PDO (TPDO). This contains the measurement results in contamination classes according ISO 4406 and the volume flow through the measuring channel. The identifier is static (180h + Node ID). The transmission type is 254 und also static. That means the transmission type is defined in the manufacturer specific part of the object dictionary. It was described in section 3.4.2.2. PDO Mapping is also static and it is described in the next illustration.

Byte 0	Byte 1	Byte 2	Byte 3	Byte 4	Byte 5	Byte 6	Byte 7
Idx 5000, Sidx 1		Idx 5000, Sidx 2		Idx 5000, Sidx 3		Idx 5000, Sidx 4	

The Transmit PDO can also be requested with a Remote Frame.

3.7. Emergency Messages

With an exceeding of the limit values or with an error of the flow sensor an emergency message will be sent. The identifier is 80h + Node ID. The message consists of the Emergency Error Code, the Error Register and the Manufacturer Status Register. The type of error is indicated by the Manufacturer Status Register (3.4.1.2).

Byte 0	Byte 1	Byte 2	Byte 3	Byte 4	Byte 5	Byte 6	Byte 7
Emergency Error Code		Error Reg.	Manufacturer Status Register				unused

3.8. Guarding

For guarding Heartbeat- or Nodeguarding-mechanism can be used. It can only be used one error control mechanism at the same time.

3.8.1. Nodeguarding

The CCT01 only supports Nodeguarding. Lifeguarding is not supported. An NMT Master cyclically sends a remote frame to an NMT Slave. The identifier is 700h + Node ID. The response of the NMT slave contains the state of that NMT Slave and an alternating toggle bit. An error is indicated if the remote transmit request is not confirmed within the node life time or the reported NMT slave state does not match the expected state. Nodeguarding is only possible when the parameter "Producer Heartbeat Time" (1017h) is 0.

3.8.2. Heartbeat

The Heartbeat mechanism defines an Error Control Service without need for remote frames. A Heartbeat Producer transmits a Heartbeat message cyclically. The identifier is 700h + Node ID and it contains the MT state of the NMT Slave. It is activated when the parameter "Producer Heartbeat Time" (1017h) is bigger than 0.

3.9. Timestamp

The Timestamp-Object can be used for setting the time. This protocol is a timestamp with a length of 6 Byte. It consists of the days since 1. January 1984 and the milliseconds after midnight. The default value of the identifier is 100h. It can be changed at the index 1012h. A receipt for the timestamp is only possible in the state Pre-Operational and when the MSB of the Object 1012h is 1.

3.10. Network Management

The state machine is implemented according DS-301. The CCM01 supports the following orders:

- Start Remote Node
- Stop Remote Node
- Enter Pre-Operational
- Reset Node
- Reset Communication

3.11. EDS-file

For the CCT01 an electronic data sheet (EDS-file) is available. It contains a complete description of the object dictionary and it serves for an easy integration in a CANopen configuration tool.

3.12. Examples for CAN-communication

In this chapter there are some examples for controlling the CCT01 via CAN. All numbers are in hexadecimal representation.

Node ID 5, request limit 4 μ m:

	Identifier	8 Byte Data
Client	605	40 00 30 00 00 00 00 00
Response CCT01	585	4F 00 30 00 xx 00 00 00

Node ID 15, request particle number 1. channel:

	Identifier	8 Byte Data
Client	60F	40 00 51 01 00 00 00 00
Response CCT01	58F	43 00 51 01 xx xx xx xx

Node ID 15, Start Remote Node:

	Identifier	2 Byte
Master	0	01 0F or 01 00

4. Sensor calibration

- The laser sensor is calibrated with ISO MTD according to ISO 11171 and is delivered together with a calibration certificate.
- The validity of the calibration certificate amounts to 12 months.

- Eaton recommends a calibration interval of 1 year. For the calibration send the sensor and the CCT 01 to Eaton Technologies GmbH in Altlußheim.
- The calibration and maintenance package for the sensor and the CCT 01 contains:
 - Function test of the sensor and the CCT 01
 - Calibration with calibration certificate
 - Programming of the new calibration values in the CCT 01
 - 24 h function test

- Upon delivery the calibration values of the attached laser sensor are programmed in the CCT 01.
- When only the PFS 01 sensor was sent to calibration, the calibration values must be entered into the CCT 01.
- If the laser sensor is recalibrated or exchanged, also the programmed calibration values in the CCT 01 have to be changed. The input of the new calibration values is described in chapter 2.6.2.5.2.5.

5. Appendix

5.1. Technical Data

5.1.1. Laser sensor PFS 01:

Measuring principle:	Particle counting based on the light-barrier principle
Calibration:	ISO MTD in oil (ISO 11171:2000)
Coincidence limit:	10.000 particles / ml
Maximum acceptable operating pressure:	≤ 50 bars / ≤ 725 psi
Maximum oil temperature:	70 °C / 158 °F
Viscosity range:	10.....400 mm ² /s / 45...1854 SUS
Ambient temperature:	0...+ 70 °C / 32...158 °F
Minimum volume flow:	500 ml/ min / 0,132 gal/ min
Maximum acceptable volume flow:	50 l/min / 13,3 gal/min
Connections:	Pipes 1" or ¾"
Protection class:	IP 65
Mass:	1,5 kg / 3,3 lb (m)
Operating fluids:	Mineral oil based hydraulic- and lubricating fluids (check separate list 5.5)

5.1.2. CCT 01 – Contamination Class Transmitter:

Measuring system:	automatic particles counting
Particle sizes:	> 4 μm _(c) , > 6 μm _(c) , >14 μm _(c)
Representation of the cc:	ISO 4406 (4 - 25)
Accuracy: (Contamination classes)	± 1
Ambient temperature:	0 ...+ 70 °C / 32...158 °F
Material:	Aluminum
Power supply:	24 V DC
Analog outputs:	3 x 4...20 mA
Max. burden:	450 Ω
Protection class:	IP 65
Memory capacity:	up to 1000 measurements
Connections:	M12 - socket - for power outputs Socket - 7 poles - DIN 45321 M8 - plug 3 poles power supply M12 - plug CAN-Bus
Interfaces:	USB (for configuration) CAN: ISO 11898, CAN 2.0A, CANopen kompatibel
Dimensions:	201 x 85 x 35 mm x mm x mm
Mass:	380 g

5.2. Pin Assignment

CON 2:

Brown:	+ 24 V	1
Blue:	GND	3
Black:	RESERVED	4

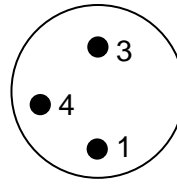

**M 8
Plug**

CON 1:

Brown:	+ 24 V	1
White:	4 μ	2
Blue:	6 μ	3
Black:	GND	4
Grey:	14 μ	5

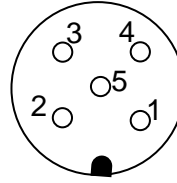

**M 12
Socket**

CAN:

Brown:	CAN Shield	1
White:	NC	2
Blue:	GND	3
Black:	CAN H	4
Grey:	CAN L	5

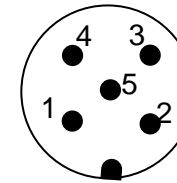

**M 12
Plug**

5.3. Assembly instructions

Dimensions in mm, unless specified otherwise

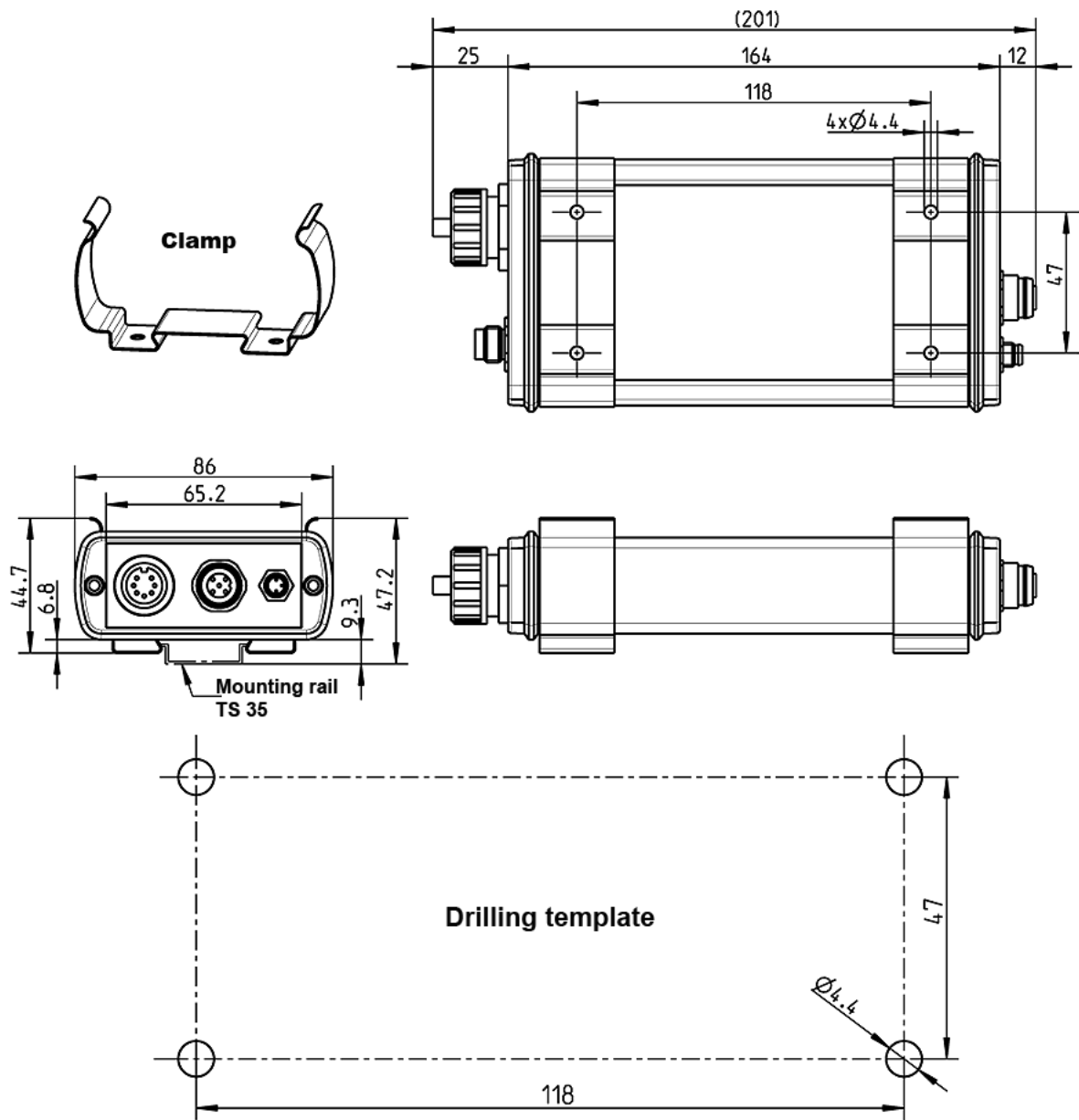

5.4. Cleanliness classes according to ISO 4406:99

According to ISO 4406 (year 1999) the number of particles sized $> 4 \mu\text{m}$, $> 6 \mu\text{m}$ and $> 14 \mu\text{m}$ is being used to determine the cleanliness class. The determination of the cleanliness class doesn't depend on the particle size.

Die Bestimmung der RK ist unabhängig von der Partikelgröße.

Example of presenting:

20 / 16 / 12

Partikel $> 14 \mu\text{m}$

Partikel $> 6 \mu\text{m}$

Partikel $> 4 \mu\text{m}$

Analysis volume: 1 ml

Cleanliness class	Number of particles	Up to and including
26	320000	640000
25	160000	320000
24	80000	160000
23	40000	80000
22	20000	40000
21	10000	20000
20	5000	10000
19	2500	5000
18	1300	2500
17	640	1300
16	320	640
15	160	320
14	80	160
13	40	80
12	20	40
11	10	20
10	5	10
9	2,5	5
8	1,3	2,5
7	0,6	1,3
6	0,3	0,6

5.5. Fields of Application - Compatibility

- Hydraulic oils H, HL, HLP, and HV
- Transmission oils C, CL, CLP
- Motor oils, gas oils
- MIL-H-5606 E
- Vegetable oils (HTG, triglyceride)
- Synthetic ester (HEES)

5.6. Trouble Shooting

No parts of the CCT 01 ought to be exchanged by the operator.

Malfunctions, which could be eliminated by the operator, are limited to check the cables.

Any other case the sensor or the contamination class transmitter CCT 01 has to be send to **Eaton Technologies GmbH** in order to recover the functions.

A brief description of the problem would expedite the trouble shooting and the repair process. To check your warranty and to answer questions by phone, we need the serial number and the date of purchase of the instrument.

5.7. Shipment



Article no.:

(1) Transmitter CCT 01	328597
(2) Sensor PFS 01	327213
(3) Sensor cable, L = 5 m	328684
(4) FEB connector plug	328685
(5) FEB cable 3308 PS, L = 5 m	328686
(6) USB – cable	328687
(7) Mounting clamp	328663
(8) Data manager 2.0 CD (incl. CCT 01 driver)	327284
(9) Instruction manual	328690

North America — HQ

70 Wood Ave., South, 2nd Floor
Iselin, NJ 08830
Toll Free: (800) 656-3344
(North America Only)
Voice: (732) 767-4200

China

No. 3, Lane 280, Linhong Road
Changning District, 200335
Shanghai, P.R. China
Voice: +86-21-5200-0099

Singapore

4 Loyang Lane #04-01/02
Singapore 508914
Voice: +65-6825-1668

Europe/Africa/Middle East

Friedensstraße 41
D-68804 Altlussheim, Germany
Voice: +49-6205-2094-0

Auf der Heide 2
53947 Nettersheim, Germany
Voice: +49-2486-809-0

An den Nahewiesen 24
55450 Langenlonsheim, Germany
Voice: +49 6704 204-0

Brazil

Av. Julia Gaioli, 474 –
Bonsucesso
07251-500 – Guarulhos, Brazil
Voice: +55 (11) 2465-8822

For more information, please e-mail us at filtrationinfo@eaton.com

Visit us online eaton.com/filtration for a complete list of Eaton's filtration products.

©2012 Eaton Corporation. All Rights Reserved.
All trademarks and registered trademarks are the property of their respective owners. Litho USA.

All information and recommendations appearing in this brochure concerning the use of products described herein are based on tests believed to be reliable. However, it is the user's responsibility to determine the suitability for his own use of such products. Since the actual use by others is beyond our control, no guarantee, expressed or implied, is made by Eaton as to the effects of such use or the results to be obtained. Eaton assumes no liability arising out of the use by others of such products. Nor is the information herein to be construed as absolutely complete, since additional information may be necessary or desirable when particular or exceptional conditions or circumstances exist or because of applicable laws or government regulations.



Powering Business Worldwide

