

# Installation, operation and maintenance instructions for Flowrox™ FXM peristaltic metering tube pumps

Installation, maintenance and operating instructions



These instructions must be read carefully and understood prior to the installation, use, and servicing of this product.

## DISCLAIMER

ALL DRAWINGS, SPECIFICATIONS, DATA, SOFTWARE, FIRMWARE, MANUALS, INSTRUCTIONS, DOCUMENTATION OR OTHER WORKS OF AUTHORSHIP FURNISHED BY VALMET ARE COPYRIGHTED PROPERTY OF VALMET OR ITS SUPPLIERS, AND ARE TO BE USED BY CUSTOMER, PURCHASER, SUBCONTRACTOR, SUPPLIER OR OTHER AUTHORIZED PERSONS (“USERS”) ONLY FOR THE PURPOSE OF INSTALLING, OPERATING, MAINTAINING AND REPAIRING THE GOODS AND SERVICES SUPPLIED BY VALMET (“PRODUCTS”). SUCH WORKS AND DATA MAY NOT BE OTHERWISE USED OR REPRODUCED OR DISCLOSED. VALMET OR ITS SUPPLIERS RETAIN ALL RIGHT, TITLE AND INTEREST IN AND TO ITS AND THEIR INVENTIONS, DISCOVERIES, CONCEPTS, IDEAS OR OTHER INTELLECTUAL PROPERTY EMBODIED IN OR RELATED TO ITS PRODUCTS.

ANY AND ALL TRADE SECRETS, SPECIFICATIONS, DRAWINGS, DESIGNS, SOFTWARE, SAMPLES, OTHER TECHNICAL, FINANCIAL, PRODUCT, MARKETING, SALES, PRODUCTION, SUBCONTRACTING, PRICING AND OTHER CONFIDENTIAL AND/OR PROPRIETARY INFORMATION OF A PARTY PERTAINING TO THE PRODUCTS OR OTHERWISE TO THIS CONTRACT, OR TO A PARTY, ITS PRODUCTS, BUSINESSES, OPERATIONS, OR PLANS, SHALL NOT BE DISCLOSED TO ANY UNAUTHORIZED THIRD PARTY BY THE OTHER PARTY. THE RECEIVING PARTY SHALL ENSURE THAT ITS DIRECTORS, OFFICERS, EMPLOYEES AND AGENTS COMPLY WITH THE OBLIGATIONS HEREIN. UNLESS OTHERWISE AGREED TO IN WRITING BY THE PARTIES, THE PARTIES' CONFIDENTIALITY, NON-DISCLOSURE AND NON-USE OBLIGATIONS HEREIN SHALL REMAIN IN FORCE TO THE MAXIMUM TERM PERMITTED BY APPLICABLE LAW.

THIS MANUAL PROVIDES INSTRUCTIONS TO CARRY OUT CERTAIN ACTIVITIES AND IS DESIGNED AND MEANT TO GUIDE AND ASSIST PROFESSIONAL AND PROPERLY TRAINED EXPERTS IN PERFORMING THEIR FUNCTIONS. EVERYONE MUST BECOME FAMILIAR WITH ALL INSTRUCTIONS IN THIS MANUAL BEFORE ANY INSTALLATION, USE, MAINTENANCE, REPAIR OR ANY OTHER ACTIONS OF THE RESPECTIVE GOODS AND/OR SERVICES WHICH THIS MANUAL APPLIES TO. ALL INSTRUCTIONS MUST BE FOLLOWED CAREFULLY. HOWEVER, OBSERVANCE OF ANY PART OF THE INSTRUCTIONS PRESENTED IN THIS MANUAL MAY BE OMITTED IN EVENT WHEN IT IS REQUIRED OR ALLOWED BY LAW. VALMET HAS TAKEN EVERY CARE IN THE PREPARATION OF THE CONTENT OF THIS MANUAL, BUT DOES NOT MAKE ANY REPRESENTATIONS, WARRANTIES OR GUARANTEES OR, EXPRESS OR IMPLIED, AS TO THE ACCURACY OR COMPLETENESS OF THIS MANUAL.

ALL USERS MUST UNDERSTAND AND BE AWARE THAT UPDATES AND AMENDMENTS WILL BE MADE FROM TIME TO TIME TO THIS MANUAL. ALL USERS ARE OBLIGATED TO FIND OUT AND DETERMINE WHETHER THERE HAVE BEEN ANY APPLICABLE UPDATES OR AMENDMENTS TO THIS MANUAL. NEITHER VALMET NOR ANY OF ITS DIRECTORS, OFFICERS, EMPLOYEES, SUBCONTRACTORS, SUB-SUPPLIERS, REPRESENTATIVES OR AGENTS SHALL BE LIABLE IN CONTRACT, TORT OR IN ANY OTHER MANNER WHATSOEVER TO ANY PERSON FOR ANY LOSS, DAMAGE, INJURY, DEATH, LIABILITY, COST OR EXPENSE OF ANY NATURE, INCLUDING WITHOUT LIMITATION INDIRECT, INCIDENTAL, SPECIAL, CONSEQUENTIAL, PUNITIVE OR DIRECT DAMAGES AND/OR LOSSES ARISING OUT OF OR IN CONNECTION WITH THE CREATION, DELIVERY, POSSESSION AND/OR USE OF THIS MANUAL. HOWEVER, NOTHING IN THIS PARAGRAPH IS DEEMED TO EXCLUDE OR RESTRICT ANY LIABILITY WHICH CANNOT BY MANDATORY LAW BE EXCLUDED.

FLOWROX™ IS EITHER REGISTERED TRADEMARK OR TRADEMARK OF VALMET OR ITS SUBSIDIARIES OR AFFILIATES IN THE UNITED STATES AND/OR IN OTHER COUNTRIES. ALL OTHER TRADEMARKS, LOGOS, BRANDS AND MARKS DISPLAYED IN THIS MANUAL ARE PROPERTY OF THE RESPECTIVE OWNERS UNLESS STATED OTHERWISE.

Copyright © 2014-2023 Valmet Corporation. All rights reserved.

# Table of Contents

<b>1 EU DECLARATION OF CONFORMITY</b>	<b>4</b>
1.1 Introduction	5
1.2 Available Models	5
1.3 Specifications	7
1.4 Materials of construction	8
1.5 Features	8
1.6 Agency Listings	9
<b>2 Installation</b>	<b>10</b>
2.1 Mounting Location	10
2.2 Dimensions	11
2.3 Installing Suction Strainer	12
2.4 Input Power Connections	12
2.5 WIRING TERMINALS AND I/O SCHEMATICS	14
<b>3 How To Operate FXM</b>	<b>16</b>
3.1 Menu Navigation	17
3.2 Configuration Menu	18
<b>4 Input Setup</b>	<b>23</b>
4.1 MAX Flowrate (output calibration)	25
4.2 Contact Input	32
4.3 Remote/Local Control	32
4.4 Conditional Contact Input Naming	33
4.5 Conditional Logic Control	33
<b>5 Output setup ( alarm relays )</b>	<b>34</b>
5.1 Signal Output	35
<b>6 Pump Maintenance</b>	<b>36</b>
6.1 Routine Inspection and Maintenance	36
6.2 How to Clean and Lubricate the Pump	36
6.3 Reverse Rotor Rotation	36
6.4 Tube Replacement	37
6.5 FLOWROX Model FXM2 replacement parts list	40
6.6 FLOWROX Model FXM3 replacement parts list	42

<b>APPENDICES</b>	<b>44</b>
Warranty	44

## READ THESE INSTRUCTIONS FIRST!

These instructions provide information about safe handling and operation of the product.

If you require additional assistance, please contact the manufacturer or manufacturer's representative.

## SAVE THESE INSTRUCTIONS!

Addresses and phone numbers are printed on the back cover.

# 1 EU DECLARATION OF CONFORMITY

This declaration is issued under the sole responsibility of the manufacturer:

Valmet Flow Control Oy

Marsitie 1

53600 Lappeenranta

Finland

Tel. +358 (0)10 417 5000

Product model/type: FXM Peristaltic Metering Tube Pump

The object of the declaration described above is in conformity with the relevant Union harmonisation legislation:

Machinery Directive 2006/42/EC: Annex II A

Electro-Magnetic Compatibility Directive 2014/30/EU

Low Voltage Directive 2014/35/EU

Follow the pump installation, operating and maintenance instructions in this manual.

Person authorised to compile the technical file is Technology Manager Jarmo Partanen.

On behalf of Valmet Flow Control Oy

In Lappeenranta, 13th May 2022



Riku Salojärvi

Head of Operations

## 1.1 Introduction

Congratulations on purchasing the Flowrox variable speed Peristaltic Metering Pump.

Your Flowrox pump is pre-configured for the tubing that shipped with your metering pump.

	<p>Flowrox FXM pumps are for industrial and laboratory applications. Only qualified personnel is allowed to install and operate the pump.</p>
---	---

## 1.2 Available Models

Feed rate		Max Speed	Max Pressure	FXM2 Model Numbers				
<b>FXM2 Tube Pumps Norprene®</b>								
<b>Meets FDA criteria for food   Excellent chemical resistance   CIP   SIP</b>								
liter/h (gal/h)	ml/min (oz/min)	RPM	bar (psi)	115V AC (US)	230V AC (US)	230V AC (EU)	230V AC (UK)	230V AC (AUS)
.002 - 11 (0.0005 - 2.9)	.04 - 183 (0.0014 - 6.2)	175	8.6 (125)	FXM2-S-34-N011	FXM2-S-35-N011	FXM2-S-36-N011	FXM2-S-37-N011	FXM2-S-38-N011
.018 - 92 (0.0048 - 24.3)	.3 - 1533 (0.010 - 52.5)	175	8.6 (125)	FXM2-S-34-N092	FXM2-S-35-N092	FXM2-S-36-N092	FXM2-S-37-N092	FXM2-S-38-N092
.035 - 176 (0.009 - 46.5)	.6 - 2933 (0.020 - 99.2)	175	2.1 (30)	FXM2-S-34-N176	FXM2-S-35-N176	FXM2-S-36-N176	FXM2-S-37-N176	FXM2-S-38-N176
<b>FXM2 Tube Pumps Tygon lined Norprene®</b>								
<b>Meets FDA criteria for food   Superior chemical resistance</b>								
liter/h (gal/h)	ml/min (oz/min)	RPM	bar (psi)	115V AC (US)	230V AC (US)	230V AC (EU)	230V AC (UK)	230V AC (AUS)
.030 - 165 (0.008 - 43.6)	.5 - 2750 (0.017 - 93.0)	175	3.5 (50)	FXM2-S-34*-T165	FXM2-S-35*-T165	FXM2-S-36*-T165	FXM2-S-37*-T165	FXM2-S-38*-T165
<b>FXM2 Tube Pumps Tygothane®</b>								
<b>Meets FDA criteria for food   Resistant to oils, greases and fuels</b>								
liter/h (gal/h)	ml/min (oz/min)	RPM	bar (psi)	115V AC (US)	230V AC (US)	230V AC (EU)	230V AC (UK)	230V AC (AUS)
.030 - 162 (0.008 - 42.8)	.5 - 2700 (0.017 - 91.3)	175	4.5 (65)	FXM2-S-34*-G162	FXM2-S-35*-G162	FXM2-S-36*-G162	FXM2-S-37*-G162	FXM2-S-38*-G162

Feed rate		Max	Max	FXM2 Model Numbers				
		Speed	Pressure					
<b>FXM3 Tube Pumps Norprene®</b>								
<b>Meets FDA criteria for food   Excellent chemical resistance   CIP   SIP</b>								
liter/h (gal/h)	ml/min (oz/min)	RPM	bar (psi)	115V AC (US)	230V AC (US)	230V AC (EU)	230V AC (UK)	230V AC (AUS)
.05 - 268 (0.013 - 70)	0.9 - 5617 (0.030 - 189.9)	175	2.1 (30)	FXM3-S-34*-N269	FXM3-S-35*-N269	FXM3-S-36*-N269	FXM3-S-37*-N269	FXM3-S-38*-N269
.11 - 529 (0.029 - 139.7)	1.8 - 8550 (0.061 - 289.1)	175	3.4 (50)	FXM3-S-34*-N529	FXM3-S-35*-N529	FXM3-S-36*-N529	FXM3-S-37*-N529	FXM3-S-38*-N529
.17 - 840 (0.045 - 221.9)	2.8 - 14000 (0.095 - 473.4)	175	2.1 (30)	FXM3-S-34*-N840	FXM3-S-35*-N840	FXM3-S-36*-N840	FXM3-S-37*-N840	FXM3-S-38*-N840
<b>FXM3 Tube Pumps Tygon lined Norprene®</b>								
<b>Meets FDA criteria for food   Superior chemical resistance</b>								
liter/h (gal/h)	ml/min (oz/min)	RPM	bar (psi)	115V AC (US)	230V AC (US)	230V AC (EU)	230V AC (UK)	230V AC (AUS)
.06 - 307 (0.016 - 81.2)	1.0 - 6167 (0.034 - 208.5)	175	2.1 (30)	FXM3-S-34*-T300	FXM3-S-35*-T300	FXM3-S-36*-T300	FXM3-S-37*-T300	FXM3-S-38*-T300
<b>FXM3 Tube Pumps Tygothane®</b>								
<b>Meets FDA criteria for food   Resistant to oils, greases and fuels</b>								
liter/h (gal/h)	ml/min (oz/min)	RPM	bar (psi)	115V AC (US)	230V AC (US)	230V AC (EU)	230V AC (UK)	230V AC (AUS)
.06 - 350 (0.016 - 94.2)	1.0 - 5833 (0.034 - 197.2)	175	4.5 (65)	FXM3-S-24*-G350	FXM3-S-35*-G350	FXM3-S-36*-G350	FXM3-S-37*-G350	FXM3-S-38*-G350

- The Flowrox Peristaltic Pump's motor speed is linear over the entire 0.02% to 100% adjustment range.
- Output versus pressure is nearly linear in all models. Larger tubes exhibit greater losses.
- The pressure, temperature, operational speed, application media and viscosity will affect hose lifetime.
- For optimum tube life, specify the pump so that it operates at the lowest possible RPM and pressure.

\* Inlet/outlet connection type:  
blank = 3/8" OD x 1/4" ID tubing compressions type connections (available on FXM2 only)  
P = 1/2" NPT external  
B = 1/2" ID hose barb type connections (available on FXM3 models only)

## 1.3 Specifications

### Maximum working pressure (excluding pump tubes):

FXM2: 8.6 bar / 125 psi

FMX3: 4.5 bar / 65 psi

Note: see individual pump tube assembly maximum pressure ratings in Section 1.2 (Available Models)

### Maximum Fluid temperature:

54°C / 129°F

### Minimum and maximum ambient operating or storage temperature:

0°C to 46°C / 32° to 115°F

### Operating Voltage:

FXM-M2 MODELS: 96 to 264VAC-50/60Hz, 190W

FXM-M3 MODELS: 96 to 264VAC-50/60Hz, 190W

### Power Cord Options:

115V60Hz = NEMA 5/15 (USA)

230V60Hz = NEMA 6/15 (USA)

230V50Hz = CEE 7/VII (EU)

230V50Hz = BS 1363 (UK)

230V50Hz = AS 3112 (Australia/New Zealand)

### Enclosure:

NEMA 4X (IP66), Polyester powder coated aluminum.

### Maximum Overall Dimensions:

FXM-M2 models (WxHxD): 236 mm x 307 mm x 329 mm

FXM-M3 models (WxHxD): 320 mm x 383 mm x 387 mm

### Approximate shipping wt:

FXM-M2 models: 14.0 kg / 31 lbs.

FXM-M3 models: 22.0 kg /48.5 lbs.

### Motor speed adjustment range 5.000:1:

0.02% - 100% motor speed

### Motor speed adjustment resolution:

0.1% increments > 1% motor speed

0.01% increments > 0.2% - 1% motor speed

### Maximum viscosity:

5,000 centipoise

### Maximum suction lift:

9 m, 0.9 bar / 29.5 ft, 13 psi

### Display

3.5" Backlit high resolution

### Display Languages

English, Spanish, French, German, Russian or Finnish selectable.

### Keypad

Eleven button positive action tactile switch keypad.

### Security

Programmable 4-digit password.

### Other:

Indoor use only

Altitude: up to 2000 m / 6561.7 ft

Humidity: 0-95% RH

Mains fluctuations: +/- 10%

Overvoltage category: II

Wet location: no

Pollution degree: 2

## 1.4 Materials of construction

Wetted components:

**Pump Tube Assembly (Model Specific - 2 provided):**

Tubing: . . . . . Norprene<sup>□</sup> or Tygon lined Norprene<sup>□</sup>  
or Tygothane<sup>□</sup>

Adapter fittings: . . . . . PVDF

**Connections tubings:**

**Suction Tubing:** . . . . . 3/8" OD x 1/4" ID x 10' Clear PVC (FXM2)

**Discharge Tubing:** . . . . . 3/8" OD x 1/4" ID x 10' Polyethylene (FXM2)

**Suction Strainer:** . . . . . Polypropylene

Non-Wetted components:

**Enclosure:**

A356 (AlSi7Mg) Aluminum (Polyester powder coated)

**Pump Head:**

PBT GF30

**Pump Head Cover:**

Clear Acrylic

Permanently lubricated sealed motor shaft support ball bearing.

Cover Screws:

Stainless Steel Thumb Screws

**Roller Assembly:**

**Rotor:** . . . . . PBT GF30

**Rollers:** . . . . . POM

**Roller Bearings:** . . . . . Ball Bearings

**Motor Shaft:**

Chrome plated steel

**Tube Leak Detection (TLD) System Sensor pins, non-contact:**

Brass

**Power Cord and Connector:**

Power cord with plug (see page 7, 14) and Amphenol female pin connector type DC-03BFFB

Connector in pump PWF-03-PMMS SC7001, male pins copper alloy

**Mounting plate:**

Stainless steel AISI 316

## 1.5 Features

- Peristaltic pump design does not have valves that can clog requiring maintenance.
- Self priming even against maximum line pressure. By-pass valves are not required. Cannot vapor lock or lose prime. Siphoning cannot occur.
- Output rates to: 840 liter/h and pressures up to 8.6 bars.
- No maintenance brushless variable speed motor.
- Specially engineered tubing for long life at high pressures.
- Non-contact capacitive Tube Leak Detection (TLD) system. Senses tube failure by detecting chemical in the pump head. No false triggering.
- 5000:1 turndown ratio.
- SCADA Inputs include: 4-20mA, 0-10VDC, and Pulse inputs for remote external speed control and 0-30 VDC / contact closure remote start/stop.
- Operator friendly digital touch pad with menu driven software.
- Multi-color backlit LCD displays remote/local control status, motor speed, output rate, input signal values, service and alarm status.
- Outputs include: Scalable 4-20mA or pulse, one 250V/6A relay and four 125VAC 0.5Amp / 30VDC 2Amp contact closures assignable to monitor up to 17 different pump functions including TLD, FVS, remote/local control setting, motor on, fault, current operating mode, and others.
- Two CNC precision machined squeeze rollers and two alignment rollers for optimum squeeze, unparalleled accuracy, and tube life.
- Heavy duty rotor - plastic rotor means no flexing and increased accuracy (no metal springs or hinges to corrode).
- Inject at maximum pressure in either direction (clockwise and counter clockwise).
- Compatible with output Flow Verification Sensor (FVS) system.
- Auto-restart feature which will restore pump to operating state it was in when power was lost.





**Enclosure Rating:**

**NEMA 4X:** Constructed for either indoor or outdoor use to provide a degree of protection to personnel against incidental contact with enclosed equipment; to provide a degree of protection against falling dirt, rain, sleet, snow, windblown dust, splashing water, and hose-directed water; and that will be undamaged by external formation of ice on enclosure.







**IP66:** No ingress of dust; complete protection against contact. Water projected in powerful jets against enclosure from any direction shall have no harmful effects.







**1.6 Agency Listings**

	<p>This pump is MET listed (E115105) to conform to the following:          UL Standard 778, 6<sup>th</sup> edition, Motor-Operated Water Pumps          Certified to CAN/CSA Standard C22.2 No. 108-14, 5<sup>th</sup> edition, Liquid Pumps          EN 61010-1, Safety requirements for electrical equipment for measurement, control, and laboratory use - Part 1: General requirements</p>
	<p>Low Voltage Directive 2014/35/EU          EMC Directive 2014/30/EU          Machinery Directive 2006/42/EC</p>



In this manual, the following symbols are used to highlight the parts requiring particular attention:

Hazard severity panels.

	<p> <b>DANGER!</b></p> <p>DANGER indicates a hazard with a high level of risk which, if not avoided, will result in death or serious injury.</p>
	<p> <b>WARNING!</b></p> <p>WARNING indicates a hazard with a medium level of risk which, if not avoided, could result in death or serious injury.</p>
	<p> <b>CAUTION!</b></p> <p>CAUTION indicates a hazard with a low level of risk which, if not avoided, could result in minor or moderate injury.</p>

Symbol	Explanation
	<p><b>Risk to personal safety:</b>          Neglecting the safety measures can cause serious injury or death.</p>
	<p><b>Electrocution hazard.</b></p>
	<p><b>Crushing hazard.</b></p>
	<p><b>Read the operation and maintenance instructions:</b>          Read and understand the operation and maintenance instructions before using the product.</p>
	<p><b>Mandatory action symbol:</b>          Obey these instructions to prevent machine malfunctions.</p>
	<p><b>Ground, Protective Conductor Terminal</b></p>

## 2 Installation

	Risk of chemical overdose. Make sure pump does not overdose chemical during backwash and periods of no flow in circulation system.
	Always wear protective clothing, face shield, safety glasses and gloves when working on or near your metering pump. Additional precautions should be taken depending on solution being pumped. Refer to MSDS precautions from your solution supplier.
	All diagrams are strictly for guideline purposes only. Always consult an expert before installing metering pump on specialized systems. Metering pump should be serviced by qualified persons only.

### 2.1 Mounting Location

Choose an area located near chemical supply tank, chemical injection point, and electrical supply. Install pump where it can be easily serviced. Note, Pump is not certified for classified EX/ATEX areas

- Mount pump to a secure surface using fixing plate.
- Mount pump close to injection point. Keep inlet (suction) and outlet (discharge) tubing as short as possible. Longer discharge tubing increases back pressure at pump head.
- A backflow prevention check valve is recommended at the discharge of the pump to prevent system fluid from flowing back through the pump during tube replacement or if the tube should rupture.
- A pressure relief valve is recommended at the discharge of the pump to prevent premature wear and damage to the pump tube in the event the discharge line becomes blocked.
- The FXM does not require back pressure. Pressure regulator valves are not required. Keep the discharge pressure as low as possible to maximize tube life.
- An anti-siphon valve is not required, siphoning cannot occur.

## 2.2 Dimensions

Dimensions in mm (inches in parenthesis)

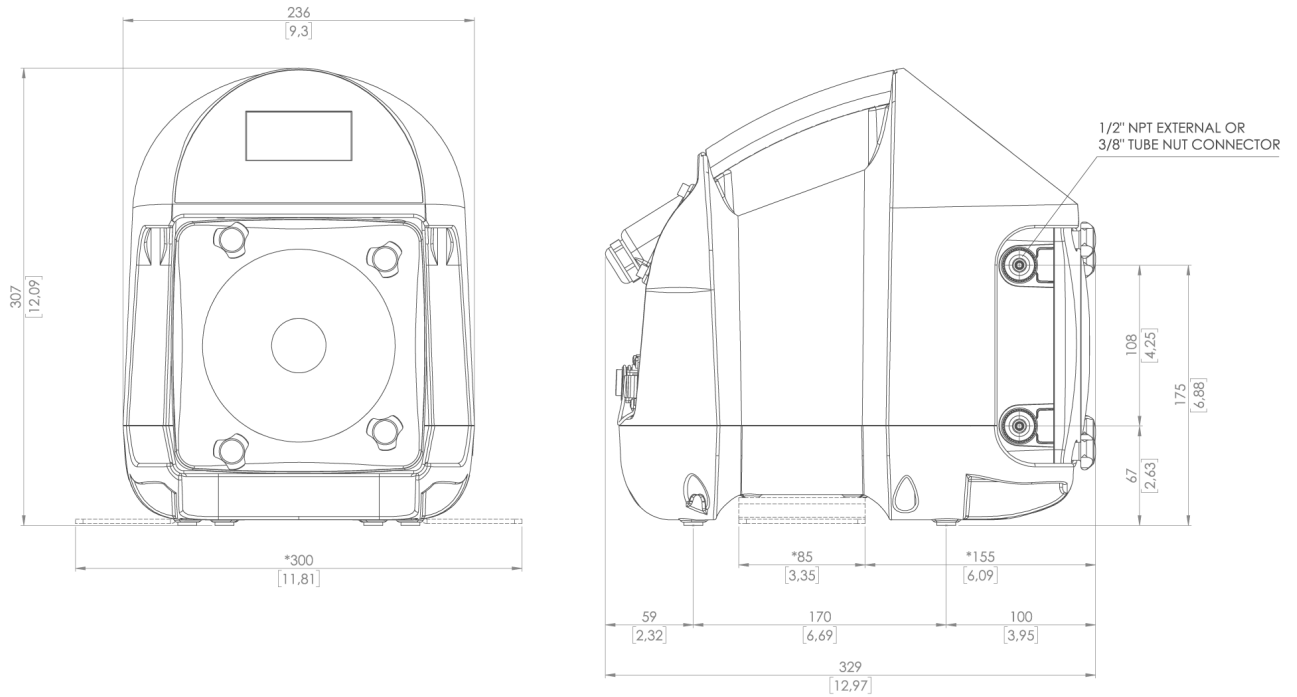

FXM2:

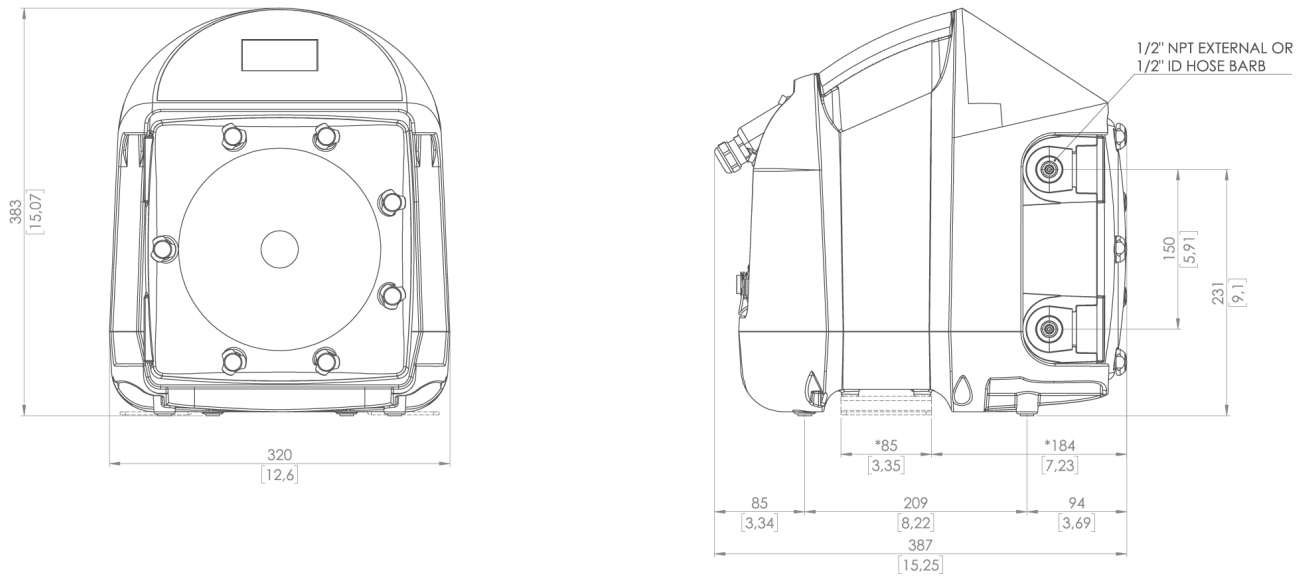

FXM3:



## 2.3 Installing Suction Strainer

	Proper eye and skin protection must be worn when installing and servicing pump.
	This pump has been evaluated for use with water only.

Suction tube strainer, dimensions valid for FXM2 only

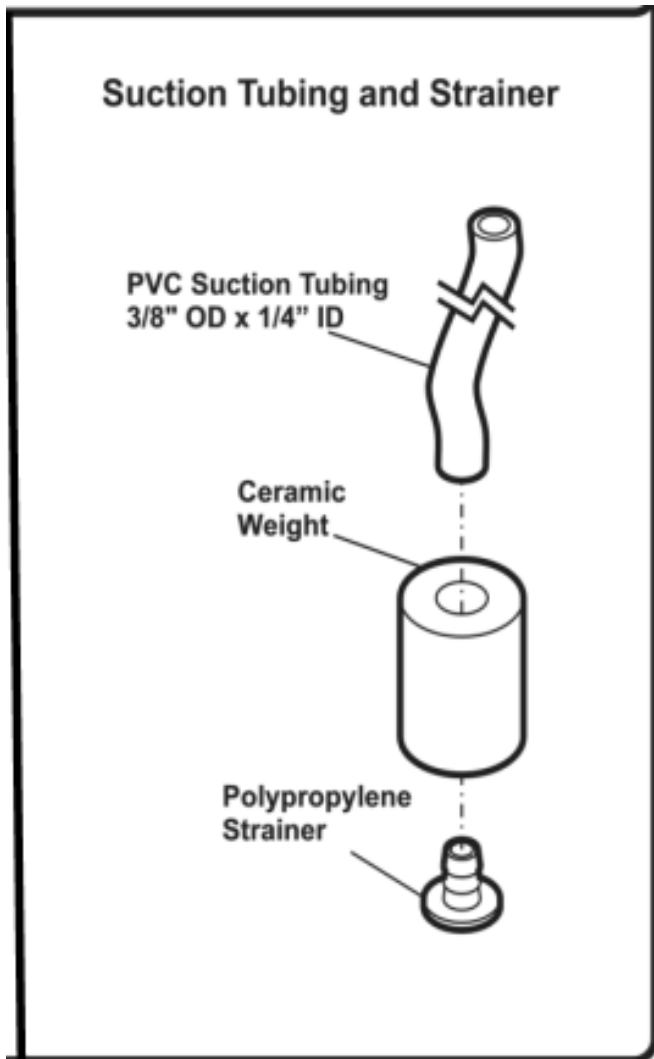

## 2.4 Input Power Connections

	<b>WARNING!</b>
	<p>Electrocution hazard.</p> <p>Cord connected models are supplied with a grounding conductor and grounding-type attachment plug. To reduce risk of electric shock, be certain that it is connected only to a properly grounded, grounding-type receptacle. Disconnect electricity before removing the termination box cover.</p>

	Electrical connections and grounding (earthing) must conform to local wiring codes.
---	---

- Be certain to connect pump to proper supply voltage. Using incorrect voltage will damage pump and may result in injury. Voltage requirement is printed on pump serial label.
- Input power range is 96VAC to 264VAC 50/60 Hz.
- Voltage Selection is automatically detected and adjusted by power supply. No mechanical switch necessary.
- Use voltage your power cord is rated for.
- Cord connected models are supplied with a ground wire conductor and a grounding type attachment plug (power cord). To reduce risk of electric shock, be certain that power cord is connected only to a properly grounded, grounding type receptacle.
- Never strap control (input / output) cables and power cables together.
- Power Interruption: This pump has an auto-restart feature which will restore pump to operating state it was in when power was lost.

	When in doubt regarding your electrical installation, contact a licensed electrician.
---	---

Power cord installation to the pump:

- Due to regulations Amphenol power cord connection to the pump (see page 14) has been secured with Loctite 425 thread locking.
- If you have to open this connection, please use a tool, required max torque is 0.5Nm (4 in.-lbs).
- When installing the cord insert the Amphenol connector plug into the Amphenol power connector on pump back side, notice the pin assignment in the connector, see page 14.
- Rotate the connector nut in the cable to secure connection tightness, use Loctite 425 locking.

TERMINATION BOX COVER

POWER CORD OPTIONS

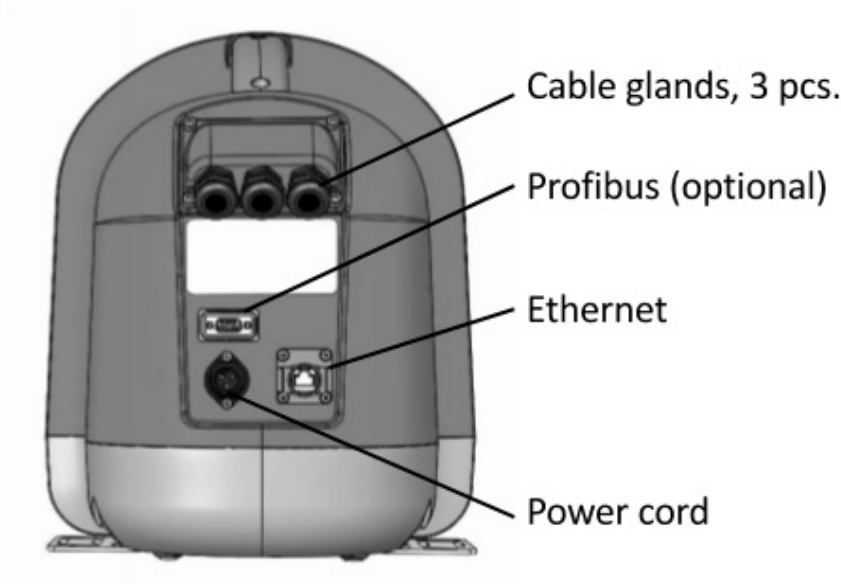

Cable and conduit connectors included

QTY.	DESCRIPTION
3	A M20 CABLE GLAND, ACCEPTABLE CABLE DIAMETER FROM 7 TO 13 MM
1	B POWER CORD CONNECTOR PWF-03PMMS-SC7001
1	C ETHERNET CONNECTOR RJ45
1	D PROFIBUS CONNECTOR (IN FUTURE OPTION)

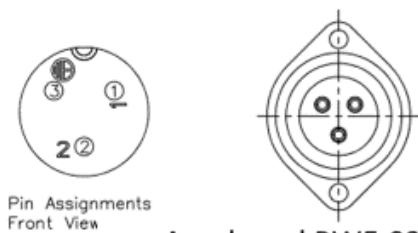

Amphenol Power Cord Connection ,  
field installation

Amphenol PWF-03PMMS SC7001  
connection in pump

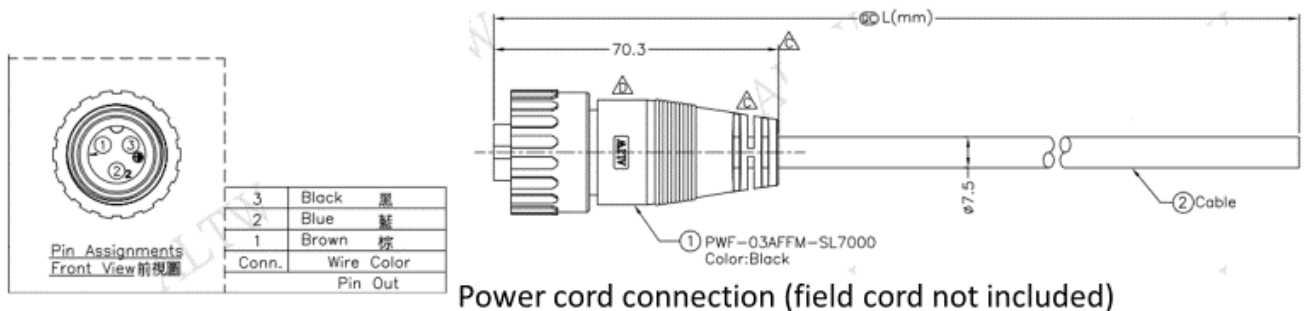

## 2.5 WIRING TERMINALS AND I/O SCHEMATICS

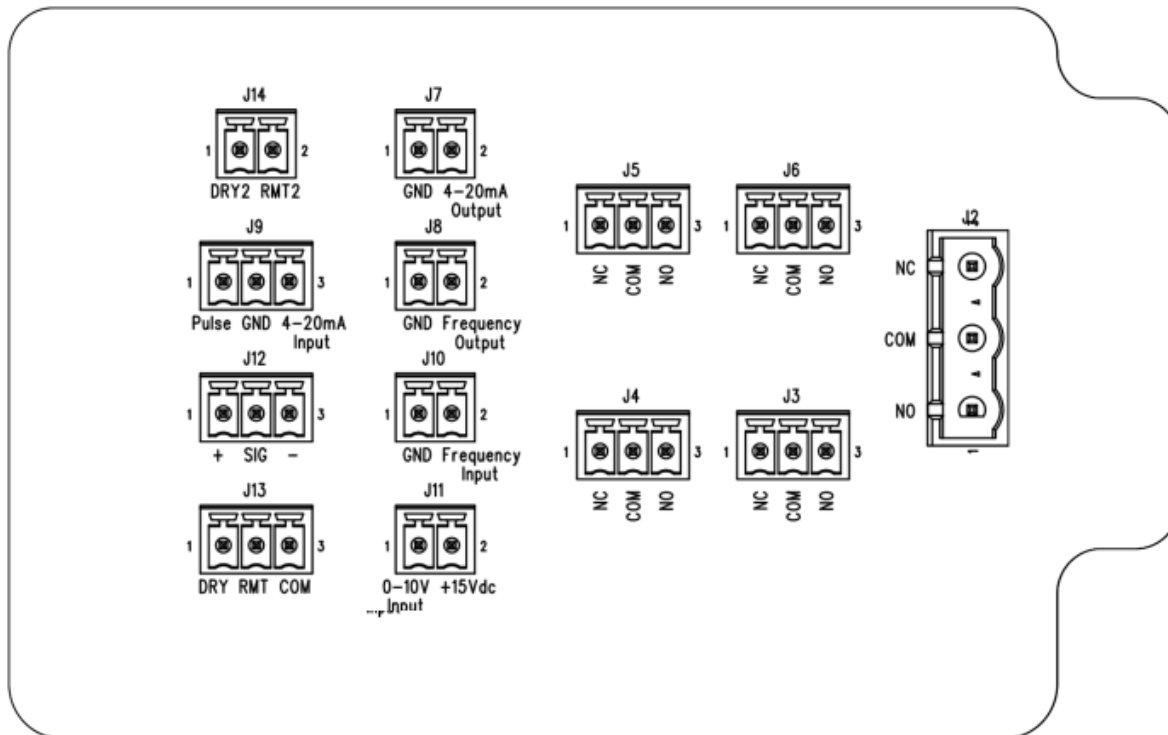

Connector box layout

FUNCTION	TERMINAL	PIN#	PIN NAME	RATING	ELECTRICAL SP.	
Input: 4-20 mA	J9	3	4-20mA input	(+) positive	120 Ohm impedance, non-powered loop	
		2	GND	(-) negative		
Input: Pulse	J9	1	Pulse	(+) positive	high: 2 to 30 VDC low: < 0,7 VDC Rising edge triggered	
		2	GND	(-) negative		
Input: Frequency, AC sine wave, TTL, CMOS	J10	2	Frequency input	(+) positive	0-1000 Hz high: 2 to 30 VDC low: < 0,7 VDC	
		1	GND	(-) negative		
Input: 0-10V DC	J11	1	0-10V input	(+) positive	Max load 50 mA	
		2	+15VDC	(+) positive		
	J9	2	GND	(-) negative		
Input: FVS System	J12	2	SIG	(+) positive	SIG high: 2 to 30 VDC SIG low: < 0,7 VDC	
		1	+	(+) positive		+5V
		3	-	(-) negative		GND
Input: Remote 1	J13	2	RMT	(+) positive	RMT high: 2 to 30 VDC RMT low: < 0,7 VDC	
		1	DRY	(+) positive		5 VDC / 1kOhm
		3	COM	(-) negative		GND
Input: Remote 2	J14	2	RMT2	(+) positive	RMT2 high: 2 to 30 VDC RMT2 low: < 0,7 VDC	
		1	DRY2	(+) positive		5 VDC / 1kOhm
Output: 4-20 mA	J7	2	4-20mA output	(+) positive	900 Ohm load max.	
		1	GND	(-) negative		
Output: Frequency	J8	2	Frequency output	(+) positive	open collector 0-1000 Hz 50% duty cycle	
		1	GND	(-) negative		
Output: Relay, 6 Amp	J2	1	NO	normally open	Form C 6 Amp max at 250 VAC, 2 Amp max at 24 VDC	
		2	COM	common		
		3	NC	normally closed		
Output: Contact Closure 1	J3	1	NC	normally closed	Form C 0,5 Amp max at 125 VAC, 2 Amp max at 30 VDC	
		2	COM	common		
		3	NO	normally open		
Output: Contact Closure 2	J4	1	NC	normally closed	Form C 0,5 Amp max at 125 VAC, 2 Amp max at 30 VDC	
		2	COM	common		
		3	NO	normally open		
Output: Contact Closure 3	J5	1	NC	normally closed	Form C 0,5 Amp max at 125 VAC, 2 Amp max at 30 VDC	
		2	COM	common		
		3	NO	normally open		
Output: Contact Closure 4	J6	1	NC	normally closed	Form C 0,5 Amp max at 125 VAC, 2 Amp max at 30 VDC	
		2	COM	common		
		3	NO	normally open		

### Connector specifications

### 3 How To Operate FXM

#### FXM Control Panel – Button Operation

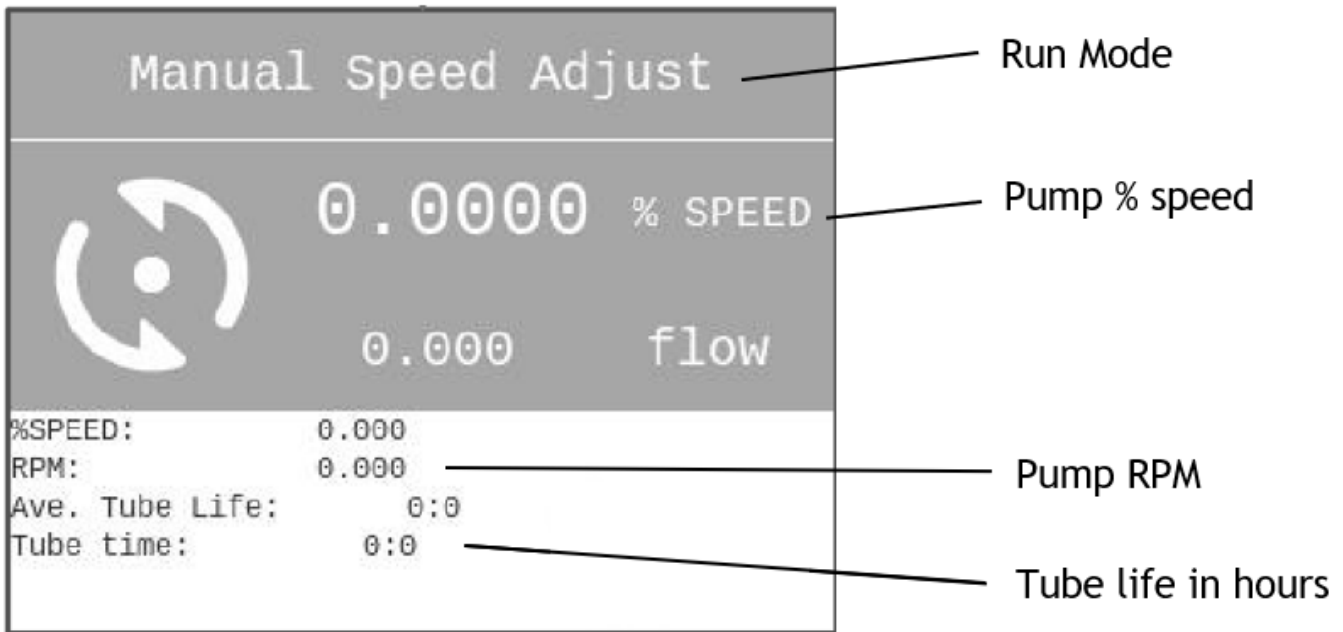
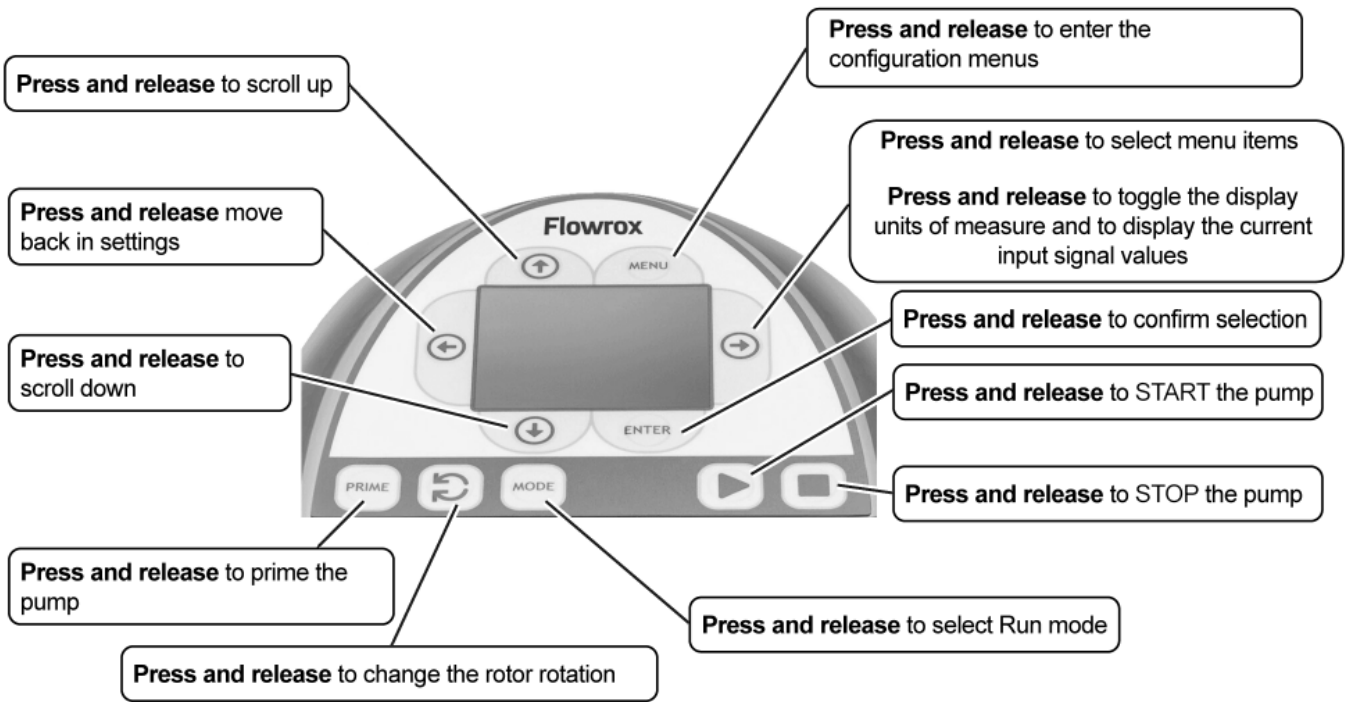

A sample of pump displays showing items on main display.



### 3.1 Menu Navigation

Use MENU button to enter menu for setting up pump.

Use UP or DOWN arrows to navigate through menu.

Active option appears on pump display in inverse text.

Arrow symbol signifies top of a menu tree. This means you can go further within menu.

Within Menu of pump, each screen you enter will have a title located along top. This will display the menu that is currently active, or this will be the setting you are configuring.

To back out of menu, select ← **Back** line located at end of list. Then press ENTER button. This will take you back one level.

When menu list extends above or below height of display, a scroll bar will appear on left side. Press DOWN arrow to scroll down to end of list to see a list of all available options.

Scroll bar example:

While making a selection where only one choice is allowed, you will see a radio button.

Radio button example:



Black tick shows item is selected



Outline with no tick means item is not selected

In a screen where you are making changes, you will see the mark **OK** located at bottom of list. You must select **OK** in order to leave screen (whether you made a change or not). Selecting **OK** will take you back to parent level.

When inputting a numerical value, use UP or DOWN arrow to scroll through 0 - 9. To move over to next digit use RIGHT arrow. If you pass your desired digit, you can continuously press RIGHT arrow until you scroll reach to your desired digit.

Numeric value example: **0000**

Sample screen shots

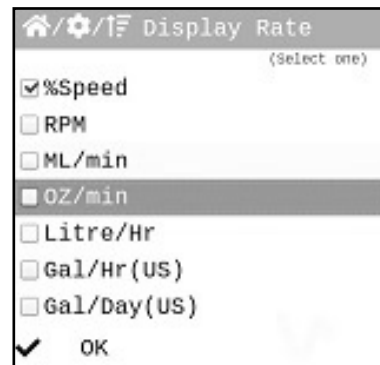
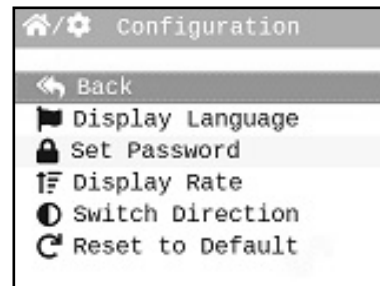
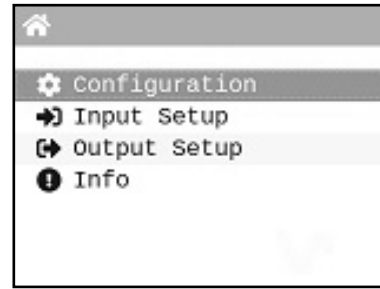

### 3.2 Configuration Menu

Below is menu structure for Configuration screens.

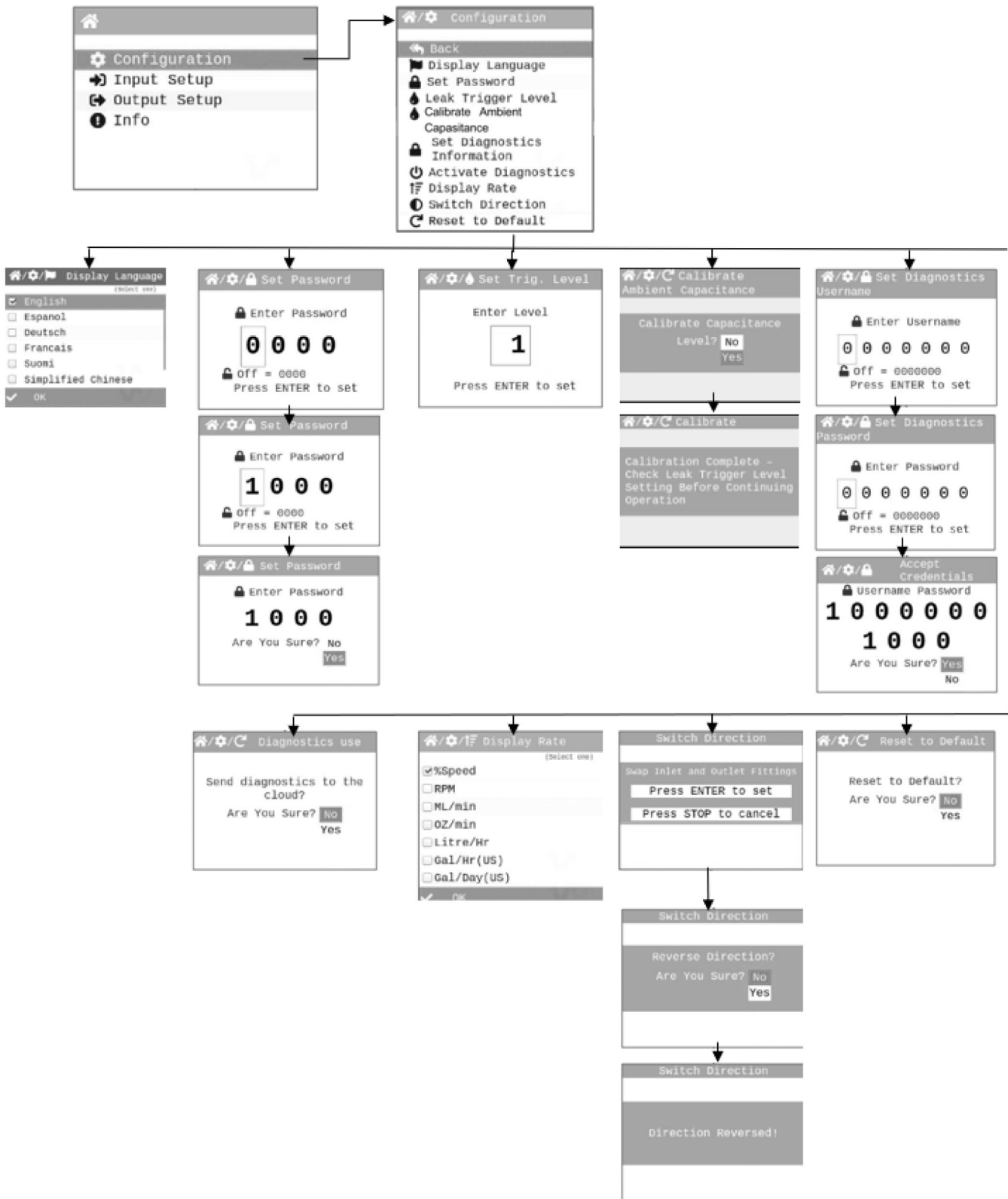

## Language Selection

Press MENU button to enter menu structure for setting up pump.

Select Configuration and Press ENTER button.

Select Display Language and Press ENTER button.

Select your desired language, then Press ENTER.

Select OK at bottom of list to confirm your selection. Press ENTER button.

Select ←Back on following screens to move back up to desired menu location.



## Set Password

Press MENU button to enter menu structure for setting up pump.

Select Configuration and Press ENTER button.

Select Set Password and Press ENTER button.

Set your desired number, then Press ENTER.

Note: Default is 0000.

Select Yes at bottom of list to confirm your selection. Press ENTER button.

Select ←Back on following screens to move back up to desired menu location.

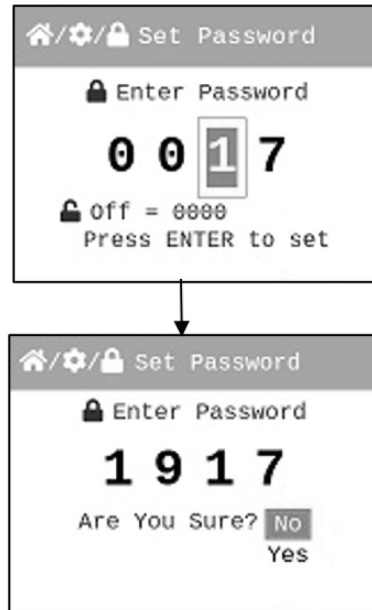

## Set Trigger Level

The FXM is equipped with a non-contact Tube Leak Detection (TLD) System which is designed to stop pump and provide an output alarm (see Output menu) in the event pump tube should rupture and chemical enters pump head. System is capable of detecting presence of a large number of chemicals including Sodium Hypochlorite (Chlorine), Hydrochloric (muriatic) Acid, Sodium Hydroxide, and many others. System will not be triggered by water (rain, condensation, etc.) or silicone oil (roller and tubing lubricant).

If system has detected chemical, pump tube must be replaced and pump head and roller assembly must be thoroughly cleaned. Failure to clean the roller assembly will void warranty.

If TLD alarm occurs, pump will stop, close an alarm output (if configured), and screen will flash TLD with an alarm icon.

Leakage Trigger Level setting:

Press MENU button to enter menu structure for setting up pump.

Select Configuration and Press ENTER button.

Select Set Trig. level and Press ENTER button.

Setting scale is 1-40. Set your desired number for Leakage Trigger setting, then Press ENTER. Factory setting is 12.

Select ←Back on following screens to move back up to desired menu location

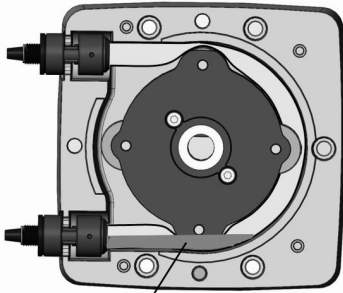

CHEMICAL FROM TUBE LEAK

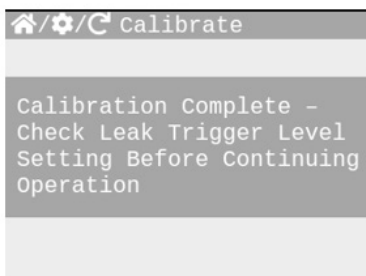
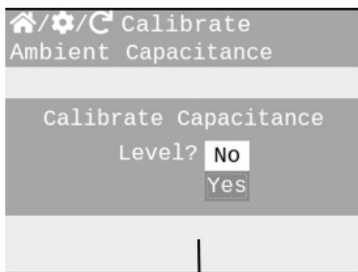
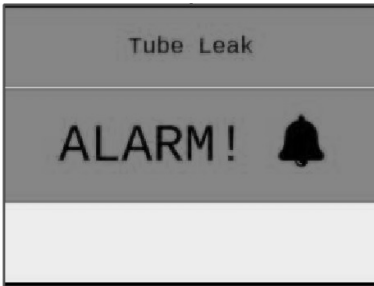

## Capacitance calibration

Tube Leak Detection (TLD) operation is based on capacity measurement at pump head. Once the ambient (base) capacitance is set by the calibration feature, that value is the 0 point in the scale and then there is a 1-40 trigger level setting that spreads the sensing range across those settings. The default setting above the base capacitance is [12]. Depending on how capacitive the fluid is this can be raised or lowered to tune the trigger sensitivity.

Examples when Ambient Capacitance should be calibrated:

1. Changes to the pump head or tube configuration.
2. Changes in the application installation location or conditions.

User Selects 'Yes' and presses [ENTER] to calibrate and the pump responds by reading the capacitance readings from the sensor. Once that level is read (e.g. 100ms) the pump will assign the base capacitance level as this value [+ ] 30ms to avoid false trigger levels. This level is set as the baseline capacitance.

**NOTICE: Check Set Trigger Level after calibration.**

**NOTICE: It is recommended to ensure proper leak triggering that the sensor be tested with a small amount of actual process chemical. This will help with fine tuning the trigger sensitivity. All safety precautions and proper personal protection equipment should be used when working with corrosive fluids.**

## Set Diagnostics Username

Press MENU button to enter menu structure for setting up pump.

Select **Configuration** and Press ENTER button.

Select **Set Diagnostics Information** and Press ENTER button.

Set your desired username number, then Press ENTER.

**Note:** Off is 0000000.

Set your desired password number, then Press ENTER.

**Note:** Off is 0000000

Select **Yes** at bottom of list to confirm your selection. Press ENTER button.

Select ←Back on following screens to move back up to desired menu location.

**NOTE: For features in Set Diagnostics Username and Diagnostics Use, please contact Valmet Flow Control Oy**

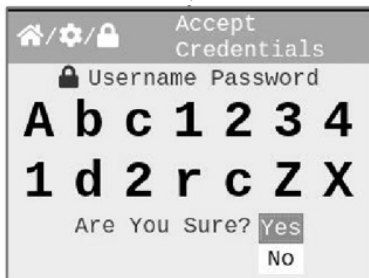
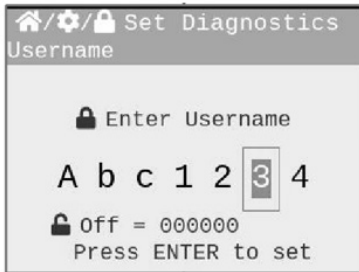

### Diagnostics Use

Press MENU button to enter menu structure for setting up pump.

Select **Configuration** and Press ENTER button.

Select **Activate Diagnostics** and Press ENTER button.

Select **Yes** at bottom of list to confirm your selection. Press ENTER button.

Select ←Back on following screens to move back up to desired menu location.

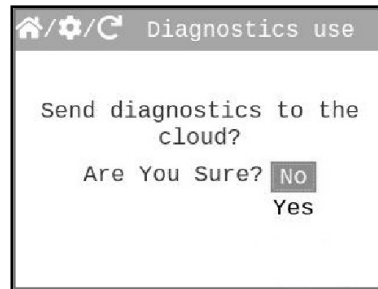

### Display Rate (Units of Measure)

By default, pump will display %Speed (motor speed) and RPM. It is recommended you select an additional **Display Rate**. After selecting another **Display Rate** (such as ML/min), pump will still display %Speed and RPM along with your selected Display Rate.

Press MENU button to enter menu structure for setting up pump.

Select **Configuration** and Press ENTER button.

Select **Display Rate** and Press ENTER button.

Select your desired Display Rate (unit of measure).

Note: %Speed and RPM will always be active and available to view when pump is in operation.

Select **OK** at bottom of list to confirm your selection and to return back to previous screen. Press ENTER button.

Select ←Back on following screens to move back up to desired menu location.

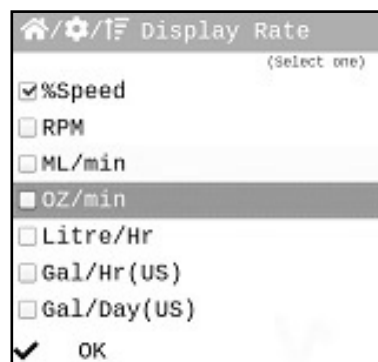

## Switch Direction

This will switch pump rotation direction.

Press **MENU** button to enter menu structure for setting up pump.

Select **Configuration** and Press **ENTER** button.

Select **Switch Direction** and Press **ENTER** button.

Select **No** or **Yes**, then **ENTER** button.

Select **←Back** on following screens to move back up to desired menu location.

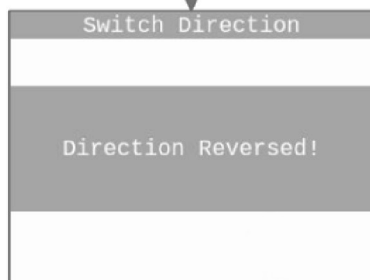
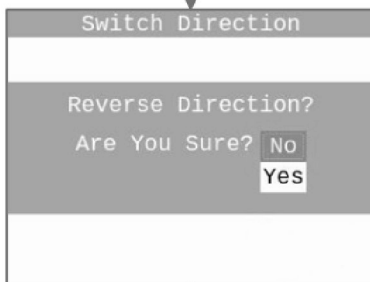
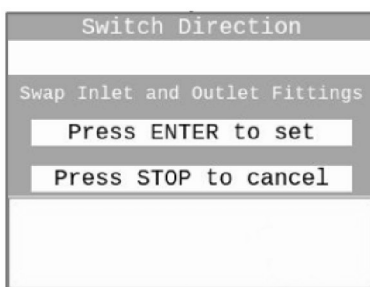

## Reset Factory Defaults

This will reset pump to factory defaults. This will restore pump to original configuration when it left the factory.

Press **MENU** button to enter menu structure for setting up pump.

Select **Configuration** and Press **ENTER** button.

Select **Reset to Default** and Press **ENTER** button.

Select **No** or **Yes**, then **ENTER** button.

Select **←Back** on following screens to move back up to desired menu location.

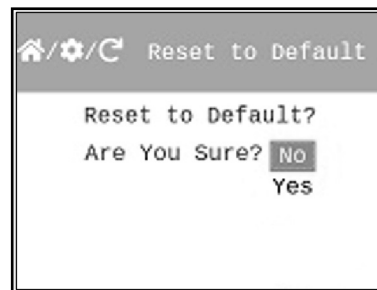

# 4 Input Setup

Below is the menu structure for the INPUT SETUP selection.

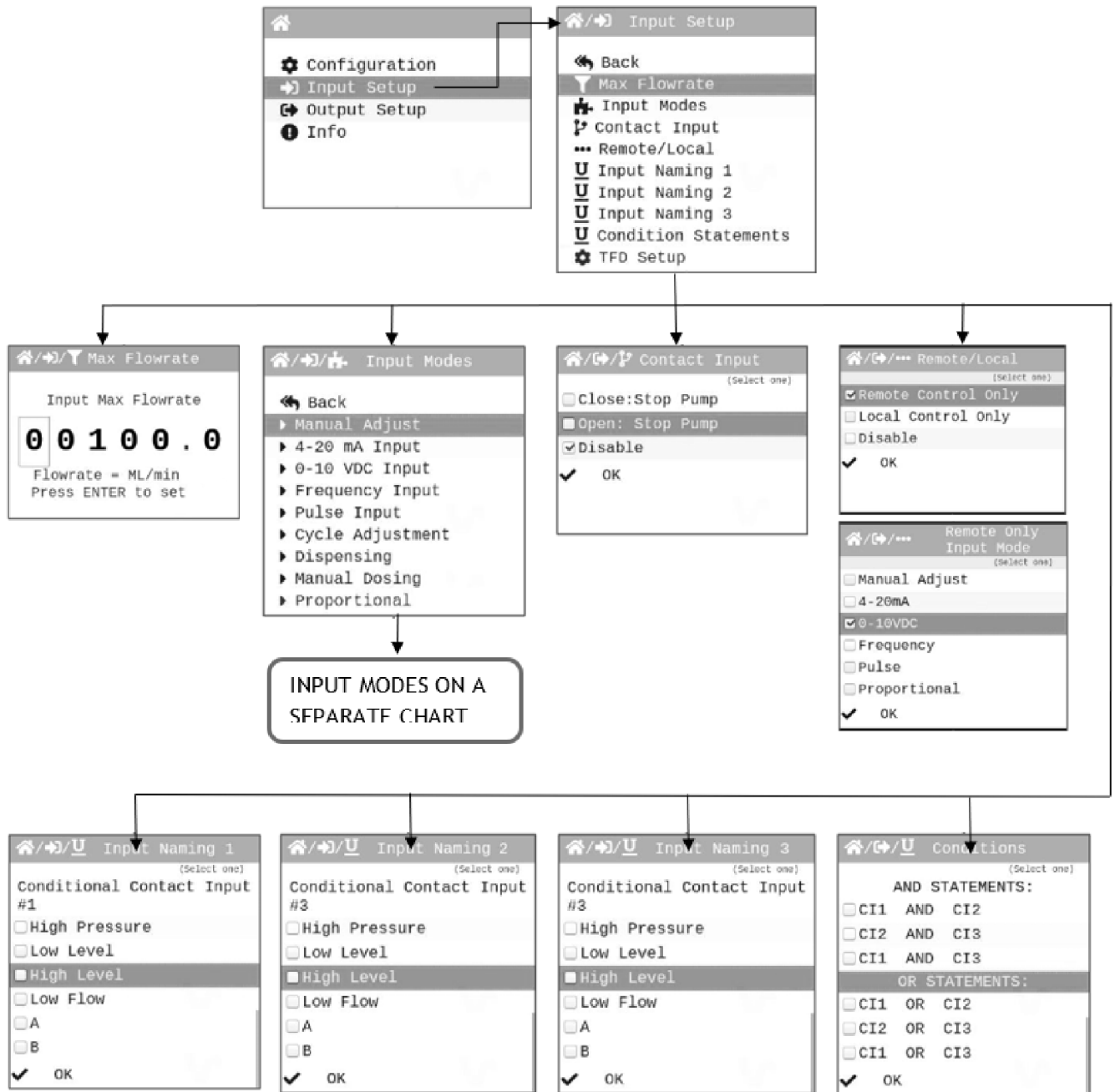

# INPUT MODE CHART

Home/Left/Right/Up/Down Input Modes

- Back
- Manual Adjust
- 4-20 mA Input
- 0-10 VDC Input
- Frequency Input
- Pulse Input
- Cycle Adjustment
- Dispensing
- Manual Dosing
- Proportional





## 4.1 MAX Flowrate (output calibration)

The MAX Flowrate value is equal to the pump's measured fluid output in millilitre per minute, at the 100% motor speed adjustment setting. The pump uses the MAX flow rate value to calculate motor speed for various operating functions and to display output values.

Each FLOWROX pump is calibrated at the factory and shipped with a calibrated pump tube assembly installed. The MAX flow rate value can be adjusted at any time. To achieve high accuracy, a field calibration under the actual operating conditions should be performed and the Max Flowrate value changed to reflect the calibrated amount. Multiply the **Max Flowrate** value by the percentage of error at your calibrated flow rate to obtain the new **Max Flowrate** value.

Select **Max Flowrate** and Press ENTER button.

Press UP or DOWN arrow to scroll through 0 - 9 on selected digit.

Press RIGHT arrow to scroll over to next digit to right. If you pass your desired digit, you can easily scroll back by continuously pressing RIGHT button.

Press ENTER to save changes.

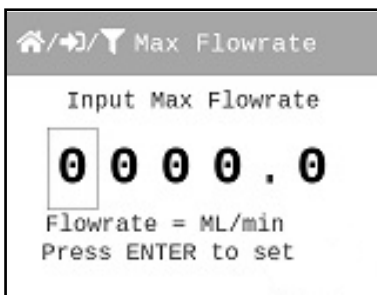

Select **<Back** on the main menu screen to exit the menu structure and enter the run mode.

Every pump tube assembly model number has a published maximum flow rate value which is based on laboratory tests pumping water at room temperature at 36" suction lift against 0 psi back pressure. Your actual output may vary due to fluid viscosity, fluid temperature, suction lift height, piping system layout, manufacturing tolerances and to a lesser degree, variations in system pressure and tubing wear.

To achieve high accuracy, the pump's output should be measured (calibrated), and the MAX Flowrate value (in millilitre per minute) updated.

Conditions that require calibration:

- At the initial pump start up.
- When a new tube assembly is installed. Run the pump with or without fluid for approximately 30 minutes prior to calibration.

- When the piping system configuration is changed.
- When the suction lift height is changed.
- Periodically during the life of the tube. Output variances are most noticeable prior to tube failure.

### To calculate the Max Flowrate:

To determine the amount of error at your output setting, divide the actual output amount by the indicated output. Then multiply the resulting percentage of error by the Max Flowrate value currently showing in the pump.

Example: If the pump display indicates the output is 170 ml/min but the actual measured output is 160 ml/min, calculate the percentage of error by:  $160/170 = 0.941$ . Multiply the **Max Flowrate** value by 0.941 and enter this new value.

## Manual Adjust (manual speed adjust)

Used to manually control speed of pump. Use up and down arrows to adjust the speed while the pump is running or set % (percent) Motor Speed in this menu.

Press SELECT RUN MODE button until **Manual Speed Adjust** is displayed in the top line of the display.

To configure the pump output speed, navigate to **Manual Speed Adjust** menu by pressing MENU button, then selecting Input Setup, Input Modes, and then **Manual Adjust**.

Press UP or DOWN arrow to scroll through 0 - 9 on selected digit.

Press RIGHT arrow to scroll over to next digit to right. If you pass your desired digit, you can easily scroll back by continuously pressing RIGHT button.

Press ENTER to save changes.

To navigate back out of the menu structure select ← Back at bottom of every screen menu until you see Run Mode screen displayed.

**Tip! This feature can be combined with Contact Input feature to allow for remote Start and Stop of pump. Can be used with PLC, foot pedal, push button, or other external controls.**

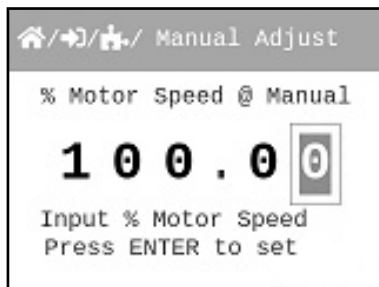

## 4 – 20 mA Input

Used to remotely control pump with an incoming 4-20 mA signal.

Default settings:

4 mA = 0% motor speed

20 mA = 100% motor speed

Press SELECT RUN MODE button until **4 – 20 mA Input** is displayed in the top line of the display.

To configure the pump, navigate to **4 – 20 mA Input** menu by pressing MENU button, then selecting Input Setup, Input Modes, and then **2 – 20 mA Input**.

Press UP or DOWN arrow to scroll through 0 – 9 on selected digit.

Press RIGHT arrow to scroll over to next digit to right. If

you pass your desired digit, you can easily scroll back by continuously pressing RIGHT button.

Press ENTER to save changes.

Continue this process until all four screens have been configured.

To navigate back out of the menu structure you must select ← Back at bottom of every screen menu until you see Run Mode screen displayed.

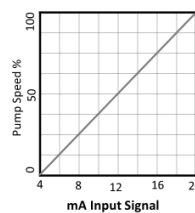
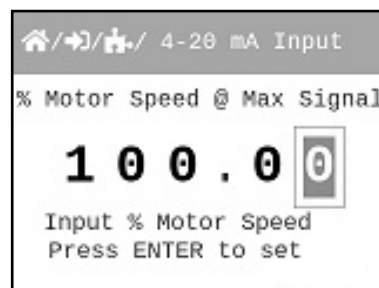
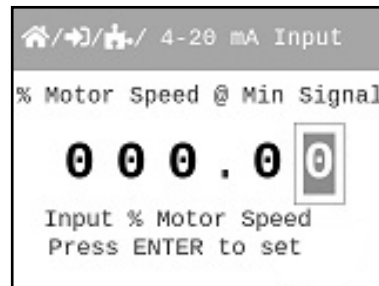
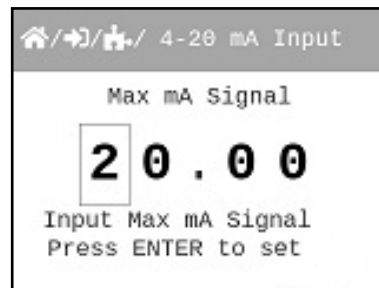
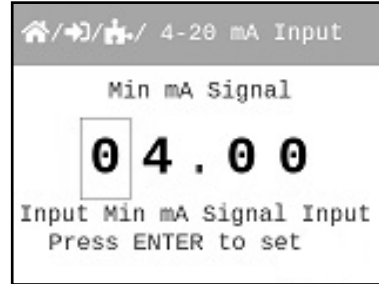

Example A:  
4mA = 0% Pump Output  
20mA = 100% Pump Output

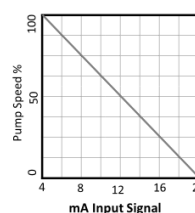

Example B:  
4mA = 100% Pump Output  
20mA = 0% Pump Output

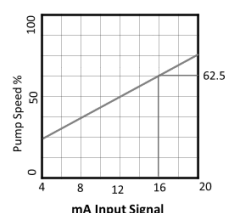

Example C:  
4mA = 25% Pump Output  
16mA = 62.5% Pump Output

## 0 – 10 VDC Input (Volt DC)

Used to remotely control pump with an incoming 0-10 VDC signal.

Default settings:

0 VDC = 0% motor speed

10 VDC = 100% motor speed

Press SELECT RUN MODE button until **0 – 10 VDC Input** is displayed in the top line of the display.

To configure the pump, navigate to **0 – 10 VDC Input** menu by pressing MENU button, then selecting Input Setup, Input Modes, and then **0 – 10 VDC Input**.

Press UP or DOWN arrow to scroll through 0 – 9 on selected digit.

Press RIGHT arrow to scroll over to next digit to right. If you pass your desired digit, you can easily scroll back by continuously pressing RIGHT button.

Press ENTER to save changes.

Continue this process until all four screens have been configured.

To navigate back out of the menu structure you must navigate back out of menu structure. To do this you must select < Back at bottom of every screen menu until you see Run Mode screen displayed.

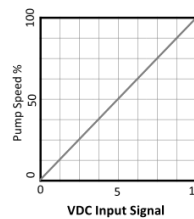
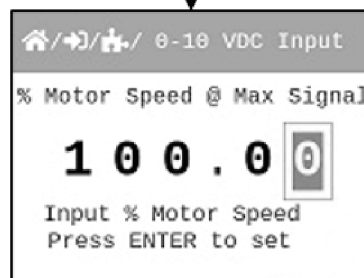
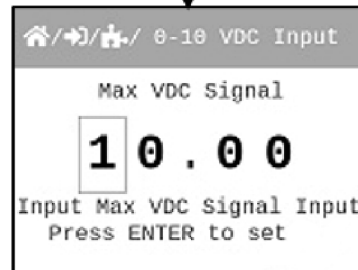
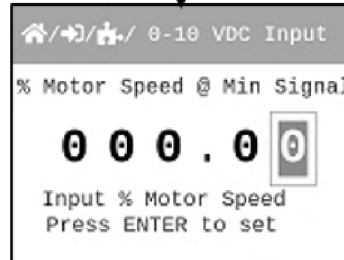
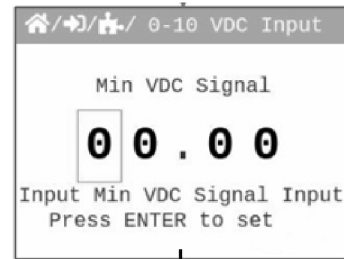

Example A:  
0 VDC = 0% Pump Output  
10 VDC = 100% Pump Output

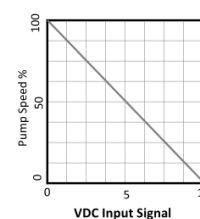

Example B:  
0 VDC = 100% Pump Output  
10 VDC = 0% Pump Output

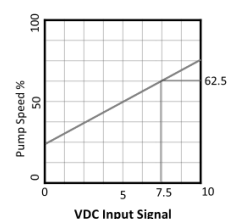

Example C:  
0 VDC = 25% Pump Output  
7.5 VDC = 62.5% Pump Output

## Frequency Input (Hz)

Used to remotely control pump with an incoming high speed frequency signal. Typically used with flow meters or other external devices.

Default settings:

0 Frequency (Hz) = 0% motor speed

1000 Frequency (Hz) = 100% motor speed

Press SELECT RUN MODE button until **Frequency Input** is displayed in the top line of the display.

To configure the pump, navigate to **Frequency Input** menu by pressing MENU button, then selecting Input Setup, Input Modes, and then Frequency Input.

Press UP or DOWN arrow to scroll through 0 – 9 on selected digit.

Press RIGHT arrow to scroll over to next digit to right. If you pass your desired digit, you can easily scroll back by continuously pressing RIGHT button.

Press ENTER to save changes.

Continue this process until all four screens have been configured.

To navigate back out of the menu structure you must navigate back out of menu structure. To do this you must select ←Back at bottom of every screen menu until you see Run Mode screen displayed.

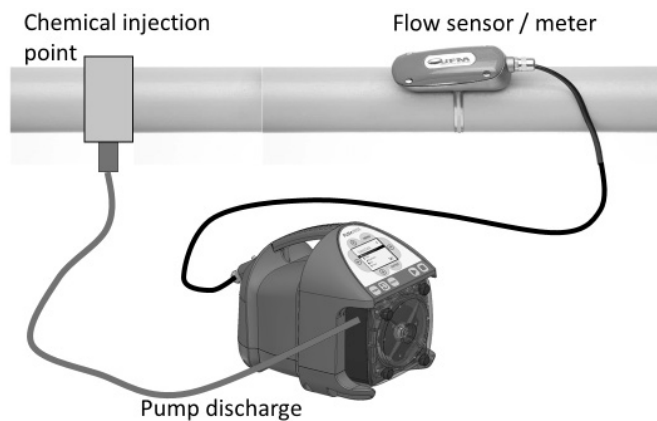
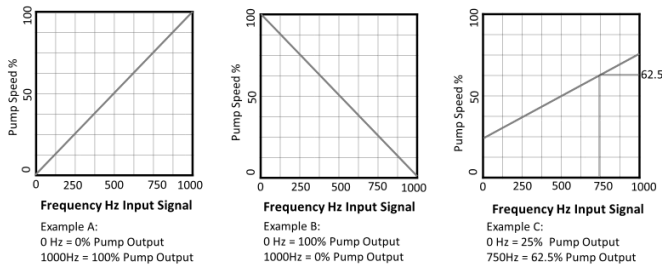

## Pulse Batch Input (low speed pulse)

Used to remotely control pump with an incoming pulse signal. Can be used with an external foot pedal, a water meter, a PLC, contact closure, or other low speed pulse devices.

Default settings:

1 Pulse = 100% motor speed for 2.5 seconds

Press SELECT RUN MODE button until **Pulse Batch** is displayed in the top line of the display.

To configure the pump, navigate to **Pulse Batch** menu by pressing MENU button, then selecting Input Setup, Input Modes, and then **Pulse Batch**.

Press UP or DOWN arrow to scroll through 0 – 9 on selected digit.

Press RIGHT arrow to scroll over to next digit to right. If you pass your desired digit, you can easily scroll back by continuously pressing RIGHT button.

Press ENTER to save changes.

Continue this process until all four screens have been configured.

To navigate back out of the menu structure, you must select ← Back at bottom of every screen menu until you see Run Mode screen displayed.

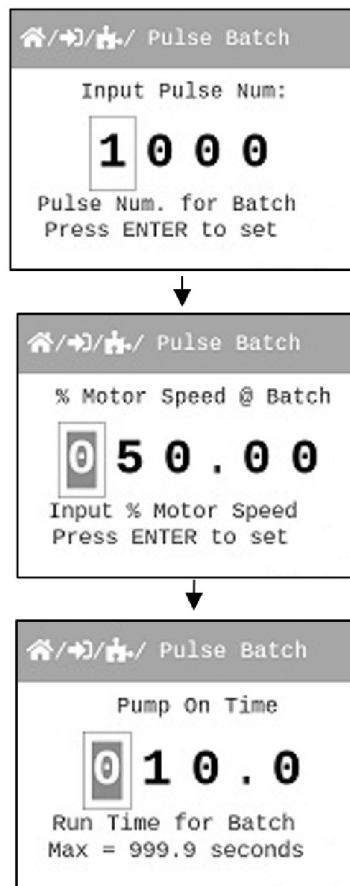

## Manual Cycle Adjust (repeating cycle timer)

Used to run at a pre-selected motor speed for a specified run time. This cycle will repeat itself using a repeating cycle timer.

Default settings:

100% motor speed for 1.5 seconds

Repeating cycle timer = 4 seconds

Press SELECT RUN MODE button until Manual Cycle Adjust is displayed in the top line of the display.

To configure the pump, navigate to Manual Cycle Adjustment menu by pressing MENU button, then selecting Input Setup, Input Modes, and then Cycle Adjustment.

Press UP or DOWN arrow to scroll through 0 – 9 on selected digit.

Press RIGHT arrow to scroll over to next digit to right. If you pass your desired digit, you can easily scroll back by continuously pressing RIGHT button.

Press ENTER to save changes.

Continue this process until all three screens have been configured.

To navigate back out of the menu structure you must navigate back out of menu structure. To do this you must select ←Back at bottom of every screen menu until you see Run Mode screen displayed.

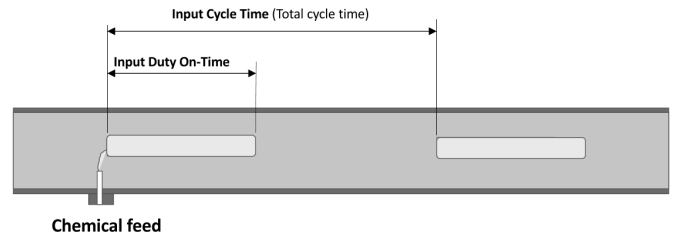
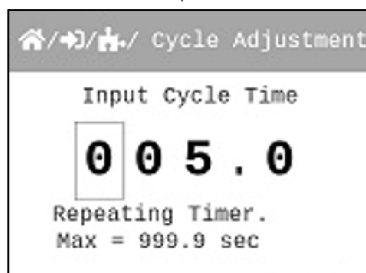
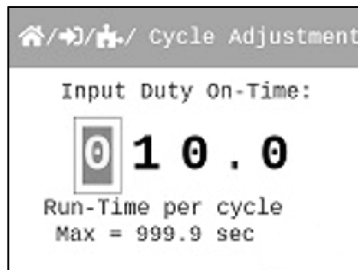
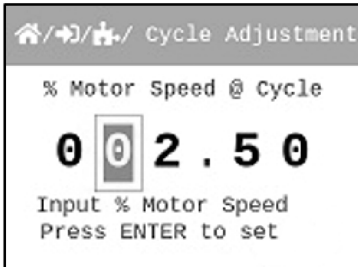

Graphical representation of Manual Cycle Adjust injection characteristics.

**Note:** Your chemical or solution is mixed in fluid. This image is only illustrating feed characteristics.

## Dispensing

Configure any dispensing amount or sample size and pump will repeat it on command by pressing START button. Great for accurate single shot dispensing of a pre-configured volume.

Default settings:

1000 milliliters

50% pump speed

Press SELECT RUN MODE button until **Dispensing** is displayed in the top line of the display.

To configure the pump, navigate to **Dispensing** menu by pressing MENU button, then selecting Input Setup, Input Modes, and then **Dispensing**.

Press UP or DOWN arrow to scroll through 0 – 9 on selected digit.

Press RIGHT arrow to scroll over to next digit to right. If you pass your desired digit, you can easily scroll back by continuously pressing RIGHT button.

Press ENTER to save changes.

Continue this process until all two screens have been configured.

To navigate back out of the menu structure, you must select ← Back at bottom of every screen menu until you see Run Mode screen displayed.

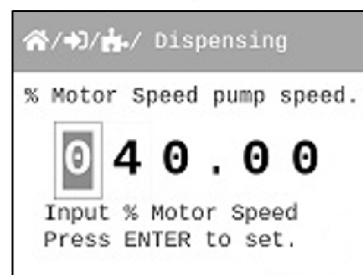

## Manual Dosing

Used to configure Parts Per Million dosing to a system. This method can be used if treated fluid volume is a fixed amount (in Liters Per Minute). If treated fluid volume is variable (continuous change), then use of a flow meter is recommended along with pumps Proportional Mode (next Run Mode).

Default settings:

12.5% dose solution concentration

1.25 dose solution Specific Gravity

10 l/min (liters per minute) fluid volume to be treated

1.0 Parts Per Million to dose

Press SELECT RUN MODE button until **Manual Dosing** is displayed in the top line of the display.

To configure the pump, navigate to **Manual Dosing** menu by pressing MENU button, then selecting Input Setup, Input Modes, and then **Manual Dosing**.

Press UP or DOWN arrow to scroll through 0 – 9 on selected digit.

Press RIGHT arrow to scroll over to next digit to right. If you pass your desired digit, you can easily scroll back by continuously pressing RIGHT button.

Press ENTER to save changes.

Continue this process until all four screens have been configured.

To navigate back out of the menu structure, you must select ← Back at bottom of every screen menu until you see Run Mode screen displayed.

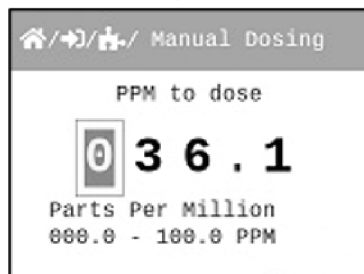
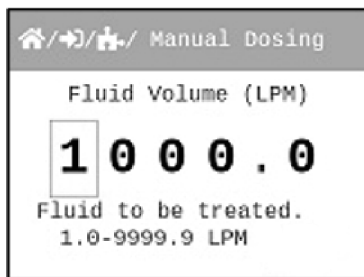
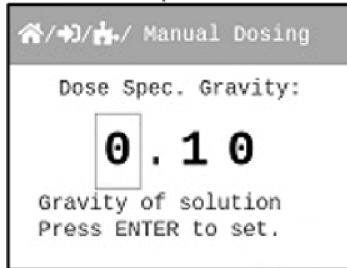
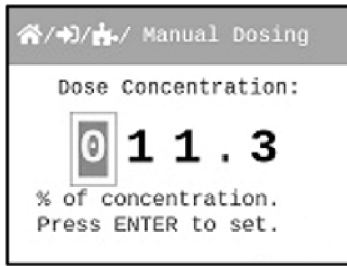

To configure the pump, navigate to **Proportional Dosing** menu by pressing MENU button, then selecting Input Setup, Input Modes, and then **Proportional**.

Press UP or DOWN arrow to scroll through 0 – 9 on selected digit.

Press RIGHT arrow to scroll over to next digit to right. If you pass your desired digit, you can easily scroll back by continuously pressing RIGHT button.

Press ENTER to save the changes.

Continue this process until all four screens have been configured.

To navigate back out of the menu structure, you must select ← Back at bottom of every screen menu until you see Run Mode screen displayed.

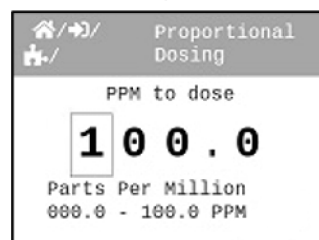
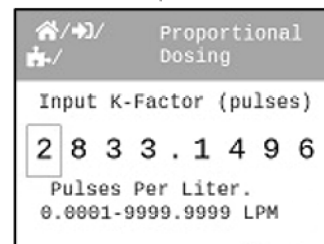
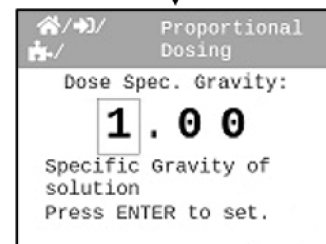
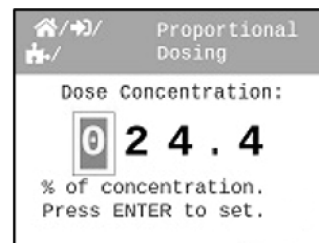

## Proportional Dosing

Used to configure proportional Parts Per Million dosing to a system. This method of proportional dosing is based off input pump is receiving from an external flow meter. Flow meter must have a pulse output. You will need to refer to flow meter instruction manual to obtain K-factor for flow meter.

Default settings:

12.5% dose solution concentration

1.25 dose solution Specific Gravity

5.0 K-factor (Pulses Per Litre), see flow meter instruction manual

1.0 Parts Per Million to dose

Press SELECT RUN MODE button until **Proportional Dosing** is displayed in the top line of the display.

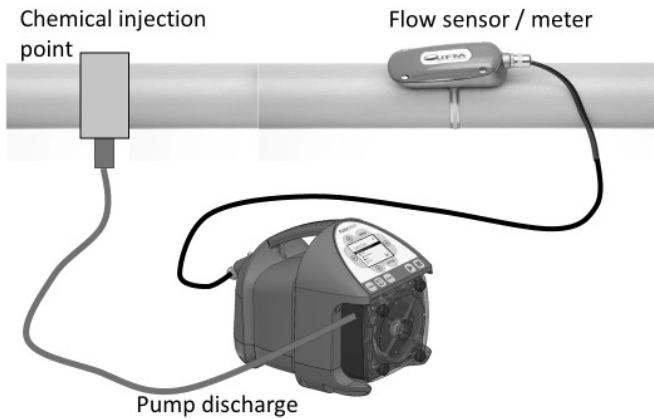

When Contact Input is enabled, the word Remote will be displayed on lower left side of screen at all times

**\*NOTE: YOU MUST SET THE “CC1 OR CC2” FORMAT UNDER THE CONDITIONAL LOGIC SECTION 4.5 TO ENABLE INPUT CONTROL.**

Signal stopped pump:

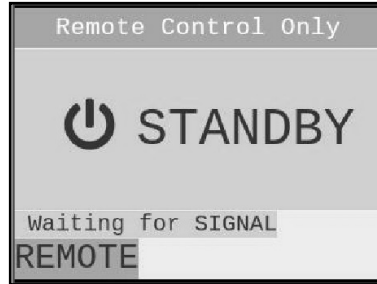

Signal started pump:

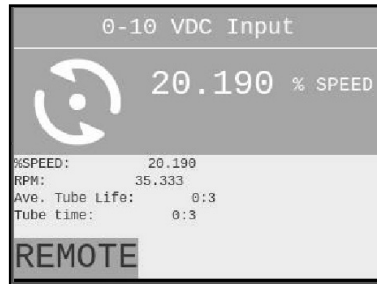

## 4.2 Contact Input

Used to remotely start and stop pump using a close=stop or open=stop signal. If pump should start on an open, then select “Close: Stop Pump” option. Can be used with an external foot pedal, a PLC, contact closure, or other similar external devices.

Default settings: Disable

CC Input Range: 6 – 30 VDC OR

Dry Contact Closure (no voltage required)

Navigate to **Contact Input** menu by MENU button, then selecting Input Setup, and then **Contact Input**.

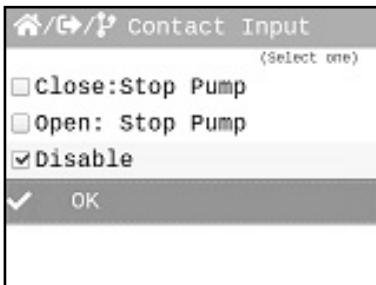

Press UP or DOWN arrow to scroll through your options. Press ENTER to make a selection. You should then notice radio button (square box) is now filled in next to your selection.

Press DOWN arrow to scroll down to OK selection. Then press ENTER.

To navigate back out of menus, select ←Back and press the ENTER button at bottom of every screen menu until you see Run Mode screen displayed.

**IMPORTANT:** If Contact Closure Input is enabled, pump will display STANDBY if pump is in Stop mode via the Contact Closure. Please use caution in this mode. Pump can Start at anytime. If you must perform maintenance to the pump, Press STOP button.

## 4.3 Remote/Local Control

The FXM can be configured for Remote control only, Local control only, or either (disabled).

When set for Remote control only, all touch pad buttons except the menu button are disabled. To completely lock out the menu, configure a password (see page 19, Set Password). If REMOTE ONLY is selected, the user is prompted to select an input operating mode which must then be used when operating the pump.

When set for LOCAL CONTROL only, all input signals including the remote start/stop are disabled. Note that the “Contact Closure Input” menu setting (section 4.3) is switched to “disabled” while **LOCAL CONTROL ONLY** is selected. This menu setting will return to the previous setting when **REMOTE CONTROL ONLY** or **DISABLED** is selected.



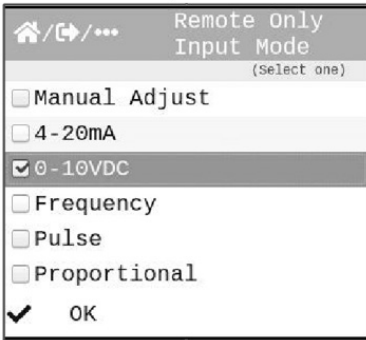
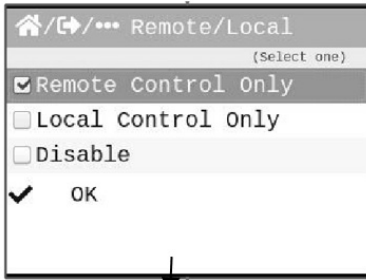

#### 4.4 Conditional Contact Input Naming

- Conditional Contact Inputs (CC) #1, #2, #3 and #4 can be named by selecting the factor from the Input listing.
- When contacts are closed or opened the Screen will Alarm and
- Indicate which input contact had a status change and show as an alarm condition.

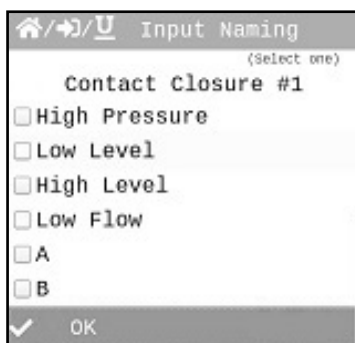
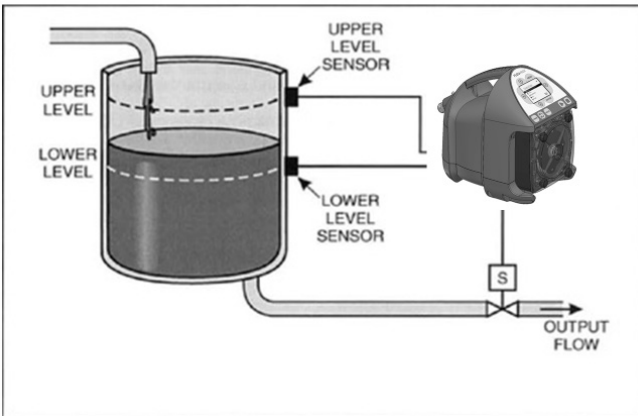

#### 4.5 Conditional Logic Control

- Conditional Contact Inputs can be used to operate the pump in much the same way as a simple program controller.
- All other alarm conditions must be satisfactory before these functions can run.
- AND statements are related to two inputs that must be satisfied for the pump to be allowed to run.
- OR statements are related to using either one input or another to tell the pump to run.

Example:

- Input 1 is a remote start/stop for the pump, “AND” Input 2 is an isolation valve with a limit switch, both the valve showing as open by the limit switch and the pump being told to run by the remote start/stop will then allow the pump to run.
- If either one of those conditions is not met, then the pump will not run.

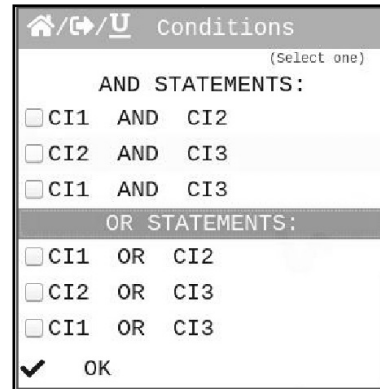

#### Pump Tube Timer

The FXM has a built in Pump Tube Timer. Timer starts when rotor is rotating and stops when rotor is idle. THE TUBE TIMER IS ALWAYS DISPLAYED ON THE MAIN SCREEN

Screen will display current Pump Tube Time in run-time hours:minutes.

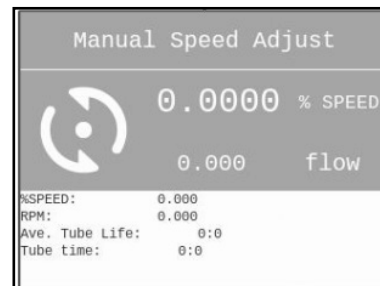

## 5 Output setup ( alarm relays )



Contact #1 shown only. Contact #2, and Contact #3 use the same menu items.

Below is menu structure for Output Setup screens.

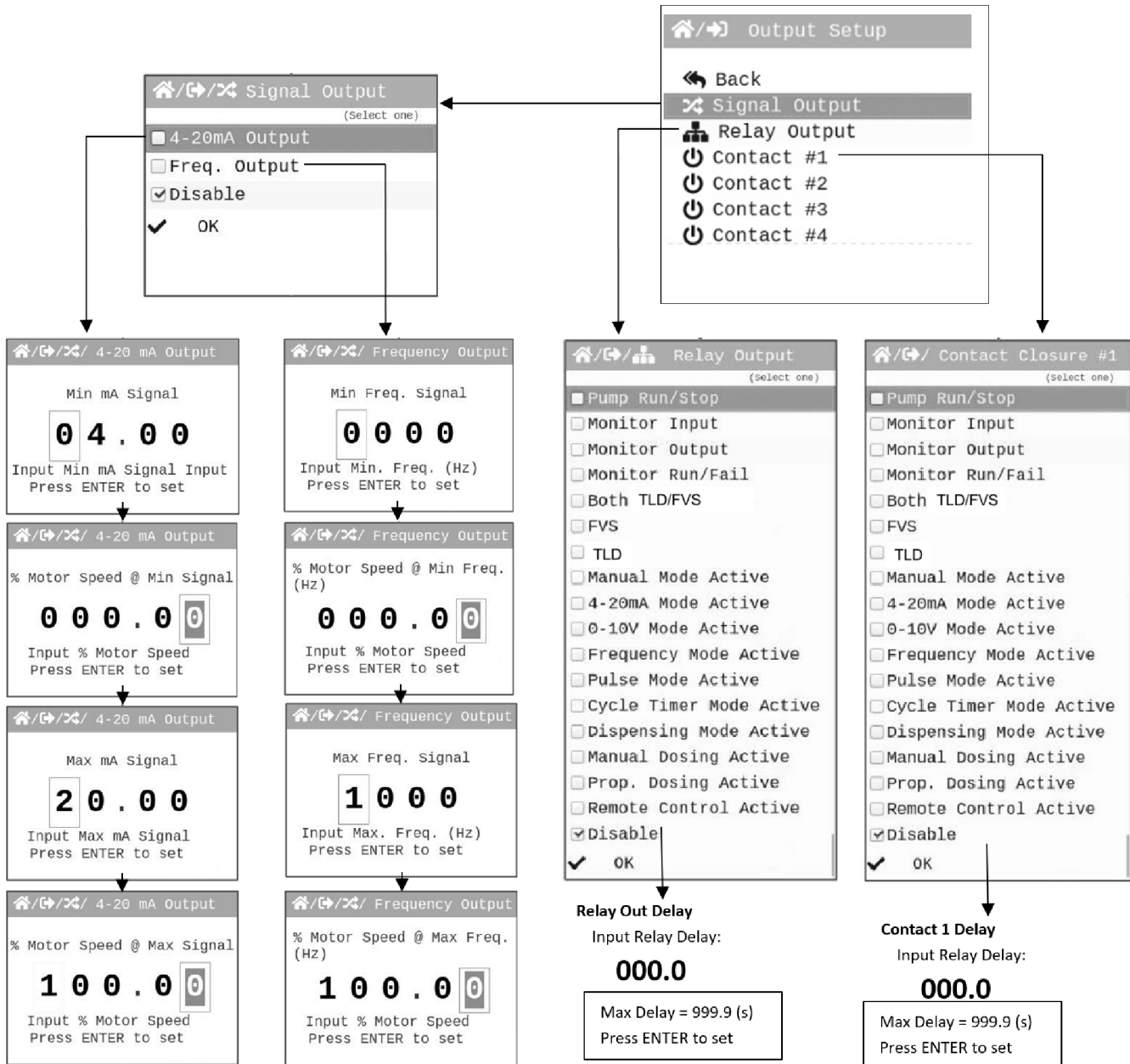

## Description of Relay and Contact Closure Output triggers

Selection	Contact energizes when
<b>Pump Run/Stop</b>	Motor turning (roller assembly is rotating).
<b>Monitor Input</b>	Incoming analog or digital signal is not received or is out of range.
<b>Monitor Output</b>	Outgoing analog or digital signal not transmitted or is out of range.
<b>Monitor Run/Fail</b>	Motor fails to respond to commands from the internal controller.
<b>Both TLD/FVS</b>	Either TLD or FVS system triggers.
<b>FVS</b>	After the programmed delay time, pulses are not received from flow sensor.
<b>TLD</b>	Tube leak is detected by sensors in the head.
<b>Active Mode</b>	The selected run mode is currently activated.
<b>Remote Active</b>	Energized when Remote only is activated.
<b>Reverse Alarm</b>	The motor revolution is reversed (turning clock-wise).
<b>General Error</b>	A motor overload or other internal error has occurred.
<b>Disable</b>	Output alarm contact is disabled.

Continue this process until all four screens have been configured.

To navigate back out of menu structure you must select ←OK at bottom of every screen menu until you see Run Mode screen displayed.

## 5.1 Signal Output

Sends a configurable 4 - 20 mA or frequency (Hz) signal to another pump or external device. This feature can be used to control other pumps (in sync / proportionally), data logging systems, and other external devices for plant automation.

Output Setup menu structure, see page 39.

Default settings: Disable

Navigate to **Signal Output** menu by pressing MENU button, then selecting Output Setup, and then **Signal Output**.

Select your desired Signal output using UP or DOWN arrows.



Press ENTER to configure output signal.

Press UP or DOWN arrow to scroll through 0 - 9 on selected digit.

Press RIGHT arrow to scroll over to next digit to right. If you pass your desired digit, you can easily scroll back by continuously pressing RIGHT button.

Press ENTER to save changes.

## 6 Pump Maintenance

	Always wear protective clothing, face shield, safety glasses and gloves when working on or near your metering pump. Additional precautions should be taken depending on solution being pumped. Refer to MSDS precautions from your solution supplier.
	Do not change the settings in the Maintenance Mode.

### 6.1 Routine Inspection and Maintenance

The pump requires very little maintenance. However, the pump and all accessories should be checked weekly. This is especially important when pumping aggressive chemicals. Inspect all components for signs of leaking, swelling, cracking, discoloration or corrosion. Replace worn or damaged components immediately.

Cracking, crazing, discoloration and the like during first week of operation are signs of severe chemical attack. If this occurs, immediately remove chemical from pump. Determine which parts are being attacked and replace them with parts that have been manufactured using more suitable materials.

### 6.2 How to Clean and Lubricate the Pump

When changing the pump tube assembly, the pump head chamber, roller assembly and pump head cover should be wiped free of any dirt and debris.

Although not necessary, 100% silicon lubrication may be used on the roller assembly and tube assembly.

The motor does not require maintenance or lubrication.

### 6.3 Reverse Rotor Rotation

The pump rotor can reverse rotation by pressing REVERSE ROTATION button.

In most applications, the tube will fail by developing a small leak in the outlet side (pressure side) of the tube assembly. By reversing the roller rotation, the wear point in the tube is moved to the opposite side to the pump tube assembly, increasing the life of the tube.

Reversing rotation, moves the outlet side (pressure side) to the opposite side of the tube assembly, greatly increasing the tube life.

Stop the pump before the tube failure occurs.

Disconnect power from the pump. Carefully purge any pressure in the discharge line of the pump. Disconnect the suction end tubing/piping and the discharge end tubing/piping from the pump head tubing.

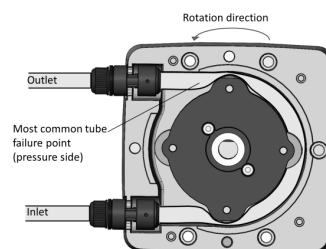



**IMPORTANT!** Change sides of the suction (inlet) and discharge (outlet) tubing/piping. There is no need to remove the Pump Head Cover.

Double check all connections before starting the pump

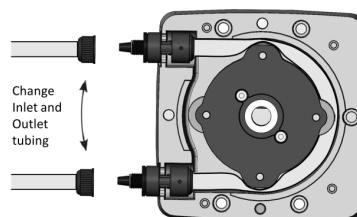
**NOTE:** The pump tube will form a natural U-shaped curve. Do not attempt to install the pump tube against the natural U-shape direction as damage to the tube can result.



## 6.4 Tube Replacement

	Prior to service, pump clean water through the pump and suction / discharge line to remove chemical.
	Always wear protective clothing, face shield, safety glasses and gloves when working on or near your metering pump. Additional precautions should be taken depending on solution being pumped. Refer to MSDS precautions from your solution supplier.

<b>CAUTION!</b>	
	Crushing hazard.  Use extreme caution when replacing pump tube. Be careful of your fingers and <b>DO NOT</b> place fingers near rollers.

In this mode, the pump rotor can rotate up to 6 revolutions per minute for your safety.

Maintenance Mode
Cover was removed, Pump Motor Speed = 6 RPM
Press <b>START</b> to run
Press <b>STOP</b> to stop

	Auto-restart feature is not available in the Maintenance mode.
--	--

Pull out suction side of **Tubing Assembly**.

Press **START** button. While rotor is rotating, pull out old **Tube Assembly**.

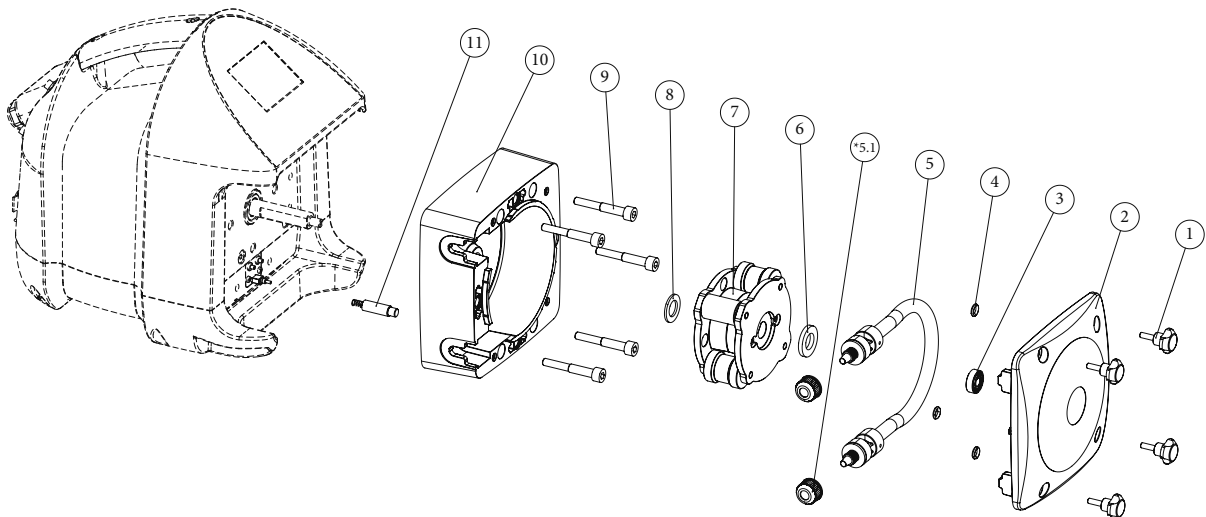

1. Screw
2. Cover
3. Bearing
4. O-ring
5. Tube assembly
6. Washer
7. Rotor assembly
8. Washer
9. Hex socket screw
10. Body
11. Plunger assembly

\* Only with 3/8" tube nut connectors

Remove **Pump Head Cover** by unscrewing four **Thumb Screws**. Pull out **Pump Head Cover**.

The pump detects that the pump head cover has been removed and enters in the Maintenance mode.

**TIP!** Let pump do the work for you. Just guide tubing out between two rollers located on **Rotor** once the second end of the tube is past the second compression roller and is nearing the fitting location, allow the next press roller on the rotation to gently press the tube forward and you can pull the tube in the rest of the way.

Press **STOP** button at any time to stop the pump.

Pull out suction line adapter from Pump Head. Pull out **Tubing Assembly** as the **Rotor** rotates around.

Stop pump by pressing **STOP** button.

Thoroughly clean **Pump Head** and **Rotor**. **Rotor** can be removed by pulling straight out. After cleaning process, push **Rotor** back on shaft. See drawing above for proper assembly.

Locate your new tubing. Please see below on how to install new **Tube Assembly** into **Pump Head**.



Insert suction fitting into pump head. Remove your fingers from pump head. **Start** pump by pressing **START** button. Grab hold of Tube and guide tubing into pump head.



Introduce tubing into pump head while the rotor is rotating, use guide rollers. Avoid using fingers to guide the tubing. Stop pump at anytime by pressing **STOP** button. Start pump by pressing **START** button.

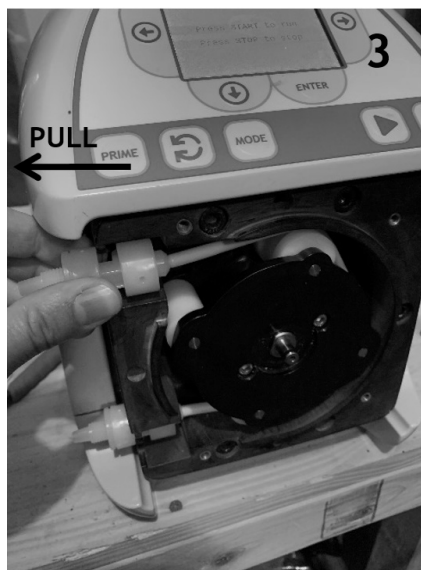

Continue to follow rotation of rotor while directing tube into pump head. At this point, you may need to pull the tube to stretch tubing into position.



Continue to pull the tube to allow enough room to slide discharge fitting into pump head tongue and groove. Once discharge fitting is secured in pump head, stop pump by pressing **STOP** button. Replace pump head cover. Pump will ask you if you'd like to reset tube timer. If you choose **yes**, current tube time will display for 5 seconds before resetting to zero. Make note of your displayed tube life. Select **Yes** again to reset tube life timer.

Re-attach **Pump Head Cover** using the four **Thumb Screws**.

Pump will detect **Pump Head Cover** is installed and begin to exit MAINTENANCE MODE.

Pump will ask you if Tube was replaced. Yes / No

If Yes is selected, pump ask you to reset Tube Timer. Yes / No

If Yes is selected, pump will display Current Tube Timer briefly (5 seconds) before resetting to zero.

The pump can now begin normal operation.

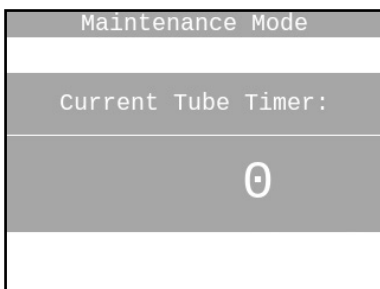
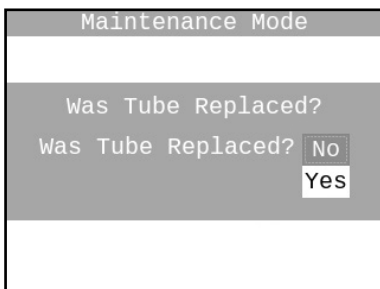
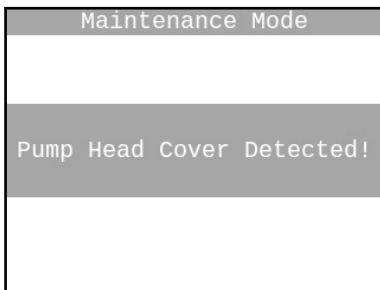

## 6.5 FLOWROX Model FXM2 replacement parts list

FXM2 Replacement Parts List					
		Item	Description	Flowrox Description	Item code
		10	Pump Head	FXM2-TP-PH	112881
		11	Plunger Assembly	FXM2-TP-PA	Q86422
Norprene®	Tubing in this group are interchangeable with single roller assembly (rotor).	7	Roller Assembly (Rotor), For N011, (ND) Tubes : GROUP 1	FXM2-S-G1-R	Q86411
		5.1	Tube Assembly, 3/8" tube connect, Norprene ND (.075 ID)	FXM2-N011-T	103474
		5	Tube Assembly, 1/2" NPT external connect, Norprene ND (.075 ID)	FXM2-N011-TP	103478
Norprene®	Tubing in this group are interchangeable with single roller assembly (rotor).	7	Roller Assembly (Rotor), For N092, N176, (NH, NJ, NK, NKL) Tubes: GROUP 2	FXM2-S-G2-R	Q86515
		5.1	Tube Assembly, 3/8" tube connect, Norprene N092 (.250 ID)	FXM2-N092-T	103480
		5	Tube Assembly, 1/2" NPT external connect, Norprene N092 (.250 ID)	FXM2-N092-TP	103481
		5.1	Tube Assembly, 3/8" tube connect, Norprene N176 (.375 ID)	FXM2-N176-T	103483
		5	Tube Assembly, 1/2" NPT external connect, Norprene N176 (.375 ID)	FXM2-N176-TP	103484
Tygothane®	Tubing in this group are interchangeable with single roller assembly (rotor).	7	Roller Assembly (Rotor), For G176, (GG, GH, GK) Tubes : GROUP 3	FXM2-S-G3-R	Q86516
		5.1	Tube Assembly, 3/8" tube connect, Tygothane G151 (.375 ID)	FXM2-G151-T	103497
		5	Tube Assembly, 1/2" NPT external connect, Tygothane G151 (.375 ID)	FXM2-G151-TP	103498
Norprene® Chemical	Tubing in this group are interchangeable with single roller assembly (rotor).	7	Roller Assembly (Rotor), For T151, (TH, TK) Tubes: GROUP 4	FXM2-S-G4-R	Q86528
		5.1	Tube Assembly, 3/8" tube connect, Norprene Chemical T151 (.375 ID)	FXM2-T151-T	103502
		5	Tube Assembly, 1/2" NPT external connect, Norprene Chemical T151 (.375 ID)	FXM2-T151-TP	103504
		2	Pump Head Cover, Annealed Acrylic	FXM2-AC-PC	Q86412
		1	TRISTAR COVER KNOBS	FXM-SS-TS	102443
		5.1	Tube Nut, Compression, For 3/8" Tubing	FXM2-XX-TN	80580
		Not Shown	Stainless Steel mounting bracket kit (pair)	FXM-SS-MB	102460

PWR CORDS	SUPPLY POWER CABLES USA 125V NEMA 5/15	104139
	SUPPLY POWER CABLES EU 230V CEE7/VII	104141
	SUPPLY POWER CABLES UK 230V BS 1363	104140
	SUPPLY POWER CABLES AUS 230V AS/NZS3112	104204
	SUPPLY POWER CABLES 230V N.A. NEMA6/15	104487



\* ONLY WITH 3/8" TUBE NUT CONNECTORS

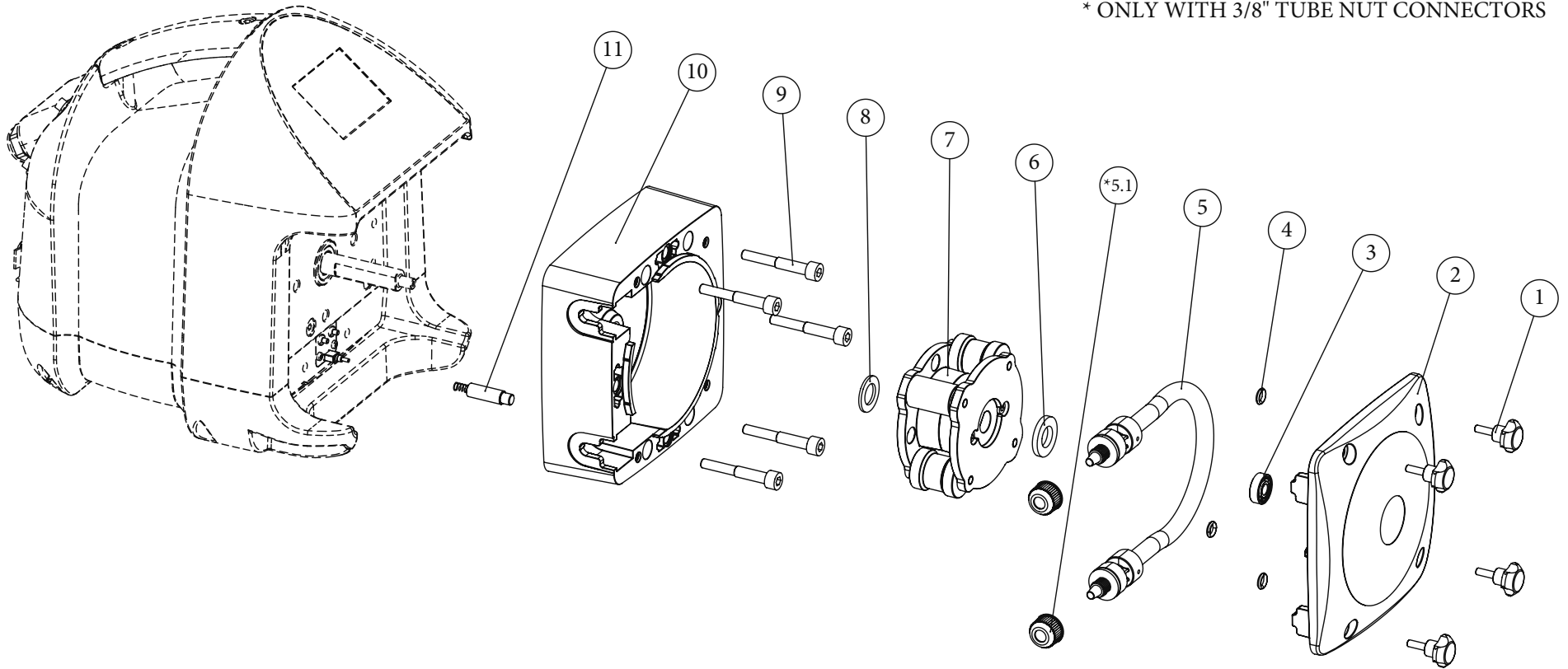

## 6.6 FLOWROX Model FXM3 replacement parts list

FXM3 Replacement Parts List				
	Item	Description	Flowrox Description	Item number
	9	Pump Head	FXM3-TP-PH	112885
	10	Plunger Assembly	FXM3-TP-PA	Q8646
Norprene®	7	Roller Assembly (Rotor), For N151, , (NH, NK,) Tubes : GROUP 1	FXM3-S-G1-R	Q86498
	5	Tube Assembly, 1/2" hose barb connect, Norprene N151 (.250 ID)	FXM3-N151-TB	
	5	Tube Assembly, 1/2" NPT external connect, Norprene N151 (.250 ID)	FXM3-N151-TP	
	5	Tube Assembly, 1/2" hose barb connect, Norprene N269 (.375 ID)	FXM3-N269-TB	103486
	5	Tube Assembly, 1/2" NPT external connect, Norprene N269 (.375 ID)	FXM3-N269-TP	103487
Norprene®	7	Roller Assembly (Rotor), For N151, , (NL, NP) Tubes : GROUP 2	FXM3-S-G2-R	Q86499
	5	Tube Assembly, 1/2" hose barb connect, Norprene N529 (.500 ID)	FXM3-N529-TB	103489
	5	Tube Assembly, 1/2" NPT external connect, Norprene N529 (.500 ID)	FXM3-N529-TP	103490
	5	Tube Assembly, 1/2" hose barb connect, Norprene N840 (.750 ID)	FXM3-N840-TB	103493
	5	Tube Assembly, 1/2" NPT external connect, Norprene N840 (.750 ID)	FXM3-N840-TP	103494
Tygothane®	7	Roller Assembly (Rotor), For G176, (GG, GH, GK) Tubes : GROUP 3	FXM2-S-G3-R	Q86500
	5	Tube Assembly, 1/2" hose barb connect, Tygothane G294 (.375 ID)	FXM3-G294-TB	103500
	5	Tube Assembly, 1/2" NPT external connect, Tygothane G294 (.375 ID)	FXM3-G294-TP	103501
Norprene® Chemical	7	Roller Assembly (Rotor), For T294, (TH, TK, DTH) Tubes: GROUP 4	FXM3-S-G4-R	Q86461
	5	Tube Assembly, 1/2" hose barb connect, Norprene Chemical T294 (.375 ID)	FXM3-T294-TB	
	5	Tube Assembly, 1/2" NPT external connect, Norprene Chemical T294 (.375 ID)	FXM3-T294-TP	
	2	Pump Head Cover, Acrylic	FXM3-AC-PC	Q86480
	1	TRISTAR COVER KNOBS	FXM-SS-TS	102443
	Not Shown	Stainless Steel mounting bracket, 316SS	FXM-SS-MB	102460

PWR CORDS	SUPPLY POWER CABLES USA 125V NEMA 5/15	104139
	SUPPLY POWER CABLES EU 230V CEE7/VII	104141
	SUPPLY POWER CABLES UK 230V BS 1363	104140
	SUPPLY POWER CABLES AUS 230V AS/NZS3112	104204
	SUPPLY POWER CABLES 230V N.A. NEMA6/15	104487

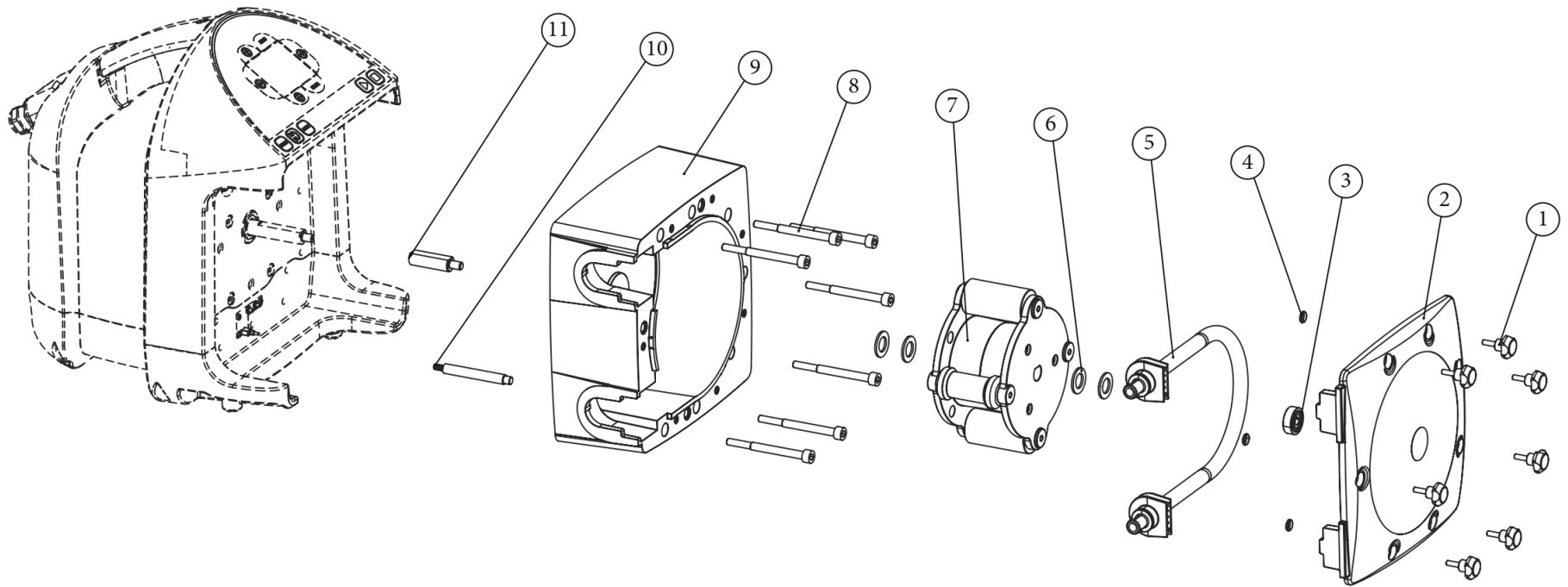

**Valmet Flow Control Oy**

Marssitie 1, 53600 Lappeenranta, Finland.

Tel. +358 10 417 5000

[www.valmet.com/flowcontrol](http://www.valmet.com/flowcontrol)

Subject to change without prior notice.

Neles, Neles Easyflow, Jamesbury, Stonel, Valvcon and Flowrox, and certain other trademarks, are either registered trademarks or trademarks of Valmet Oyj or its subsidiaries in the United States and/or in other countries.

For more information [www.neles.com/trademarks](http://www.neles.com/trademarks)

