

NUFLO™

MC-II™ Flow Analyzer

User Manual

Important Safety Information

Symbols and Terms Used in this Manual



WARNING: This symbol identifies information about practices or circumstances that can lead to personal injury or death, property damage, or economic loss.



CAUTION: Indicates actions or procedures which if not performed correctly may lead to personal injury or incorrect function of the instrument or connected equipment.

Important: Indicates actions or procedures which may affect instrument operation or may lead to an instrument response which is not planned.

Technical Support Contact Information

Cameron
Measurement Systems Division
14450 John F. Kennedy Blvd.
Houston, TX 77032
Phone: 1-800-654-3760; 281-582-9500
Fax: 281-582-9599

NuFlo and MC-II are trademarks of Cameron International Corporation ("Cameron").

© 2006 Cameron International Corporation ("Cameron"). All information contained in this publication is confidential and proprietary property of Cameron. Any reproduction or use of these instructions, drawings, or photographs without the express written permission of an officer of Cameron is forbidden.

All Rights Reserved.
Printed in the United States of America.

Manual No. 100079666, Rev. OE
December 2006

Table of Contents

| | |
|---|-----------|
| Introduction | 1 |
| Specifications – Standard Unit Without Options | 4 |
| Installation | 5 |
| General | 5 |
| Direct Mounting | 5 |
| Remote Mounting..... | 5 |
| Attaching Switchplate Labels | 7 |
| Wiring the MC-II Circuit Board | 8 |
| Operating Your MC-II | 9 |
| RUN Mode Keypad Functions | 9 |
| Save/Store Data..... | 9 |
| Change Decimal Point Position | 9 |
| View Calibration Factor | 10 |
| Adjust LCD Contrast | 11 |
| Zero the Total | 11 |
| Timing Out..... | 11 |
| Correct Overrun Error | 11 |
| Enable Password Security Option | 11 |
| Data Entry Tips | 12 |
| Bypass Security Password | 12 |
| Recalibrating Your MC-II | 13 |
| Example: Liquid Measurement with Preprogrammed Units of Measure..... | 17 |
| Example: Liquid Measurement with User-Defined Units of Measure | 20 |
| Example: Gas Measurement Using a Calculated Divisor | 24 |
| Maintenance | 25 |
| Recalibration | 25 |
| Battery Replacement | 25 |
| Appendix A—Pulse Output Option, Non-Intrinsically Safe | 29 |
| MC-II Pulse Output Circuit Assembly (Part No. 100005121; nonhazardous use) | 29 |
| Pulse Input..... | 29 |
| Pulse Output | 29 |
| Electrical Specifications | 29 |
| Data Entry Tip | 30 |
| Installing the Pulse Output Circuit Assembly | 30 |
| Selecting a Scale Factor | 30 |
| Configuring the Pulse Output Option | 30 |
| Appendix B—Pulse Output Option, Intrinsically Safe | 35 |
| MC-II Pulse Output Circuit Assembly (Part No. 100005163; Intrinsically Safe) | 35 |
| Pulse Input - Intrinsically Safe..... | 35 |
| Pulse Output - Intrinsically Safe..... | 35 |
| Electrical Specifications - Intrinsically Safe..... | 35 |
| Data Entry Tip | 36 |
| Installing the Pulse Output Circuit Assembly | 36 |
| Choosing a Scale Factor..... | 36 |

| | |
|--|-----------|
| Configuring the Pulse Output Option | 36 |
| Appendix C—Lithium Battery Information..... | 39 |
| Lithium Battery Disposal | 39 |
| Transportation Information..... | 39 |

Introduction

The NuFlo MC-II Flow Analyzer combines with a turbine flowmeter to provide an accurate display of accumulated flow volume and flow rate of liquids and gases in a simple-to-use, battery-powered instrument. The MC-II's microprocessor circuitry counts the pulses generated by a companion flowmeter, converts that data into volume and rate values in accordance with calibration settings, and displays the totaled data on two six-digit liquid crystal displays (LCD's). The top LCD indicates total flow volume; the bottom LCD indicates flow rate.

The flow rate decimal point position is determined automatically by the MC-II, as dictated by flow conditions. As the flow rate changes, the flow rate decimal point will shift position to provide maximum resolution.

The MC-II has no internal potentiometers, jumpers, or dip switches to adjust. For applications that rely on standard engineering units, the MC-II automatically calculates the divisor when you supply the calibration factor of the companion flowmeter.

With the simplistic MC-II design, you can save totals in nonvolatile memory with the press of a button on the keypad, or reset the total display (to zero or to a predetermined value).

A password-protection security feature deters unauthorized personnel from altering the calibration or accumulated volume data in the instrument. The security function may be enabled or disabled, using the keypad.

The low current draw of the MC-II's CMOS circuitry enables the MC-II to run for 3 to 5 years on a single 3.6V lithium battery. This durable power supply and the MC-II's noncorrosive weatherproof enclosure make it ideal for use in remote locations.

In addition, the MC-II can be purchased with a pulse-output option that provides a scaled pulse output representing an increment in volume for each pulse. The pulse output function can be disabled when not in use, reducing current consumption. Installation and operation instructions for the pulse output option are provided in Appendices A and B.

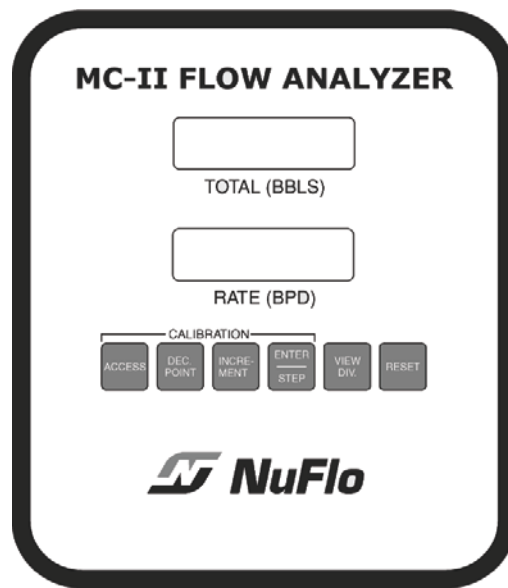

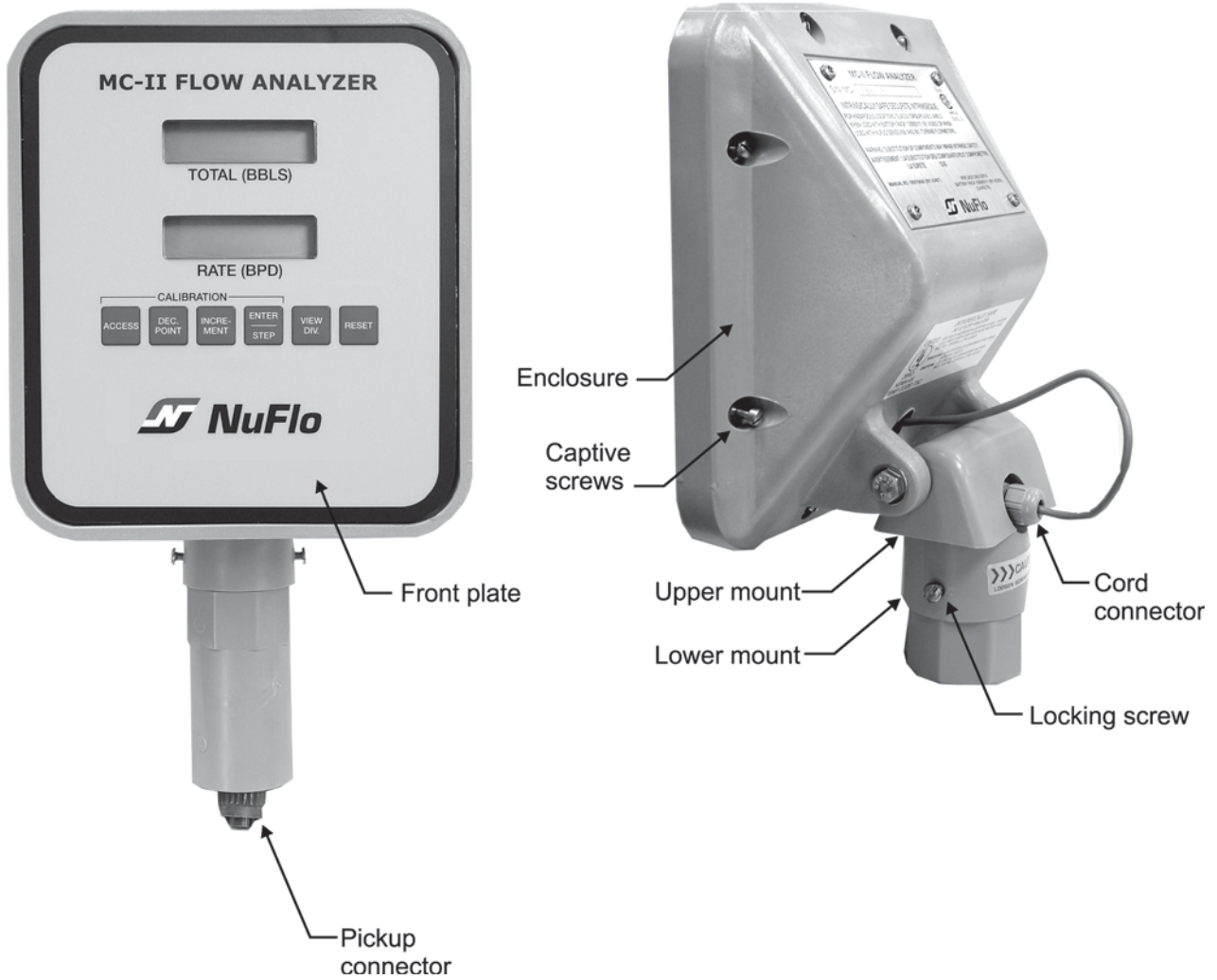

Figure 1—Nomenclature (exterior)

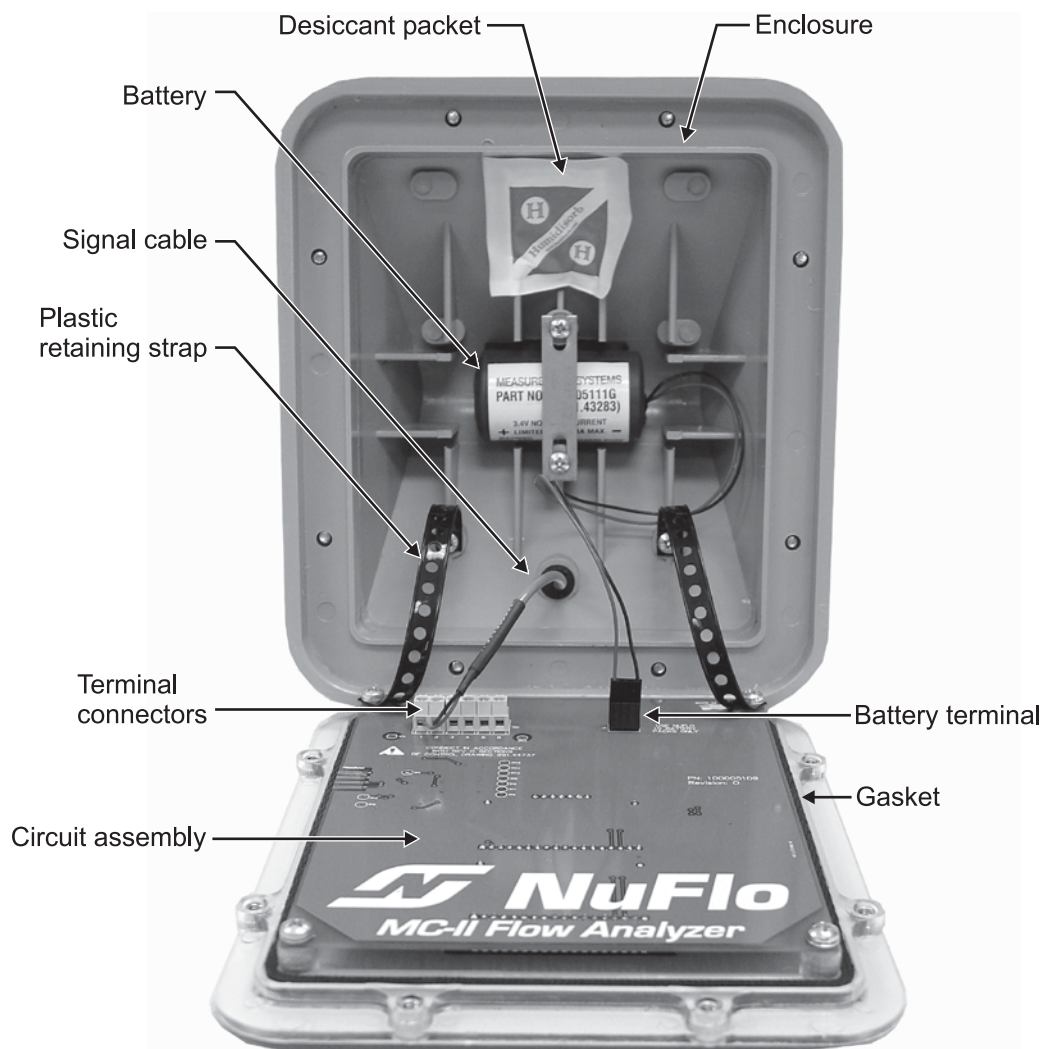

Figure 2—Nomenclature (interior)

Specifications – Standard Unit Without Options

| | |
|---------------------------|---|
| Size: | 7.3 in. wide x 8.3 in. high x 3.4 in. deep |
| Shipping weight: | 6 lb including shipping container |
| Power supply: | One lithium battery (supplied with instrument), Part No. 100005111 Average battery life: 3 to 5 years |
| Temperature range: | -40 to +140°F (-40 to +60°C) |
| Totalizer: | Six digits, 0.5 in. character height, registering barrels (1/10, 1/100 available)* Divisor or calibration factor range: 0.001 to 999,999 |
| Flow rate: | Six digits, registering barrels per day* Updates once per second |
| Accuracy: | ±1 count (totalizer) |
| Input frequency: | 0 to 3500 Hz |
| Input amplitude: | 30 to 3000 mV peak to peak |
| Signal cable: | 1-ft length |
| Mounting: | MC-II enclosure mounts directly on a weatherproof pickup adapter (provided) which threads onto the turbine meter. The pickup adapter tilts and swivels for ease in optimizing visibility of the displays. |
| Compliances: | CSA certified intrinsically safe in hazardous locations Class I, Division 1, Groups A,B,C,D Type 4 enclosure |

* Default settings are barrels (volume) and barrels per day (rate) unless otherwise specified at the time of order.

Installation

General

The MC-II Flow Analyzer is most commonly mounted directly on top of its companion flowmeter. However, if the flowmeter is in a line that has vibration or if the meter's location makes a direct mount difficult, the MC-II can be mounted on vertical or horizontal 2-in. pipe (additional hardware is required).

With either installation method, the mounting location should be free of vibration, and the MC-II should be oriented so that the liquid crystal displays (LCDs) are not exposed to direct sunlight.

Direct Mounting

In preparation for the installation of the MC-II, install the companion flowmeter in the flow line and install the magnetic pickup according to the flowmeter instruction manual. Grease the pickup threads that mate with the flowmeter body and the pickup threads that mate with the MC-II signal cable connector to facilitate easy removal in the future.

If the remote mounting option was ordered with the MC-II, see "Remote Mounting" for installation instructions.

The MC-II is fully assembled at the time of shipment. To install the MC-II, perform the following steps:

1. Plug the MC-II cable connector into the pickup and turn the swivel nut clockwise until the connector is fully inserted into the pickup and the swivel nut is hand-tight.
2. Loosen the locking screws that secure the base MC-II mount (Figure 1, page 2).
3. Position the MC-II on the flowmeter, carefully pulling excess signal cable through the strain relief cord connector on the side of the upper mount (see Figure 2, page 3).
4. Thread the base of the mount onto the conduit adapter of the turbine meter and tighten two extra rounds after it is hand-tight. It is important that the upper mount and MC-II readout be kept from turning while the base is being tightened in order to prevent the signal cable from being damaged by twisting.
5. Tighten the outside nut of the strain relief cord connector on the upper mount with a 15-mm open-end wrench to prevent cord slippage.
6. Adjust the MC-II readout for best viewing position and tighten the locking screws in the upper mount. The viewing angle may be adjusted by loosening the nut on the bolt which holds the MC-II readout on the upper mount, tilting the unit to the desired angle and retightening the nut.

Remote Mounting

In most applications, the MC-II Flow Analyzer is installed directly on top of the flowmeter. However, if the flowmeter is in a line that has vibration or if the meter's location makes a direct mount difficult, a remote mount may be preferred. Remote mounting hardware allows the MC-II to be mounted on a 2-in. pipe.

The remote mounting option kit consists of a mounting bracket, "U" bolts, nuts and lock washers, weather-proof adapter, and 10-ft signal cable assembly. Additional signal cable length is available if required.

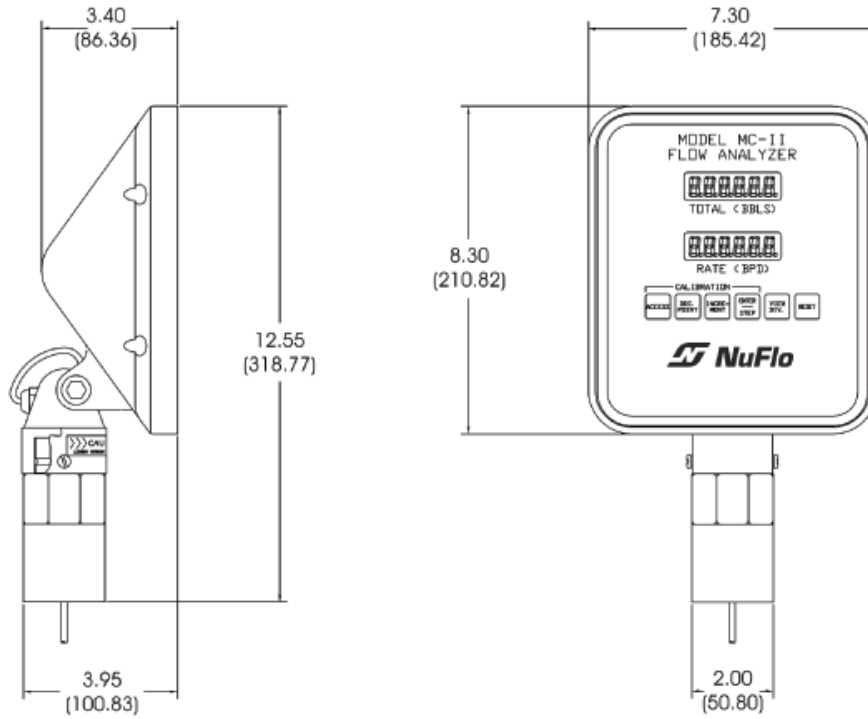

Figure 3—Direct mount dimensions (inches and millimeters)

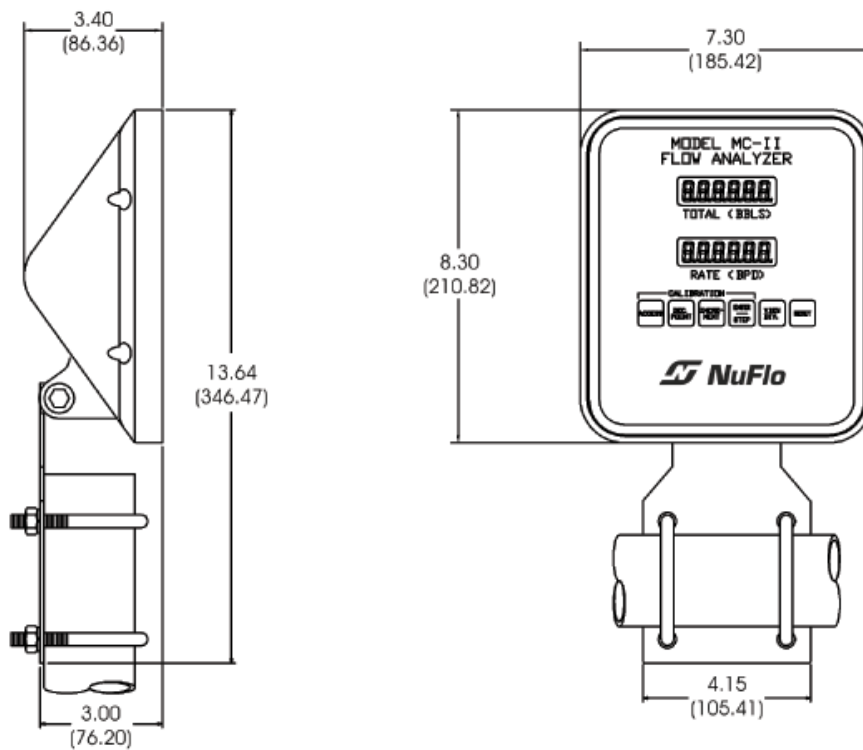

Figure 4—Remote mount dimensions (inches and millimeters)

To install the MC-II with the remote mount option, perform the following steps:

1. Place the “U” bolts around the pipe the MC-II is to be mounted on, then through the mounting bracket. Note that the holes in the mounting bracket are arranged such that it may be used with horizontal or vertical pipe. (Note: Disregard the center hole in the mounting bracket.)
2. Fasten the bracket with the lock washers and nuts.
3. Use the bolts, lock washers and nuts provided to attach the MC-II to the bracket. Position the MC-II to the viewing angle desired before tightening the nut.



CAUTION: Before performing the next step, make sure the enclosure is in a well-ventilated area and avoid breathing fumes that could be trapped inside. Under normal operating conditions, the lithium battery that powers the MC-II is a sealed unit and poses no hazard when the enclosure is opened. However, a leak in a lithium battery could expel toxic fumes into the enclosure. If the battery appears to be damaged, adhere to the safety precautions and follow the disposal instructions provided in Appendix C.

4. Open the enclosure and install the signal cable as follows:
 - a. Feed cable through the rubber grommet and make a knot or install a cable tie inside housing, allowing enough free length to connect wires to the terminal connector.
 - b. Feed the black lead and shield into terminal connector number 2 and screw retainer down tight.
 - c. Feed red or white lead into terminal connector number 1 and screw retainer down tight.
 - d. Close the enclosure and retighten all eight screws.

Attaching Switchplate Labels

Each MC-II is shipped with a label set containing commonly used volume and flow rate units of measure labels. Unless otherwise specified, the MC-II default units are barrels (volume), and barrels per day (rate). If a different unit of measure will be used, place the appropriate label on the front panel below the respective LCD viewing window. Make sure that the labels match the configuration (see “Recalibrating Your MC-II”).

Wiring the MC-II Circuit Board

The MC-II's simplistic design makes wiring easy. See the wiring diagram below for reference in properly wiring the MC-II to the battery and the flowmeter.

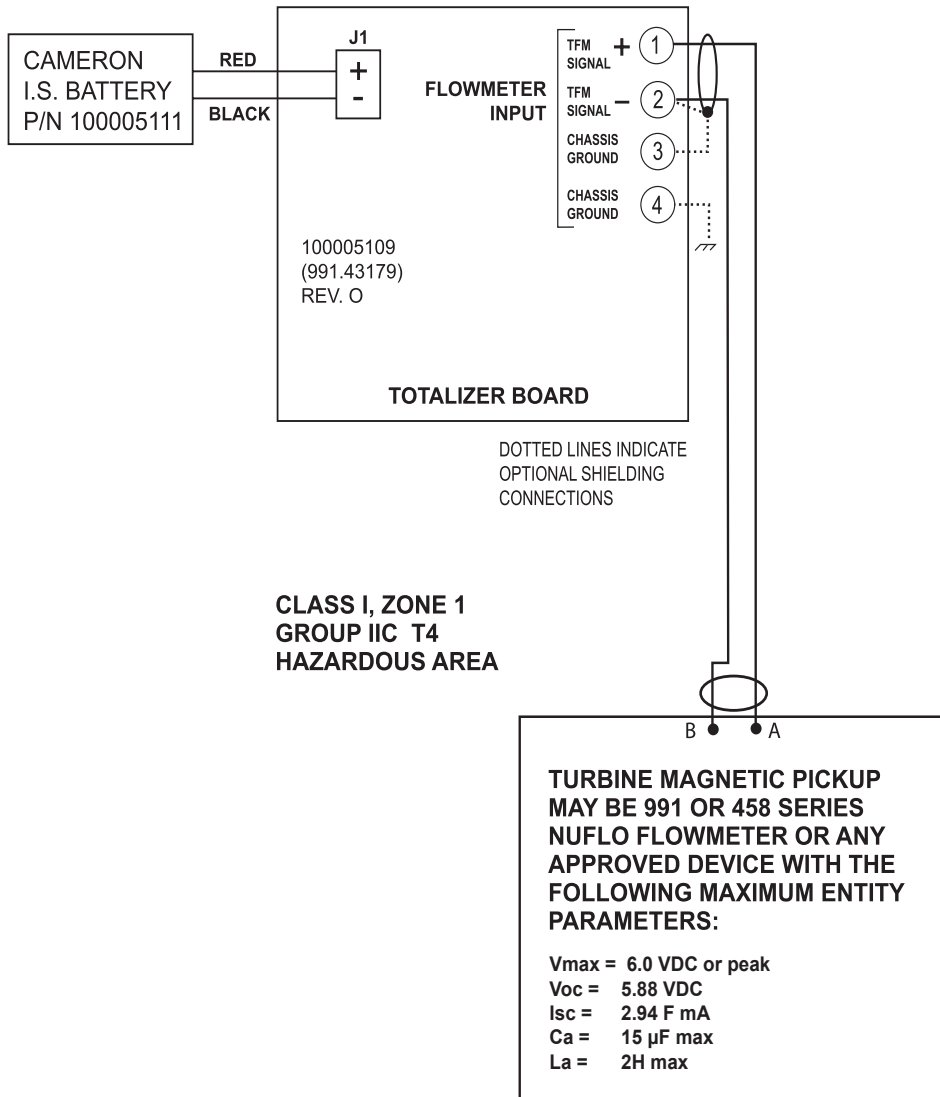

Figure 5—Wiring of the MC-II circuit board (MC-II Flow Analyzer is CSA-approved for use in HAZARDOUS areas when installed in accordance with drawing 101231210 shown above)

Operating Your MC-II

If you purchased a companion NuFlo flowmeter with your MC-II Flow Analyzer, the MC-II has been calibrated for use with that flowmeter at the factory, and your MC-II is ready for operation as soon as the installation is completed.

If you did not purchase a NuFlo flowmeter with the MC-II, or if the MC-II is being used with a different flowmeter, you must recalibrate the MC-II before placing it into service. See “Recalibrating Your MC-II,” page 13, for instructions.

When fluid begins to pass through the flowmeter, the MC-II will register total accumulated flow volume in the top LCD and instantaneous flow rate in the bottom LCD. Decimal points will appear in their proper position in the displays when the unit is properly calibrated.

The MC-II has two modes of operation, Run Mode and Calibrate Mode. The Run Mode is the standard operating mode during which the instrument displays flow rate and volume. The Calibrate Mode of the MC-II allows entry of calibration data into the instrument using the six red keys aligned on the switchplate. Abbreviated menu names will appear in the upper display, and calibration data will be entered in the lower display. As indicated on the switchplate, the first four keys are primarily used for calibrating the MC-II. The **VIEW DIV** and **RESET** keys are used primarily in the Run mode. See Table 1 (page 10) for a description of all keypad functions.

Due to the limitations of a 7-segment character, some of the letters in the menu names will be uppercase and some will be lowercase. All available unit abbreviations for volume totals and flow rate are listed in the outside column of this page.

RUN Mode Keypad Functions

Save/Store Data





Loss of battery power can result in the loss of unsaved data. To store the total accumulated flow volume to nonvolatile memory, press **ENTER/STEP** each time you check the flow. The saved total accumulated volume value will be available when battery power is restored.

Total accumulated volumes are also automatically saved each time you exit the Calibrate menu.









Change Decimal Point Position

Volume readouts can be displayed in values as small as 0.001 of a unit by changing the decimal point position. In Run mode, press **DEC. POINT** until the desired decimal position is achieved. The decimal point position in flow rate readouts adjusts automatically and cannot be changed.

Volume Units

| | |
|---|----------------|
|  | = barrels* |
|  | = gallons |
|  | = cubic meters |
|  | = liters |
|  | = user-defined |

Flow Rate Units

| | |
|---|----------------|
|  | = bbls/day* |
|  | = gal/min |
|  | = cubic m/day |
|  | = liters/min |
|  | = per day** |
|  | = per hour** |
|  | = per minute** |
|  | = per second** |

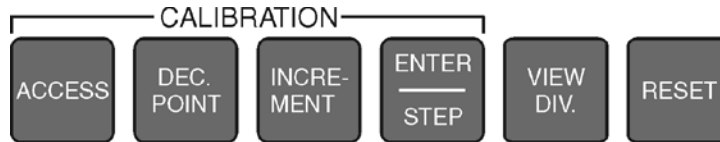

Table 1—MC-II Keypad Functions

| RUN MODE FUNCTIONS | |
|--------------------------|--|
| ENTER/STEP | Saves current volume total in nonvolatile memory. |
| RESET | Allows user to zero the volume. |
| VIEW DIV | Displays the current calibration factor. |
| DEC. POINT | Changes the position of the decimal point in the TOTAL (top) display. |
| INCREMENT | Adjusts the LCD contrast. |
| CALIBRATE MODE FUNCTIONS | |
| ACCESS | Places the MC-II in the Calibrate Mode and permits you to perform the following tasks: Set units of measure for the TOTAL (top) display. Set the calibration factor. Set the units of measure for the RATE (bottom) display. Select or deselect the pulse output option. Select or deselect the password-protected security option. Preset a total. (If an MC-II must be replaced, the user can enter the volume from the previous analyzer and prevent the loss of this data when the volume count resumes. See Step 7 of the calibration procedure on page 16.) SHORTCUT: Press and hold ACCESS for 3 seconds, then release to accept an existing NUMERICAL calibration setting and advance to the next menu option. This shortcut is applicable to NUMERICAL data fields only. |
| DEC. POINT | Moves the position of the decimal point when entering numerical data such as a calibration factor. |
| INCREMENT | Scrolls/toggles through available settings for each menu option, and allows the user to change the flashing digit when inputting numerical settings. A single press advances digits/text entries to the next available setting. Depressing and holding the INCREMENT key scrolls through all digits. |
| ENTER/STEP | Accepts the calibration setting shown on the display and advances to the next data entry position (flashing digit field) or menu option. |
| RESET | Allows the user to re-enter a numerical value in the bottom display (if the value has not been accepted by pushing the ENTER/STEP button. To re-enter the value, press and hold RESET for 3 seconds, then release. The right-most digit will begin flashing, allowing the user to re-enter the value, right to left. |



View Calibration Factor

Press **VIEW DIV** key at any time during the Run mode to view the current calibration factor. If the MC-II is programmed to display a preprogrammed unit, the calibration factor will be displayed in pulses per gallon, and the abbreviation PuP.gAL will appear in the top LCD window.



If the MC-II is programmed to display a user-defined unit, “uSEr” will appear in the top LCD window, and a calculated divisor will be displayed in the bottom window. See “Example: Liquid Measurement with User-Defined Units of Measure” on page 20 for more information.



Adjust LCD Contrast

Dramatic changes in temperature may cause changes in the LCD contrast. To adjust this contrast in Run mode, press **INCREMENT** repeatedly or press it and hold to scroll through the various contrast levels.

Zero the Total

At times, a user may wish to reset the volume total to zero. To reset the volume total, perform the following steps:

1. Verify that the instrument is in Run mode.
2. Press and hold **RESET** for 3 seconds and release.
 - a. If the security option is disabled, the total display will automatically revert to all zeros.
 - b. If the security option is enabled, you will be prompted for a password. See “Enable Password Security Option” below. If the correct password is entered, the total will reset to zero.

Timing Out

If the MC-II is left in the Calibrate mode for longer than 1 minute, it will time-out and return to the Run mode. Data stored with the **ENTER/STEP** key will be saved. Data that was selected but not entered will be lost.

Correct Overrun Error

If the calculated flow rate contains more than six digits, the MC-II will generate an overrun error. A prompt, **oU run**, will appear in the lower LCD. To correct this error, enter the Calibrate Mode and change the flow rate unit.

Enable Password Security Option

Your MC-II is designed with a password-protected security option to help deter unauthorized personnel from adjusting calibration settings. When the security function is enabled, the user will be prompted for a password each time he presses **ACCESS** to enter Calibrate mode (immediately following the diagnostic test).

The security option is disabled before the MC-II is shipped from the factory. To enable the security function, perform the following steps:

1. Press and hold **ACCESS** for 3 seconds, then release, to enter Calibrate mode. Following a quick diagnostic test, the **Code** prompt will appear in the top display. The bottom display should read **no**.
2. Press **INCREMENT** to toggle the bottom display setting to **YES**.
3. Enter a password containing up to six digits, entering the digits from left to right. If the password contains less than six digits, enter zeros for the remaining digits.
4. Press **ENTER/STEP** to accept this selection.

To disable the security function, repeat Step 1, and press **INCREMENT** to toggle the bottom display setting to **no**. Press **ENTER/STEP** to save the selection.

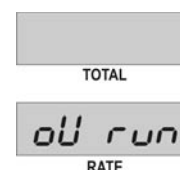

Select or deselect the Password Security option.

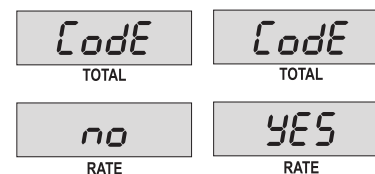

Press **ACCESS + RESET** simultaneously to display the **bYPASS** menu.

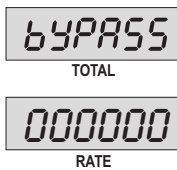

Call 1-800-654-3760 to request a one-time security bypass code.

Bypass Security Password

Forget your password? With the MC-II, you can have your access restored quickly and easily with a one-time bypass code.

To obtain this bypass code, perform the following steps:

1. Press and hold **ACCESS** and **RESET** simultaneously for 3 seconds, then release. The word “bYPASS” will appear in the upper display, and a number will appear in the lower display.
2. Record this number (it will remain on the display panel only for a few seconds).
3. Call a Cameron (Measurement Systems Division) representative, and give him/her the number and the serial number of the MC-II. After verifying your identity, he/she will provide you with a one-time bypass code.
4. Enter the bypass code in place of your password at the **CodE** prompt.

Important—Prior to exiting the Calibration menu, the **CodE** menu is displayed again, and zeroes will appear in the bottom display. Select a password using the **INCREMENT** key, and press **ENTER/STEP** to save your password.

Data Entry Tips

To re-enter a numerical calibration setting before you have selected and saved the last digit, press and hold **RESET** for 3 seconds, then release. The right-most digit will resume blinking, allowing you to enter the entire number again.

To retain a numerical calibration setting and advance to the next menu without pressing **ENTER/STEP** repeatedly, press and hold **ACCESS** for 3 seconds, then release. This shortcut applies only to numerical fields. You must press **ENTER/STEP** to select all other entries.

If the MC-II is left in the Calibrate mode for longer than 1 minute, it will time-out and return to the Run mode. Data that has been saved with the **ENTER/STEP** key will be saved. However, data that was selected but not entered will be lost.

Recalibrating Your MC-II

If your MC-II was purchased as a system, it was calibrated at the factory with its companion NuFlo turbine flowmeter. Verify the calibration settings to ensure that no further calibration is required prior to use.

If you purchased a stand-alone MC-II without a flowmeter, the MC-II must be calibrated before being operated.

The following information is needed to calibrate the MC-II:

- unit of measure for volume
- flowmeter calibration factor (in pulses per gallon)
- unit of measure for flow rate

The calibration procedure is explained in detail below.

1. Press and hold **ACCESS** for 3 seconds, then release, to enter Calibrate mode. Following a quick diagnostic test, **Prog.no** will appear in the top display and the version number of the firmware will appear in the bottom display for 1 to 2 seconds.

The **tot.Eng** menu will then appear in the top display. The factory default volume unit - bbl - will appear in the bottom display.

IMPORTANT: If the pulse output option is in use, you must select uSEr as the unit of measure for volume. Any other selection will cause the pulse output to yield an incorrect number of pulses.

2. To select a unit of measure for volume: bbl, gal, m³, liter, or user-defined, press **INCREMENT** repeatedly until the appropriate unit of measure appears in the bottom display. Press **ENTER/STEP** to accept the selection.
 - If you select a preprogrammed unit, the **Pu.P.gAL** menu will appear in the top display, allowing you to enter the calibration factor of your companion flowmeter. The MC-II will automatically calculate the divisor. Proceed to Step 3 for further instruction.
 - If **uSEr** is selected, **Ent.diV** will appear in the top display, prompting you to enter a calculated divisor in terms of the unit specifications. Enter the divisor, from right to left, using the **INCREMENT** key to select each digit, and the **ENTER/STEP** key to accept each digit selection. Then proceed to Step 4 for further instruction. An example of MC-II calibration with user-defined units is provided on page 20.

Press **ACCESS** to enter Calibration mode.

Prog.no
TOTAL

1.30
RATE

Set unit of measure for VOLUME.

Factory default setting is bbl.

tot.Eng
TOTAL

bbl
RATE barrels

gallons 9AL
RATE

cubic meters nn3
RATE

liters L i t E r
RATE

user-defined uSEr
RATE

Ent.d iV
TOTAL

000000
RATE

Enter the calculated divisor for the user-defined volume unit.

(Applicable only when user-defined unit is selected for volume.)

Enter the Calibration factor from your turbine flowmeter.

(Applicable only when preprogrammed unit is selected for volume.)



Set unit of measure for RATE.

Factory default setting is bpd.

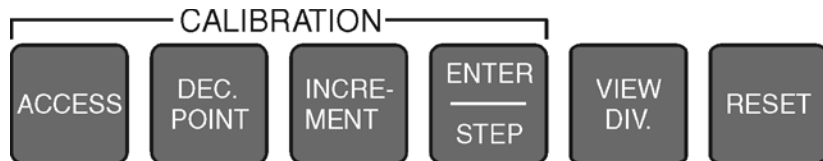
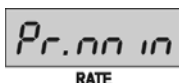

3. Locate the calibration factor (pulses per gallon) of the turbine flowmeter. This factor is typically recorded on a plastic tag attached to the meter. Enter the number into the MC-II as follows:
 - a. Press **DEC. POINT** repeatedly to position your decimal point in the proper position for your calibration factor.
 - b. Enter digits from right to left. The right-most digit will flash, indicating the digit being changed.
 - c. Press **INCREMENT** repeatedly to advance the digits from 0 to 9, or press and hold **INCREMENT** to scroll through the digits to make the appropriate selection. Then, press **ENTER/STEP** to save it and advance to the next digit. Repeat this step to enter all six digits.
 - d. If your calibration factor is less than six digits in length, enter 0 for each of the unused digits at the left.

When you have entered the last of the six digits and pressed **ENTER/STEP**, the calibration factor will be saved in the MC-II's memory and the **rAt.Eng** menu will appear in the top display.

4. At the **rAt.Eng** prompt, select a unit of measure for rate:

- barrels per day (b.P.d)
- gallons per minute (g.P.nn)
- cubic meters per day (nn3.P.d)
- liters per minute (Lit.P.nn)
- <preselected volume unit> per day (PEr.dAY)
- <preselected volume unit> per hour (PEr.Hr)
- <preselected volume unit> per minute (Prnn in)
- <preselected volume unit> per second (PEr.SEC)

To select a unit of measure, press **INCREMENT** repeatedly until the appropriate unit of measure appears in the bottom display. Press **ENTER/STEP**.

If you selected a user-defined unit of measure for volume in Step 2, your rate unit options will be per day, per hour, per minute, or per second.

The **PULSE** menu will appear in the top display.

5. Select or deselect the Pulse Output option. The default setting is **OFF**.

If your MC-II is **not** configured with the pulse output option, press **ENTER/STEP** to accept the default setting, **OFF**, and proceed to Step 6.

If your MC-II is configured with the pulse output option, you have the option of leaving the option disabled (**OFF**), or entering a scale factor.

To enter a scale factor, press **INCREMENT** repeatedly to select the volume increment that will cause a pulse output to occur. Press **ENTER/STEP** to accept the selection. For instruction on choosing an appropriate scale factor, see Appendices A and B.

The **Code** menu will appear in the top display.

6. Enable/disable the password-protected security feature by accepting the default **no** setting on the **Code** menu, or by pressing **INCREMENT** to toggle the setting to **YES**. Press **ENTER/STEP** to save the setting. The bottom screen will change to a numerical data entry field, prompting you to enter a numeric password of up to six digits.

Note—Choose a number that is easily remembered. Record the password for future reference if necessary. You will be asked for it each time you press **ACCESS** (to enter the Calibration mode) or **RESET** (to reset the total). For more information on the password protection security feature, see “Enable Password Security Option,” page 11.

Select or deselect the Pulse Output option.

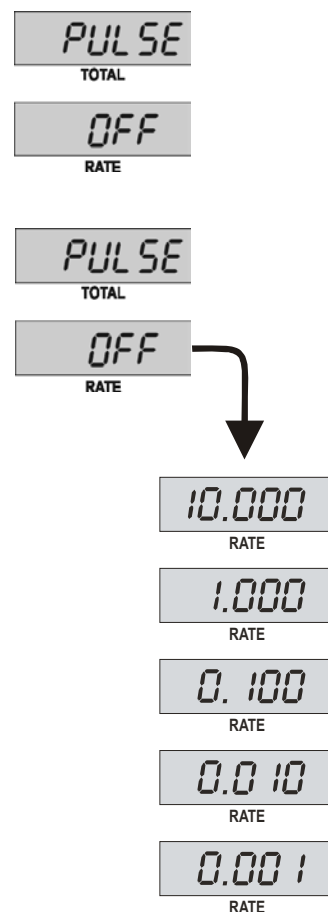

Select or deselect the Password Security option.

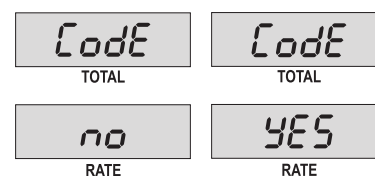

Enable or disable the Preset Total option.

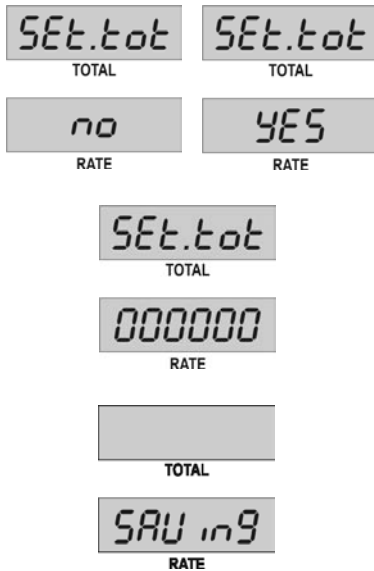

7. The prompt **SEt.tot** will appear in the top display, and **no** (default setting) will appear in the lower display.

- a. If you do not need to preset a total, press **ENTER/STEP** to bypass this menu selection.

The prompt **SAVing** will appear in the lower display while the calibration settings are saved to nonvolatile memory. The MC-II will automatically return to the Run mode.

- b. To preset a total, press **INCREMENT** to toggle the bottom display from **no** to **YES**. Press **ENTER/STEP** to accept the selection. A series of zeros will appear in the bottom display, and the right-most digit will begin flashing, allowing you to enter a total. Enter the digits for the preset value, right to left, by pressing **INCREMENT** repeatedly to select the appropriate digit, then pressing **ENTER/STEP** to accept the selection. Repeat this process for all digits. When the last digit has been entered and **ENTER/STEP** is pressed, the calibration is complete.

The prompt **SAVing** will appear in the lower display while the calibration settings are saved to nonvolatile memory. The MC-II will automatically return to the Run mode and begin totalizing volume beginning with the new preset total.

Important—If the unit of measure selected for the flow rate results in a rate that contains too many digits to be displayed in the LCD window, the MC-II will generate an overrun error. A prompt, **oU run**, will appear in the bottom display. To correct this error, press and hold **ACCESS** for 3 seconds, then release, to reenter the Calibrate mode; then select a larger unit of measure for the flow rate.

Example calibration procedures are provided on the following pages for these basic applications:

- liquid measurement with preprogrammed units of measure (page 17)
- liquid measurement with user-defined units of measure (page 20)
- gas measurement (page 24)

Example: Liquid Measurement with Preprogrammed Units of Measure

Calibration Information

- The MC-II will be mounted on a 1-in. NuFlo liquid turbine meter.
 - The meter factor is 907.68 pulses per gallon.
 - The volume will be measured in barrels and displayed in tenths of a barrel.
 - The pulse output will not be utilized.
 - The security code is disabled.
 - The MC-II is in the Run mode.
 - No preprogrammed volume is to be entered.
1. Press and hold **ACCESS** for 3 seconds, then release, to enter the Calibrate mode. The MC-II performs a diagnostic test that momentarily displays all segments of the LCD, and then displays the firmware version by showing **Prog.no** on the upper display and the firmware version on the lower display.
 2. After the diagnostics routine is complete, the upper display will show the prompt **tot.Eng**. Pressing **INCREMENT** will allow you to scroll through the available volume units of measurement (BBL, GAL, M³, LitEr, or uSEr; factory default is BBL). Press **INCREMENT** until BBL is selected. Press **ENTER/STEP**.
 3. The upper display will show **Pu.P.gAL**, prompting you to enter the meter factor in pulses per gallon. The lower display will show the previously entered meter factor. The factory default is 900.00. The right-most digit, the hundredths position, will blink, indicating it is the digit currently selected for editing.
 - a. Since 8 is to be entered in the hundredths position (for the factor 907.68), press **INCREMENT** until 8 is displayed. (If the desired digit is accidentally passed, continue to press **INCREMENT** until that digit is displayed again.)

Press **ENTER/STEP** to accept the selection of the digit 8. The digit to the left of the 8 (the tenths position) will begin blinking.
 - b. Since 6 is to be entered in the tenths position (for the factor 907.68), press **INCREMENT** until 6 is displayed.

Press **ENTER/STEP** to accept the selection of digit 6. The digit to the left of the 6 (the ones position) will begin blinking.
 - c. Press **INCREMENT** until 7 is displayed. Press **ENTER/STEP** to accept the selection and proceed to the tens position.
 - d. Press **INCREMENT** until 0 is displayed. Press **ENTER/STEP** to proceed to the hundreds position.

Press **ACCESS** to enter Calibration mode.

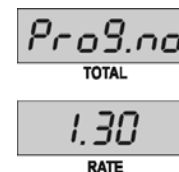

Set unit of measure for **VOLUME**.

Factory default setting is bbl.

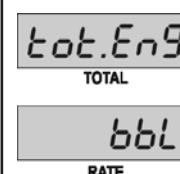

Enter the Calibration factor from your turbine flowmeter.

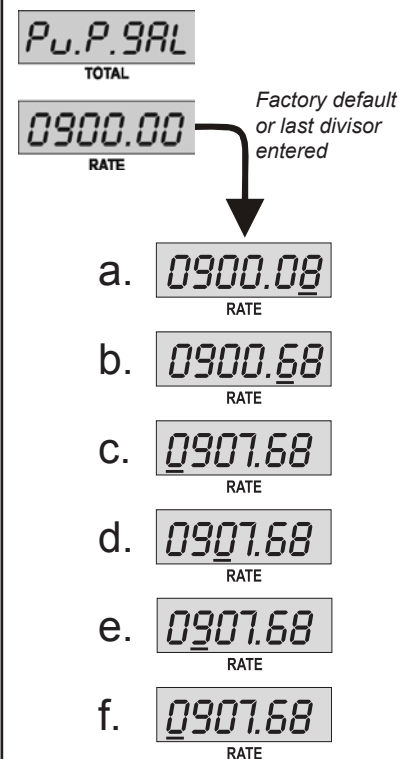

Underline denotes the flashing digit to be changed.

Set unit of measure for RATE.

Factory default setting is bpd.

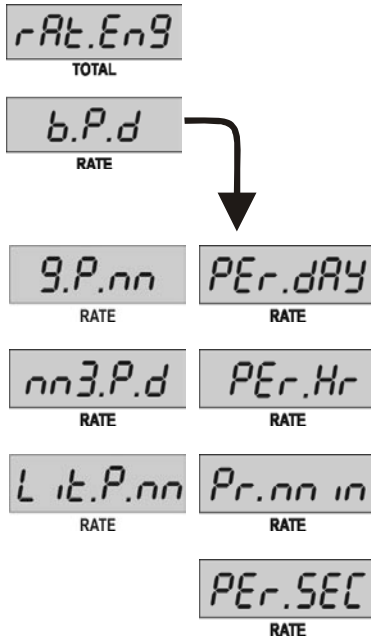

Deselect the Pulse Output option.

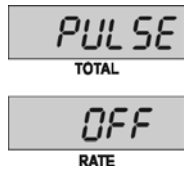

- e. Press **INCREMENT** until 9 is displayed. Press **ENTER/STEP** to accept the selection and proceed to the thousands position. Since the meter factor is now entered, the remaining digit to the left of the factor must be zero.
- f. Press **INCREMENT** until 0 is displayed.
Press **ENTER/STEP** to accept the selection. You have now completed the entry of the calibration factor.

4. The upper display will show **rAt.Eng**, prompting you to enter the units of measure for the flow rate. Pressing **INCREMENT** will allow you to scroll through the engineering flow rate units of measure:

- barrels per day (bpd) - factory default
- gallons per minute (g.P.nn)
- cubic meters per day (nn3.P.d)
- liters per minute (Lit.P.nn)
- <volume unit> per day (PER.dAY)
- <volume unit> per hour (PER.Hr)
- <volume unit> per minute (Pr.nn in)
- <volume unit> per second (PER.SEC)

Press **INCREMENT** until **b.P.d** is shown on the bottom display. Press **ENTER/STEP**.

5. The upper display will show the prompt **PULSE** and the lower display will show the factory default setting, **OFF**.

Since pulse output is not in use in this example, press **ENTER/STEP** to accept the **OFF** selection.

If the lower display shows a setting other than **OFF**, press **INCREMENT** until **OFF** is shown. (See Appendices A and B for information on configuring the pulse output feature.)

6. The upper display will show the prompt **Code** and the lower display will show **no**. Press **ENTER/STEP** to accept the factory default **no** setting, disabling the security code feature.

If **YES** appears in the lower display, press **INCREMENT** until **no** is shown. (See “Enable Password Security Option,” page 11, for more information on security settings.) Press **ENTER/STEP** to accept the selection.

7. The prompt **SEt.tot** will appear in the top display, and **no** (default setting) will appear in the lower display.

Since no preprogrammed total is to be entered for this example, press **ENTER/STEP** to bypass this menu selection.

The prompt **SAVing** will appear in the lower display while the calibration settings are saved to nonvolatile memory. The MC-II will automatically return to the Run mode.

In Run mode, press **DEC. POINT** to position the decimal point in the top (volume) display to show tenths.

Deselect the Password Security option.

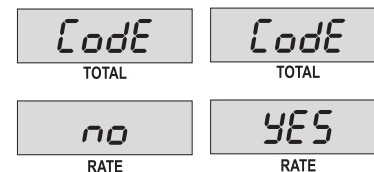

Bypass the Preset Total option.

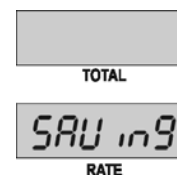

Press **ACCESS** to enter Calibration mode.



Set unit of measure for **VOLUME**.

Factory default setting is bbl.

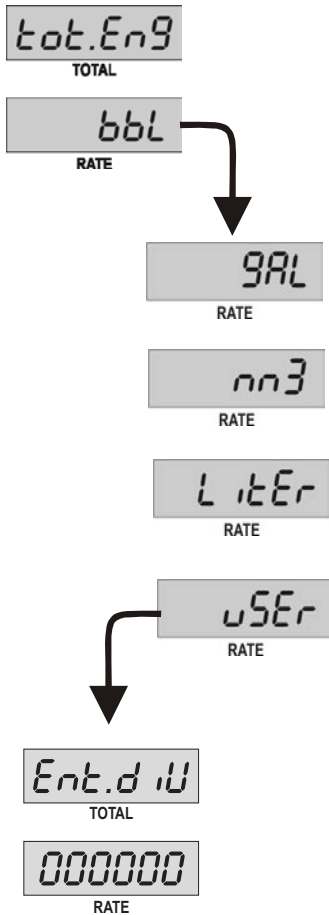

Example: Liquid Measurement with User-Defined Units of Measure

Calculating the divisor for liquids is necessary when registering the volume in units other than barrels, gallons, cubic meters, or liters. User-defined (**USER**) units may be used for the volume total and preprogrammed units for the flow rate.

Note—Each MC-II is shipped with a label set (Part No. 100080190) containing labels for commonly used flow rate and volume units. The appropriate label can be placed on the front panel on the right side of the LCD viewing window.

Calibration Information

- A NuFlo 3/4-in. turbine meter is being used to measure injected water for a water flood project.
- The turbine meter calibration factor is 2977.01 pulses per gallon.
- The volume is to be measured in kiloliters and displayed to an accuracy of one-tenth of a kiloliter.
- The units of measure for flow rate will be kiloliters per day.
- No preprogrammed volume is to be entered.
- The pulse output will not be used.
- The security code is disabled and the MC-II is in the Run mode.
- The MC-II has not been calibrated and is at factory default settings.

Step-by-Step Calibration Procedure

1. Calculate the divisor and divisor decimal point position.
 - a. Determine the factor for converting gallons to kiloliters. Since there are 264.17 gallons per kiloliter, the conversion factor for this example is 264.17.
 - b. Use the following formula to determine the divisor.

$$\text{Divisor} = \text{Meter factor in pulses per gallon} \times \text{conversion factor for pulses per unit volume of desired measure}$$

$$\text{Divisor} = 2977.01 \times 264.17 = 786,436.73.$$
 - c. Round the divisor to six digits (to accommodate the six-digit limit of the MC-II display). In this example, the divisor to be entered into the MC-II is 786,437.
2. To begin the calibration process, press and hold **ACCESS** for 3 seconds, then release, to enter the Calibrate Mode. The MC-II performs a diagnostic test that momentarily displays all segments of the LCD. The firmware version is then displayed by showing **Prog.no** on the upper display and the firmware version on the lower display.

3. After the diagnostics routine is complete, the upper display will show the prompt **tot.Eng**. Press **INCREMENT** until **USER** appears on the lower display. Press **ENTER/STEP** to confirm the selection.
4. The upper display will show **Ent.diV**, prompting you for the divisor. The lower display will show the previously entered meter factor (factory default is 230.00). The right-most digit (the ones position) will blink, indicating it is the digit currently selected for editing.
 - a. Remove the decimal point by pressing **DEC. POINT** repeatedly.
 - b. Press **INCREMENT** until 7 is displayed in the ones place. (If you accidentally pass the desired digit, continue to press **INCREMENT** until that digit is displayed again.) Press **ENTER/STEP** to proceed to the next digit (tens position).
 - c. Press **INCREMENT** until 3 is displayed. Press **ENTER/STEP** to proceed to the next digit (hundreds position).
 - d. Press **INCREMENT** until 4 is displayed. Press **ENTER/STEP** to proceed to the next digit (thousands position).
 - e. Press **INCREMENT** until 6 is displayed. Press **ENTER/STEP** to proceed to the next digit (ten thousands position).
 - f. Press **INCREMENT** until 8 is displayed. Press **ENTER/STEP** to proceed to the next digit (one hundred thousands position).
 - g. Press **INCREMENT** until 7 is displayed. Press **ENTER/STEP** to confirm the entry of the divisor.

Enter the calculated divisor.

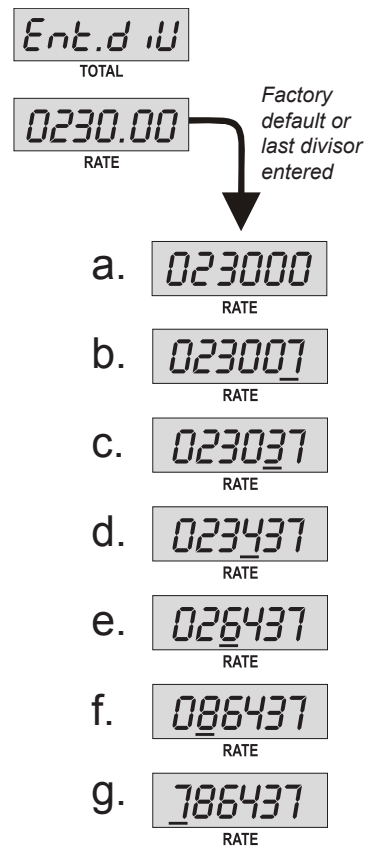

Underline denotes the flashing digit to be changed.

Set unit of measure for RATE.

Factory default setting is bpd.

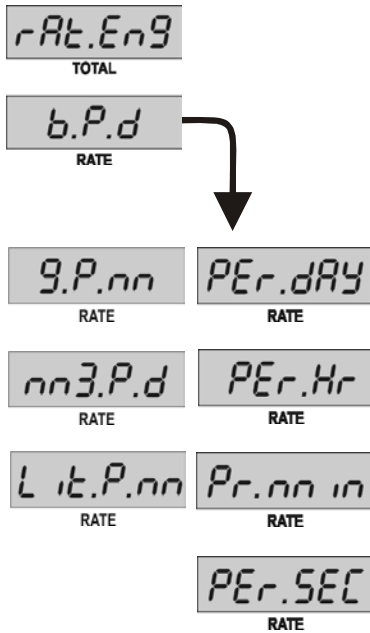

Deselect the Pulse Output option.

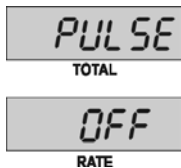

Deselect the Password Security option.

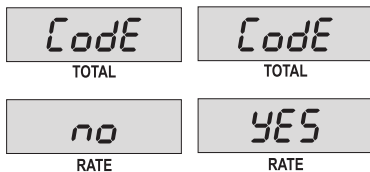

5. The upper display will show **rAt.Eng**, prompting you to enter the unit of measure for the flow rate. Press **INCREMENT** repeatedly until “per day” (**PER.dAY**) appears in the lower display. Since the desired rate is kiloliters per day, this is the appropriate rate setting for the user-defined volume unit. Press **ENTER/STEP**.
6. The upper display will show the prompt **PULSE** and the lower display will show the factory default setting, **OFF**. If it shows a setting other than **OFF**, press **INCREMENT** until **OFF** is shown since the pulse output is to be disabled. Press **ENTER/STEP**. (See Appendices A and B for information on configuring the pulse output feature.)
7. The upper display will show the prompt **Code** and the lower display will show **no**. Press **ENTER/STEP** to accept the factory default **no** setting, disabling the security code feature. If **YES** is displayed in the lower display, press **INCREMENT** until **no** is shown. (See “Enable Password Security Option,” page 11, for more information on security settings. Press **ENTER/STEP**.

- The prompt **SEt.tot** will appear in the top display, and **no** (default setting) will appear in the lower display.

Since no preprogrammed unit is to be entered for this example, press **ENTER/STEP** to bypass this menu selection.

The prompt **SAVing** will appear in the lower display while the calibration settings are saved to nonvolatile memory and the MC-II automatically returns to the Run mode.

- In Run mode, press **DEC. POINT** to position the decimal point in the top (volume) display to show tenths.

Bypass the Preset Total option.

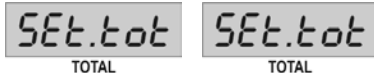

Example: Gas Measurement Using a Calculated Divisor

Calculating the divisor for gases is necessary when registering in units other than actual cubic feet (ACF). The **USER** volume and flow rate functions of the MC-II are used in this case.

Note—Each MC-II is shipped with a label set (Part No.100080190) containing commonly used flow rate and volume units of measure labels. The appropriate label can be placed on the front panel on the right side of the LCD viewing window.

Calibration Information

- A NuFlo 2-in. high-range gas turbine meter will be used to measure gas flow with an average flowing pressure of 120 PSIG and an average flowing temperature of 50°F.
- The meter factor is 72.56 pulses per actual cubic foot (PACF).
- The unit of measure for volume is to be cubic meters.
- The unit of measure for the flow rate is to be cubic meters per day.
- The standard conditions to compensate to are 60°F and 14.73 PSIA.
- The atmospheric pressure is unknown, but the elevation is 1,000 feet above sea level.

Calibration Procedure

1. Calculate the divisor and divisor decimal point position using the following equation:

$$Divisor = \frac{FC \times Ps \times Tf \times CON}{(Pg + Pa) \times Ts \times (Fpv)^2}$$

Where:

- FC = Meter calibration factor in pulses per actual cubic foot (PACF)
- Ps = Standard pressure in PSIA
- Tf = Average flowing temperature in degrees Rankine (°R)
- CON = Conversion factor for number of standard cubic feet (SCF) per unit volume of desired measure
- Pg = Average flowing pressure in PSIG
- Pa = Atmospheric pressure in PSIA
- Ts = Standard temperature in degrees Rankine (°R)
- Fpv = Supercompressibility factor (enter a factor of 1 if the supercompressibility factor is not known)

- a. Determine the supercompressibility factor. In this example, Fpv = 1.0102.
- b. Determine the average atmospheric pressure at 1000 feet above sea level (14.21 PSIA). Pa = 14.21 PSIA
- c. Determine the factor for converting Fahrenheit to Rankine (°R = °F + 459.67.)
 Flowing Temperature (Tf) = 50 F + 459.67 = 509.67°R
 Static Temperature (Ts) = 60 F + 459.67 = 519.67°R
- d. Determine the factor for converting cubic feet to cubic meters. There are 35.31 cubic feet per cubic meter; therefore, CON = 35.31.

- e. Substitute calculated values for variables in the formula to obtain the divisor.

$$\text{Divisor} = \frac{FC \times Ps \times Tf \times CON}{(Pg + Pa) \times Ts \times (Fpv)^2} = \frac{72.56 \times 14.73 \times 509.67 \times 35.31}{(120 + 14.21) \times 519.67 \times (1.0102)^2} = 270.2462$$

- f. Round the divisor to six digits (to accommodate the six-digit limit of the MC-II display). In this example, the divisor to be entered into the MC-II is 270.246.
2. Refer to “Example: Liquid Measurement with User-Defined Units of Measure, Steps 2 through 9, pages 20 through 23, for instructions on entering the divisor and other calibration data into the MC-II.

Maintenance

Recalibration

For maximum accuracy, recalibrate the MC-II when installing a new rotor and vane kit in the companion flowmeter, or when the MC-II is to be used with a flowmeter that has a different calibration factor. Changing the calibration of an MC-II does not affect the flow totals accumulated at the time of the calibration. Rather, additional flow, measured in accordance with the new calibration information, will be added to the existing total.

Battery Replacement

The battery used in the MC-II has a life expectancy of three to five years. This battery’s very flat discharge curve makes it difficult to measure voltage to determine the remaining battery life at any point in time. Record the date of installation on the new battery for future reference in determining when it should be replaced.

To replace the battery, perform the following steps:

1. If the existing battery is still functional, press **ENTER/STEP** to store the current volume in nonvolatile memory.



CAUTION: Before opening the enclosure, make sure the enclosure is in a well-ventilated area and avoid breathing fumes that could be trapped inside. Under normal operating conditions, the lithium battery that powers the MC-II is a sealed unit and poses no hazard when the enclosure is opened. However, a leak in a lithium battery could expel toxic fumes into the enclosure. If the battery appears to be damaged, adhere to the safety precautions and follow the disposal instructions provided in Appendix C.

2. Loosen the eight captive screws around the outer edge on the back of the enclosure. The front plate of the MC-II will fold down, hinging on the plastic retaining straps at the bottom of the enclosure. The battery and circuit board should now be exposed for servicing.

Note— If necessary, use a thin screwdriver blade to pry the front plate free, but do not use excessive force.

3. Disconnect the old battery from the circuit assembly and remove the battery from the housing.
4. Mount the new battery in the housing, and connect it to the circuit assembly.

Circuit Assembly Replacement

The circuit assembly (Part No. 100005109) contains all of the electronic components. To retain the current volume information for reentering into a new replacement unit, record the totalized volume and rate information before uninstalling the circuit assembly.



CAUTION: Before opening the enclosure, make sure the enclosure is in a well-ventilated area and avoid breathing fumes that could be trapped inside. Under normal operating conditions, the lithium battery that powers the MC-II is a sealed unit and poses no hazard when the enclosure is opened. However, a leak in a lithium battery could expel toxic fumes into the enclosure. If the battery appears to be damaged, adhere to the safety precautions and follow the disposal instructions provided in Appendix C.

To remove the circuit card, perform the following steps:

1. Loosen the eight captive screws around the outer edge on the back of the enclosure. The front plate of the MC-II will fold down, hinging on the plastic retaining straps at the bottom of the enclosure. The circuit board should now be exposed for servicing.
2. Remove the four screws located in the corners of the card.
3. Disconnect the battery, signal cable, and the switchplate.
4. Reconnect the battery, signal cable, and switchplate to the new circuit assembly..
5. Secure the new circuit assembly to the faceplate using four mounting screws.
6. Close the door of the enclosure and secure with eight captive screws around the outer edge of the back of the enclosure.



CAUTION: Use of spare parts other than those identified by Cameron's Measurement Systems Division voids CSA certification. Cameron bears no legal responsibility for the performance of a product that has been serviced or repaired with parts that are not authorized by Cameron.

BASIC MC-II SPARE PARTS LIST

| Quantity | Part Number | Description |
|----------|-------------|---|
| 1 | 100005118 | Switchplate/Frontplate Assembly |
| 1 | 100005109 | Circuit Assembly-Totalizer/Rate Indicator-LCD |
| 1 | 100005111 | Battery, Lithium, 3.6V |
| 1 | 100002605 | Desiccant Packet |
| 1 | 100005116 | 1 ft. Cable Assembly |
| 1 | 100005126 | Sponge Rubber Gasket |
| *1 | 100005117 | 10 ft. Cable Assembly |

* Required with remote mounting option.

ADDITIONAL SPARE PARTS LIST (FOR NON-INTRINSICALLY SAFE PULSE OUTPUT OPTION)

| Quantity | Part Number | Description |
|----------|-------------|--|
| 1 | 100005121 | Circuit Assembly, Pulse Output, Non-Intrinsically Safe |
| 1 | 100034876 | Relay, 5V |
| 1 | 100002361 | Relay, 12V |
| 1 | 100002551 | Relay, 24V |
| 1 | 100079680 | Module, Open Collector |
| 1 | 100007975 | Module, Opto-isolated |

ADDITIONAL SPARE PARTS LIST (FOR INTRINSICALLY SAFE PULSE OUTPUT OPTION)

| Quantity | Part Number | Description |
|----------|-------------|---|
| 1 | 100005163 | Circuit Assembly, 6 VDC, Pulse Output, Intrinsically Safe |
| 1 | 100034876 | Relay, 5V |
| 1 | 100079680 | Module, Open Collector |
| 1 | 100007975 | Module, Opto-isolated |
| 1 | 100035823 | Safety Barrier, Model 710+ |
| 1 | 100035824 | Safety Barrier, Model 760+ (relay option) |

Installing the Pulse Output Circuit Assembly

A 6-pin terminal strip and two mounting holes in the pulse output circuit assembly allow for easy installation.

To install the pulse output option, perform the following steps:

1. Confirm that the W1 jumper is set in the “Divide by 1” position. This setting allows you to configure the pulse output scale using the keypad on the front of the enclosure.
2. Route the field wiring through the cord connector in the enclosure.
3. Connect the wiring in accordance with Figures A2 (dry contact), A3 (open collector) and A4 (opto-isolated).

Selecting a Scale Factor

The scale factor that you enter into the MC-II sets the volume increment that will cause a pulse output to occur. The scale factors are:

| | |
|-------|--------------------------------------|
| 0.001 | One pulse per 0.001 volume increment |
| 0.01 | One pulse per 0.01 volume increment |
| 0.1 | One pulse per 0.1 volume increment |
| 1.0 | One pulse per 1 volume increment |
| 10.0 | One pulse per 10 volume increments |
| 100.0 | One pulse per 100 volume increments |

Configuring the Pulse Output Option

To use the pulse output option, you must enable the pulse output feature and enter a pulse output scale factor using the keypad menu, as described in the following steps:

1. Press and hold **ACCESS** for 3 seconds, then release, to enter the Calibrate mode (see Data Entry tip below).
2. Proceed through the various menu displays, pressing **ENTER/STEP** to advance to the next menu, until the prompt **PULSE** appears in the top display. The default setting is **OFF**.
3. Press **INCREMENT** to select the appropriate scale factor (0.001, 0.01, 0.1, 1.0, 10.0, 100.0). The scale factor is the volume increment that will cause a pulse output to occur.
4. Press **ENTER/STEP** to accept the selection. The **Code** menu will appear in the top display.
5. Press **ENTER/STEP** to accept the existing **Code** setting, or change the password security setting and then press **ENTER/STEP**. The **Set.tot** menu (for presetting a total) will appear in the top display.
6. Press **ENTER/STEP** to bypass this menu selection or press **INCREMENT** to enable the preset total option. (See step 7 of the calibration procedure on page 16 for details on presetting a total.)

The prompt **SAVing** will appear in the lower display while the calibration settings are saved to nonvolatile memory. The MC-II will automatically return to the Run mode.

Data Entry Tip

To retain a numerical calibration setting and advance to the next menu without pressing **ENTER/STEP** repeatedly, press and hold **ACCESS** for 3 seconds, then release. This shortcut applies only to numerical fields. You must press **ENTER/STEP** to select all other entries.

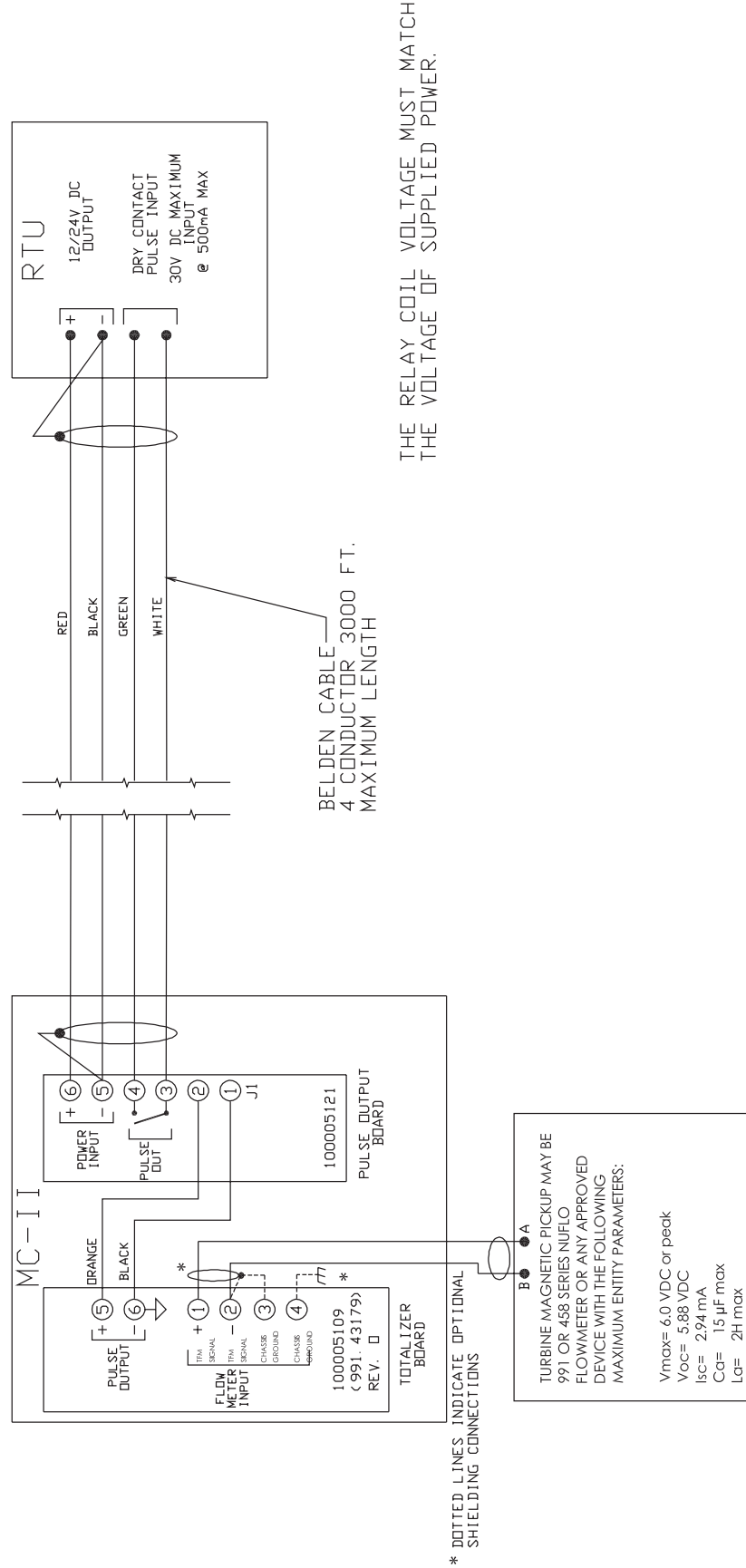

Figure A2—Field wiring for dry contact pulse output option (non-hazardous areas)

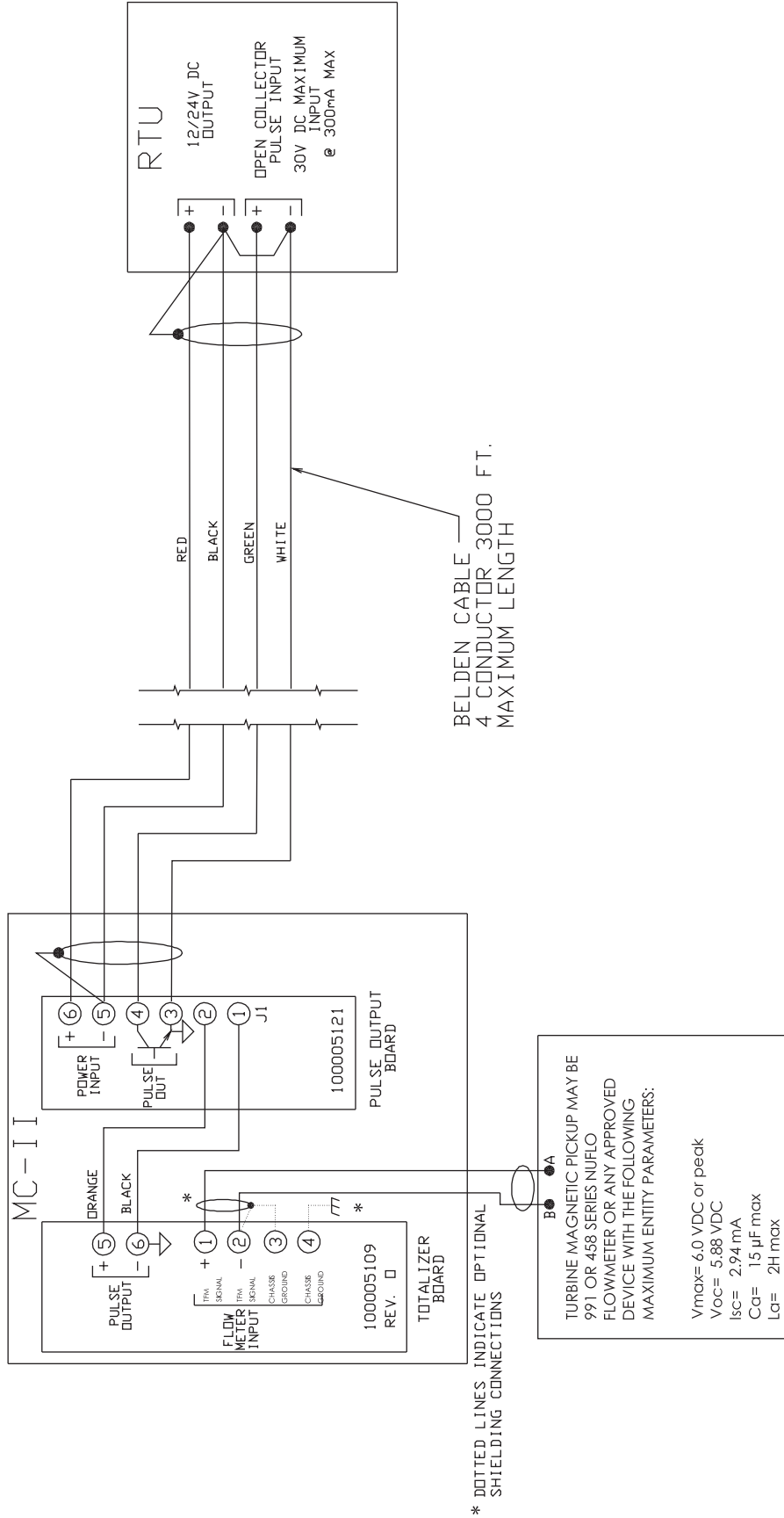

Figure A3—Field wiring for open collector pulse output option (non-hazardous areas)

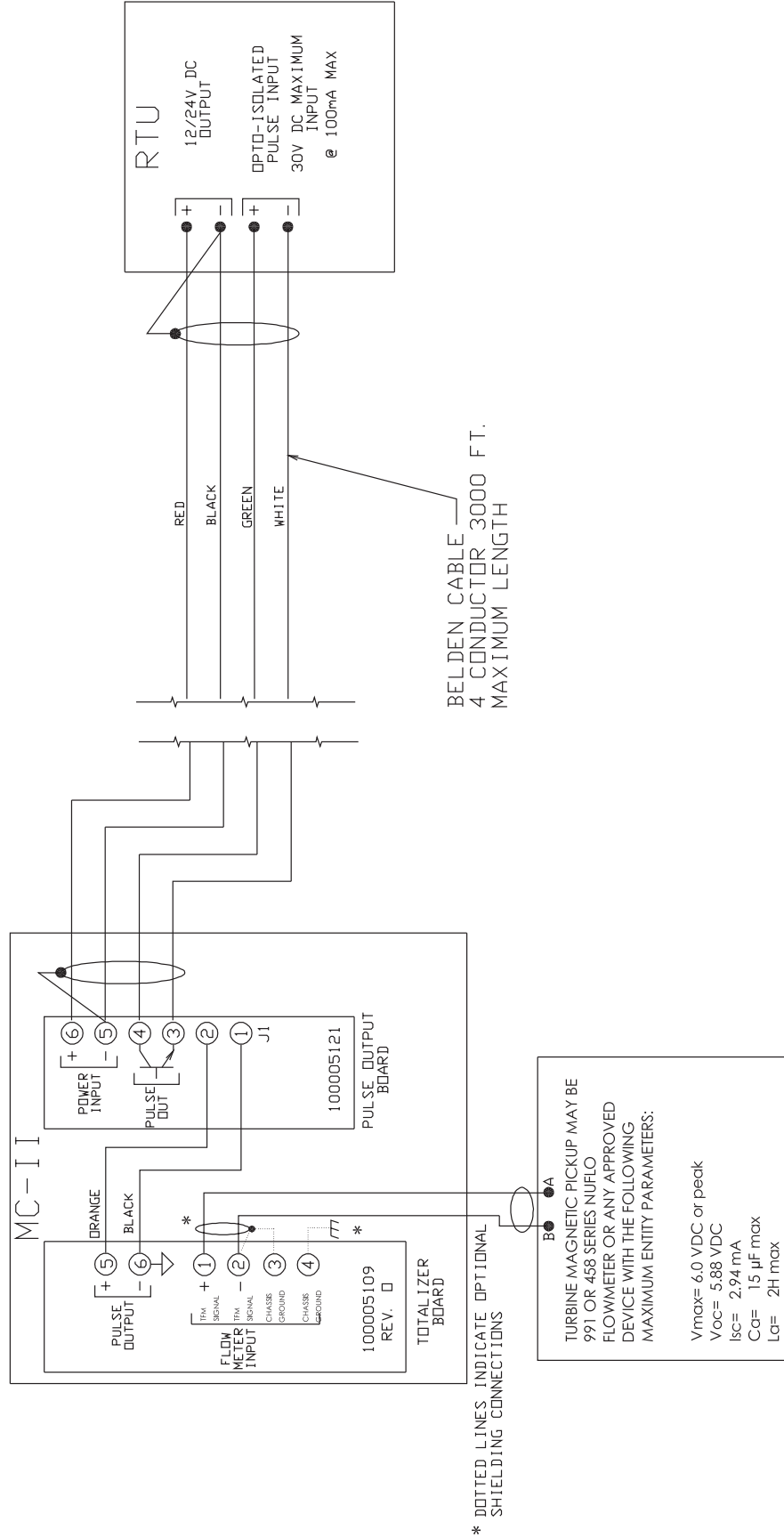

Figure A4—Field wiring for opto-isolated pulse output option (non-hazardous areas)

Appendix B—Pulse Output Option, Intrinsically Safe

MC-II Pulse Output Circuit Assembly (Part No. 100005163; Intrinsically Safe)

The pulse output circuit assembly (Figure B1) equips the MC-II Flow Analyzer to provide an optional pulse output. It is mounted inside the unit between the totalizer board and the battery cavity.

Important—When this circuit assembly is installed according to Figures B2, B3 and B4 (pages 35 and 36), the MC-II with pulse output is rated by Canadian Standards Association as Intrinsically Safe for Class I, Division 1, Groups A,B,C and D.

Pulse Input - Intrinsically Safe

The pulse input to this card is obtained from the “Pulse Out” of the totalizer card. It will appear in the form of a square wave pulse.

Pulse Output - Intrinsically Safe

The pulse output from this card is provided in the form of a dry contact from a relay, transistor open-collector, or an emitter/collector opto-isolated output. A 14-pin socket on the card is provided to install either the relay or component plug “module”, whichever is specified.

Electrical Specifications - Intrinsically Safe

| | |
|-----------------------|------------------|
| Current Required | 10 mA |
| Relay Contact Rating | 200 mA, 6 VDC |
| Open Collector Module | 200 mA, 6 VDC |
| Opto-Isolated Module | 100 mA, 6 VDC |
| Pulse Output Duration | 60 msec (approx) |

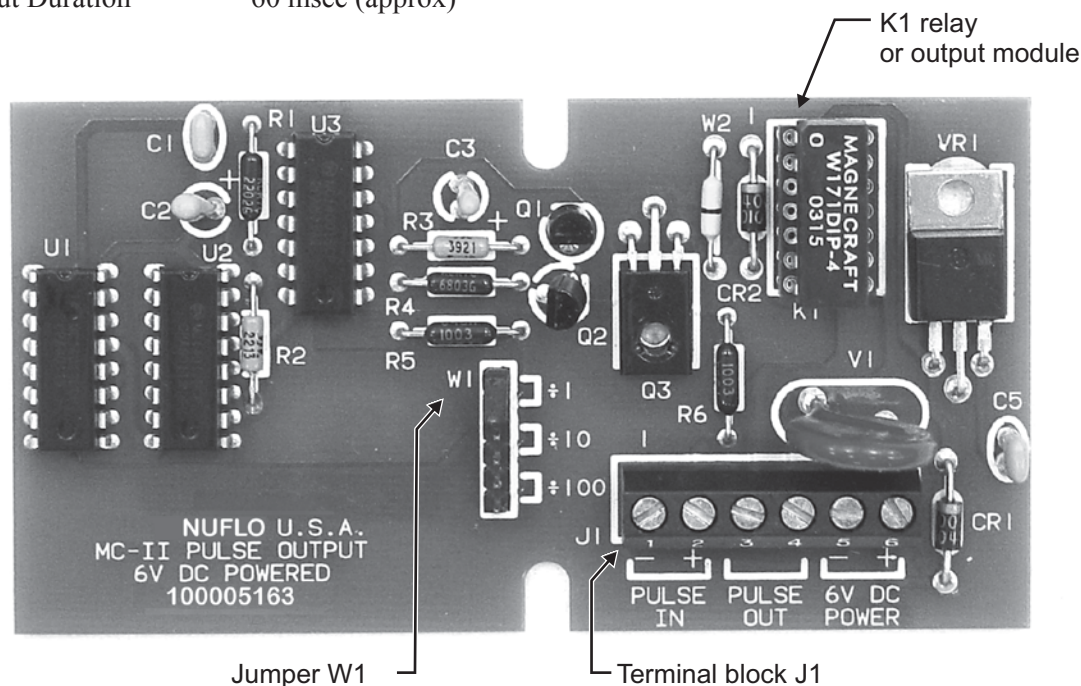

Figure B1—Pulse output circuit assembly, intrinsically safe (Part No. 100005163 / 991.44828)

Installing the Pulse Output Circuit Assembly

A 6-pin terminal strip and two mounting holes in the pulse output circuit assembly allow for easy installation.

To install the pulse output option, perform the following steps:

1. Confirm that the W1 jumper is set in the “1” position. This setting allows you to configure the pulse output scale using the keypad on the front of the enclosure.
2. Route the field wiring through the supplied cord connector or the enclosure.
3. Connect the wiring in accordance with Figure B2.

Choosing a Scale Factor

The scale factor that you enter into the MC-II sets the volume increment that will cause a pulse output to occur. The scale factors are:

| | |
|-------|--------------------------------------|
| 0.001 | One pulse per 0.001 volume increment |
| 0.01 | One pulse per 0.01 volume increment |
| 0.1 | One pulse per 0.1 volume increment |
| 1.0 | One pulse per 1 volume increment |
| 10.0 | One pulse per 10 volume increments |
| 100.0 | One pulse per 100 volume increments |

Configuring the Pulse Output Option

To use the pulse output option, you must enable the pulse output feature and enter a pulse output scale factor using the keypad menu, as described in the following steps:

1. Press and hold **ACCESS** for 3 seconds, then release, to enter the Calibrate mode (see Data Entry tip below).
2. Proceed through the various menu displays, pressing **ENTER/STEP** to advance to the next menu, until the prompt **PULSE** appears in the top display. The default setting is **OFF**.
3. Press **INCREMENT** to select the appropriate scale factor (0.001, 0.01, 0.1, 1.0, 10.0, 100.0). The scale factor is the volume increment that will cause a pulse output to occur.
4. Press **ENTER/STEP** to accept the selection. The **Code** menu will appear in the top display.
5. Press **ENTER/STEP** to accept the existing **Code** setting, or change the password security setting and then press **ENTER/STEP**. The **Set.tot** menu (for presetting a total) will appear in the top display.
6. Press **ENTER/STEP** to bypass this menu selection or press **INCREMENT** to enable the preset total option. (See step 7 of the calibration procedure on page 16 for details on presetting a total.)

The prompt **SAVing** will appear in the lower display while the calibration settings are saved to nonvolatile memory. The MC-II will automatically return to the Run mode.

Data Entry Tip

To retain a numerical calibration setting and advance to the next menu without pressing **ENTER/STEP** repeatedly, press and hold **ACCESS** for 3 seconds and release. This shortcut applies only to numerical fields. You must press **ENTER/STEP** to select all other entries.

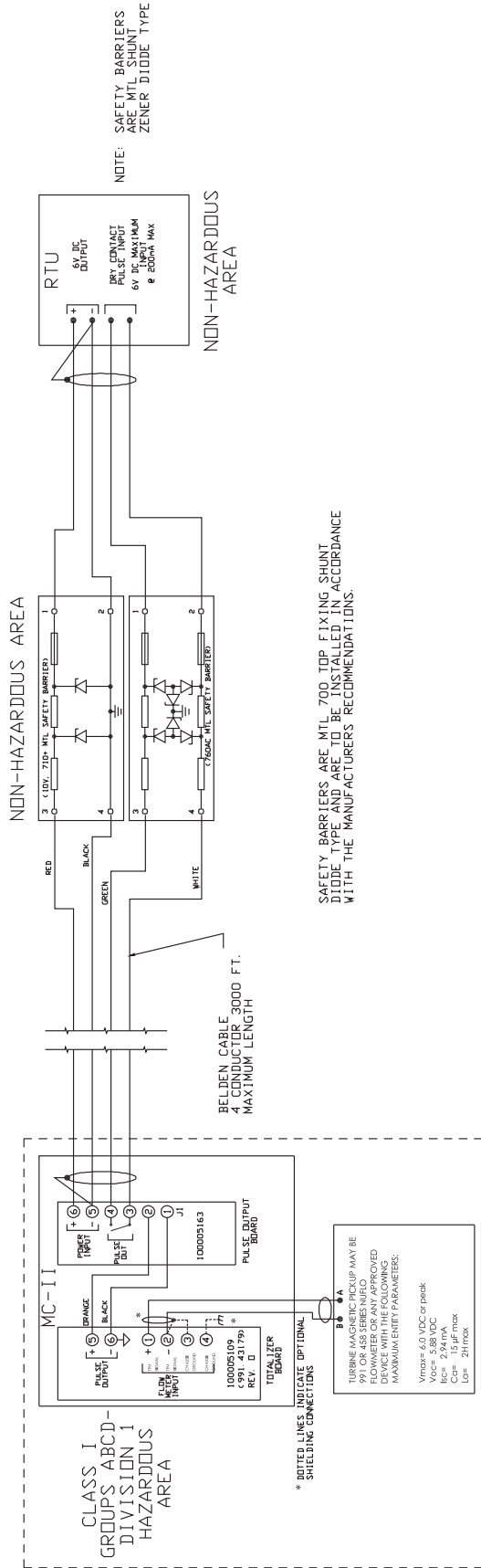

Figure B2—Field wiring for dry contact pulse output option (MC-II Flow Analyzer is CSA-approved for use in HAZARDOUS areas when installed in accordance with drawing 101231210 shown above)

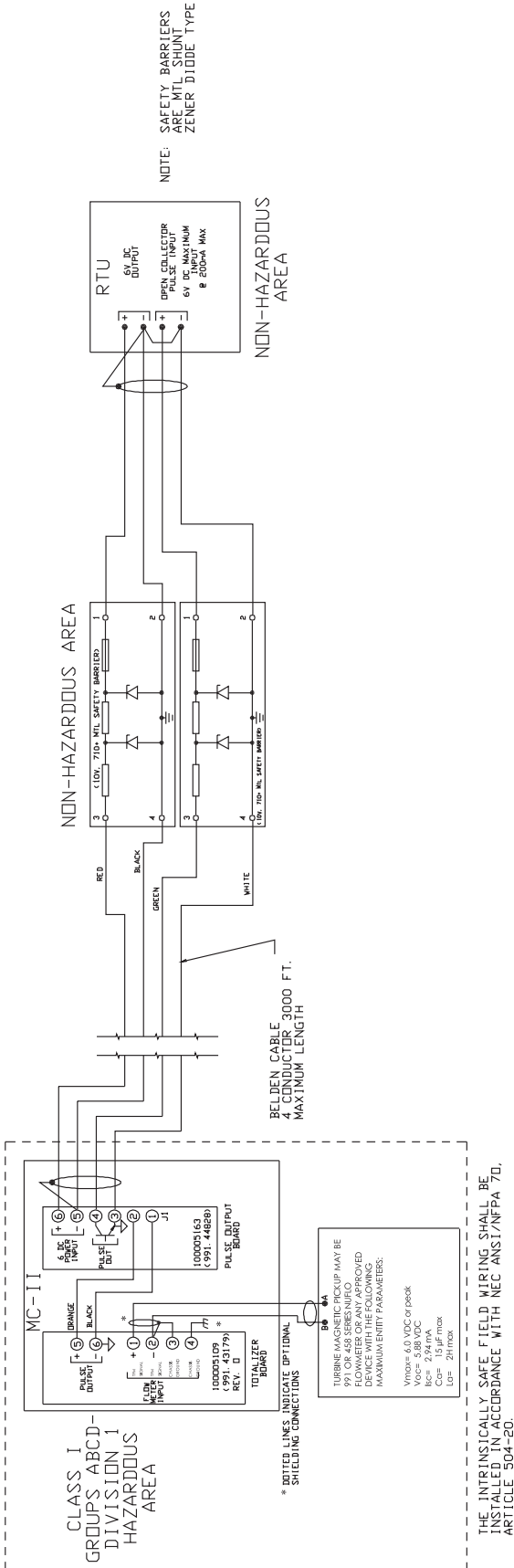

Figure B3—Field wiring for open collector pulse output option (MC-II Flow Analyzer is CSA-approved for use in HAZARDOUS areas when installed in accordance with drawing 101231210 shown above)

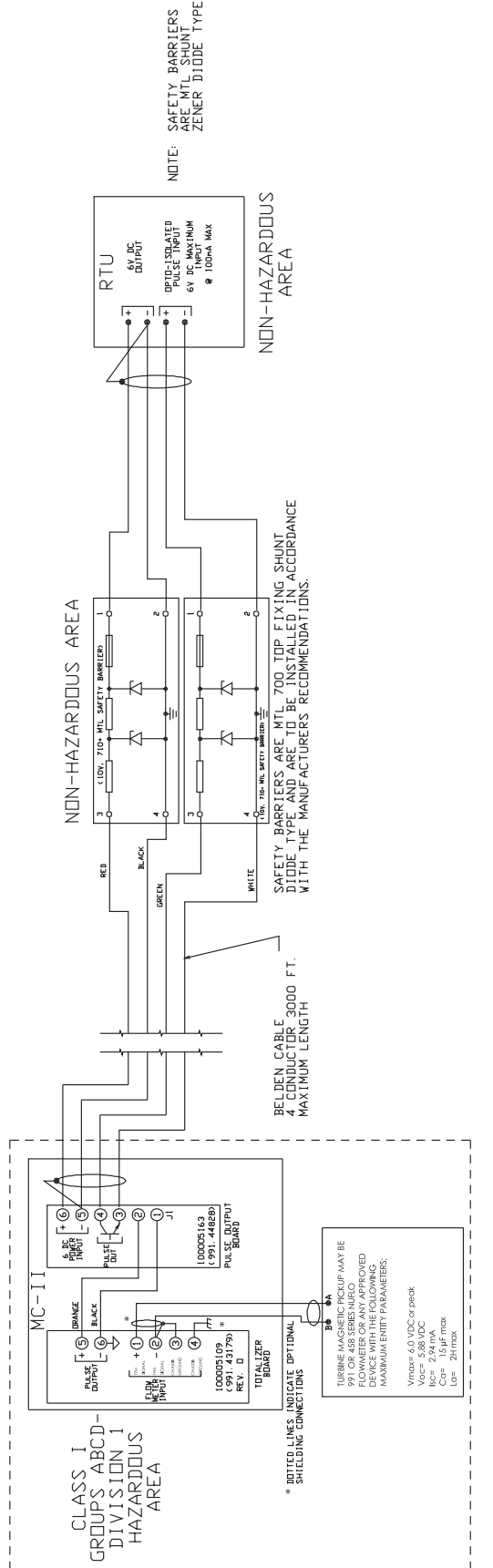

Figure B4—Field wiring for opto-isolated pulse output option (MC-II Flow Analyzer is CSA-approved for use in HAZARDOUS areas when installed in accordance with drawing 101231210 shown above)

Appendix C—Lithium Battery Information

Lithium Battery Disposal

Once a lithium battery is removed from a device and/or is destined for disposal, it is classified as solid waste under EPA guidelines. Depleted lithium batteries are also considered to be hazardous waste because they meet the definition of Reactivity, as per 40 CFR 261.23(a)(2), (3) and (5). This document describes how the lithium reacts violently with water, forms potentially explosive mixtures with water, and when exposed to certain pH conditions, generates toxic cyanide or sulfide gases.

Federal law requires that depleted lithium batteries be sent to a fully permitted Treatment, Storage and Disposal Facility (TSDF) or to a permitted recycling/reclamation facility.

Important: Do not ship lithium batteries to Cameron’s Measurement Systems Division. Cameron facilities are not permitted recycling/reclamation facilities.



Caution: Profiling and waste characterization procedures must be followed prior to shipping a lithium battery to a disposal site. It is the shipper’s responsibility to comply with all applicable federal transportation regulations (see below).

Transportation Information



Warning: The MC-III EXP flow analyzer contains lithium batteries. The internal component (thionyl chloride) is hazardous under the criteria of the Federal OSHA Hazard Communication Standard 29 CFR 1920.1200. Before shipping a lithium battery or equipment containing a lithium battery, verify that the packaging and labeling conforms with the latest version of all applicable regulations.

The transport of the lithium batteries is regulated by the United Nations, “Model Regulations on Transport of Dangerous Goods,” (special provisions 188, 230, and 310), latest revision.

Within the US the lithium batteries and cells are subject to shipping requirements under Part 49 of the Code of Federal Regulations (49 CFR, Parts 171, 172, 173, and 175) of the US Hazardous Materials Regulations (HMR), latest revision.

Shipping of lithium batteries in aircraft is regulated by the International Civil Aviation Organization (ICAO) and the International Air Transport Association (IATA) requirements in Special Provisions A45, A88 and A99, latest revision.

Shipping of lithium batteries on sea is regulated the International Maritime Dangerous Goods (IMDG) requirements in special provisions 188, 230 and 310, latest revision.

Shipping of lithium batteries on road and rail is regulated by requirements in special provisions 188, 230 and 310, latest revision.

WARRANTY - LIMITATION OF LIABILITY: Seller warrants only title to the products, software, supplies and materials and that, except as to software, the same are free from defects in workmanship and materials for a period of one (1) year from the date of delivery. Seller does not warranty that software is free from error or that software will run in an uninterrupted fashion. Seller provides all software "as is". THERE ARE NO WARRANTIES, EXPRESS OR IMPLIED, OF MERCHANTABILITY, FITNESS OR OTHERWISE WHICH EXTEND BEYOND THOSE STATED IN THE IMMEDIATELY PRECEDING SENTENCE. Seller's liability and Buyer's exclusive remedy in any case of action (whether in contract, tort, breach of warranty or otherwise) arising out of the sale or use of any products, software, supplies, or materials is expressly limited to the replacement of such products, software, supplies, or materials on their return to Seller or, at Seller's option, to the allowance to the customer of credit for the cost of such items. In no event shall Seller be liable for special, incidental, indirect, punitive or consequential damages. Seller does not warrant in any way products, software, supplies and materials not manufactured by Seller, and such will be sold only with the warranties that are given by the manufacturer thereof. Seller will pass only through to its purchaser of such items the warranty granted to it by the manufacturer.

MEASUREMENT SYSTEMS *Formerly NuFlo Measurement Systems*

NORTH
AMERICA:

1.800.654.3760

ms-us@c-a-m.com

ASIA
PACIFIC

65.6737.0444

ms-asiapacific@c-a-m.com

EUROPE, MIDDLE EAST
& AFRICA

44.1243.826741

ms-uk@c-a-m.com

HOUSTON HEAD OFFICE: 281.582.9500 • www.c-a-m.com/flo

USA: Houston, TX • Corpus Christi, TX • Kilgore, TX • Odessa, TX • Dallas, TX • Tulsa, OK
Duncan, OK • Broomfield, CO • Bakersfield, CA • Shreveport, LA • Lafayette, LA
Houma, LA • Pittsburgh, PA • Laurel, MS • Saginaw, MI • Casper, WY • Charleston, WV

CANADA: Calgary, AB • Edmonton, AB

INTERNATIONAL: Aberdeen, Scotland • Beijing, China • Bognor Regis, UK
Dubai, UAE • Hassi Messaoud, Algeria • Jakarta, Indonesia • Singapore