



Powering Business Worldwide

# CCS 4

## Contamination Control System

Particle counting + Water saturation + Temperature



## *Instruction manual*

# Version 1.8

Serial-no. CCS 4: .....

Version valid from: 30.08.2013

## Index

	page
<b>1. SAFETY INFORMATION</b>	<b>4</b>
1.1. Signal glossary.....	4
1.2. Dangers of maloperation .....	4
1.2.1. Hazards by working at the hydraulic or lubrication system .....	5
1.2.2. When all measurements are done: .....	6
1.3. Sources of danger.....	6
1.4. Service staff.....	6
1.5. Safety arrangements on site .....	6
1.6. Intended applications .....	6
1.6.1. Limitation of use .....	7
1.6.1.1. Visual inspection of the used fluid .....	7
<b>2. OPERATION AND INSTALLATION</b>	<b>8</b>
2.1. Setup.....	8
2.2. General information .....	8
2.3. Connection to the hydraulic or lubricating system .....	9
2.3.1. Connection into the pressure operating mode (max. 420 bar).....	9
2.3.2. Connection into the suction operating mode (min. -0, 2 bar) .....	10
2.4. Electrical connection .....	10
2.4.1. Mains operation .....	10
2.4.2. Battery operation .....	11
2.5. Usage of the CCS 4 software.....	12
2.5.1. Changing the operator language.....	12
2.5.2. Changing to the demo mode.....	13
2.5.3. Key pad .....	14
2.5.4. Main menu.....	15
2.5.4.1. On-line particle counting.....	16
2.5.4.1.1. Measure-type: On-line single.....	18
2.5.4.1.2. Measure-type: On-line continuous .....	20
2.5.4.1.3. Measure-type: On-line cyclic.....	23
2.5.4.2. Off-line Particle Counting .....	25
2.5.4.3. File system.....	31
2.5.4.3.1. Display of the average (Off-line mode) .....	34
2.5.4.4. Data transfer .....	35
2.5.4.4.1. Transfer of the saved data by RS232 .....	35
2.5.4.4.2. Data transfer of the saved data as TXT-file via USB.....	43
2.5.4.4.2.1. Data transfer from the USB – stick to the computer by using the data manager software.....	45
2.5.4.4.3. Continuous transfer of the current measurement values.....	50
2.5.4.4.3.1. HyperTerminal .....	50
2.5.4.4.3.2. Definition of the data transfer rate .....	50
2.5.4.4.3.3. Procedure .....	51
2.5.4.4.3.4. Protocol of the continuous data transfer .....	52

2.5.4.5.	Data file delete and setting of date/ time .....	54
2.5.4.5.1.	Delete files.....	54
2.5.4.5.2.	Date/ time .....	55
<b>2.6.</b>	<b>Printer .....</b>	<b>56</b>
2.6.1.	Installation of new paper rolls .....	56
<b>2.7.</b>	<b>Set up of the HyperTerminal.....</b>	<b>57</b>
<b>2.8.</b>	<b>Installation of the Data Manager Software at an external PC.....</b>	<b>58</b>
2.8.1.	One-time program installation.....	58
<b>2.9.</b>	<b>CCS 4 - software update (filelink).....</b>	<b>58</b>
<b>3.</b>	<b><u>EVALUATION OF MEASUREMENT RESULTS</u> .....</b>	<b>60</b>
<b>3.1.</b>	<b>Water sensor .....</b>	<b>60</b>
3.1.1.	Display in % water saturation.....	60
3.1.2.	Display of the fluid type and ppm water content.....	60
<b>4.</b>	<b><u>CALIBRATION</u> .....</b>	<b>61</b>
<b>5.</b>	<b><u>APPENDIX</u> .....</b>	<b>62</b>
<b>5.1.</b>	<b>Technical data .....</b>	<b>62</b>
<b>5.2.</b>	<b>Hydraulic plan .....</b>	<b>64</b>
<b>5.3.</b>	<b>Measurement principle .....</b>	<b>64</b>
5.3.1.	Laser sensor – PFS 01 .....	64
5.3.1.1.	8 – channel particle counting.....	65
5.3.2.	Water sensor .....	65
<b>5.4.</b>	<b>Overview of the data storage and measurement results.....</b>	<b>66</b>
<b>5.5.</b>	<b>Cleanliness classes according to ISO 4406:99 .....</b>	<b>67</b>
<b>5.6.</b>	<b>Cleanliness classes according to NAS 1638.....</b>	<b>68</b>
<b>5.7.</b>	<b>Cleanliness classes according to SAE AS 4059 .....</b>	<b>69</b>
<b>5.8.</b>	<b>Fields of application – compatibility .....</b>	<b>70</b>
<b>5.9.</b>	<b>Trouble shooting.....</b>	<b>70</b>
<b>5.10.</b>	<b>Shipment, parts list.....</b>	<b>70</b>

# 1. Safety information

## 1.1. Signal glossary

- Failure to observe the safety instructions in this manual implies various risks and endangerment of life and the physical condition of the operator. The notices are marked with the following **signal words**:



**DANGER** implies a dangerous situation which **causes death or serious injuries** in case of nonobservance.



**WARNING** implies a dangerous situation which can **cause death or serious injuries** in case of nonobservance.



**CAUTION** implies, together with the danger symbol, a dangerous situation which can **cause light, medium, or heavy injuries** in case of nonobservance.

- Failure to observe the safety instructions in this manual, which does not cause injuries but destruction of the system and its operability, are marked with the following signal word:



**NOTICE** describes the correct way of handling the device.

The above signal words can be combined with the safety symbols or the warning symbols.



General danger



Danger caused by electricity







Danger for the environment

## 1.2. Dangers of maloperation

The CCS 4 underwent a safety inspection. The integrated electric and hydraulic safety elements ensure safe operation if the device is used as it is intended.



In cases of maloperation or abuse, as well as in cases of ignoring the application limits and safety regulations, the following threats can occur regarding the:

- Life or physical condition of the operator; 
- The **CCS 4** device, as well as connected machines and systems; 
- The accuracy of measurements made by the **CCS 4**; 
- The environment. 



**Therefore, it is necessary that everybody having to do with the operation and the maintenance of the unit strictly follows this instruction manual!**

## 1.2.1. Hazards by working at the hydraulic or lubrication system

May occur the following hazards:

- uncontrolled discharge of the pressure fluids
- accidental machine movements
- thrown or bursting of parts
- skin toxicity
- noise emission

### Uncontrolled discharge of the pressure fluids

Possible leaking of the hydraulic fluid:

In case of breakage of pipes, upon release of fasteners that are still pressurized, damages of the hydraulic hose lines or by exposure to excessively high forces.

The consequences can be:

- eye damage
- skin penetration
- fire hazard
- risk of slipping
- environmental hazards, such as penetration of the fluid into the soil / groundwater

Connection of the hoses from the CCS 4 to the hydraulic or lubrication system, see chapter 2.3.

### Accidental machine movements

- Accidental operation of command or control devices. (buttons, levers, proximity switches, and so on)
- Error in control
- Failure of components due to for example: excessive system pressure, material fatigue...
- Contamination of the hydraulic fluid

### Thrown or bursting of parts

May be a result of:

- excessive stress of components (eg: high operating pressures or pressure peaks)
- material fatigue (eg: demolished hydraulic hose assemblies)

### Skin toxicity

- Through contact with hydraulic fluids. **⚠ WARNING Follow the skin protection plan!**
- Vapors of pressure fluids can cause respiratory irritation, if inhaled.

### Noise emission by

- pump units
- the work process noise generated by machines

**⚠ WARNING Use hearing protection at hazardous noise levels.**

**NOTICE** One or more hazards can occur simultaneously depending on maintenance work. Accordingly, several safeguards must be applied.

- **Note the five-finger rule of fluid technology during maintenance work!**
  1. Separate power supply
  2. Secure against re-supply
  3. Depressurized the system (also the pressure storage), lowering or supporting of the uphold loads, reduce residual energy
  4. Check the release pressure (pressure free)
  5. Prevent hazards by neighboring plants.

### 1.2.2. When all measurements are done:

1. Switch **OFF** the CCS 4 and disconnect the external power supply.
2. **Disconnect** the **pressure hose or suction hose** (depending on the hydraulic connection).
3. **(at last!) Disconnect the return hose** (transparent plastic hose) from the **[OUTLET PORT]** of the CCS 4.

### 1.3. Sources of danger

- An operation of the CCS 4 is only allowed at a shockproof socket.
- **▲ WARNING** Avoid the risk of direct and indirect contact with voltage- or current-carrying parts. Voltage disappearances, e.g.: avoid due to poor grounding.

### 1.4. Service staff

- Only authorized persons are allowed to work with the CCS 4.

The operator has to:

- hand over the maintenance instruction to the user.
- make sure, that the user reads and understands the instruction.

### 1.5. Safety arrangements on site

- The CCS 4 has to sit on a flat solid ground.
- For outdoor measurements (in the rain) use the CCS 4 only with tilted housing cover. This prevents the entry of water into the CCS 4.

**NOTICE** Look at the hoses, while closing the housing cover!

### 1.6. Intended applications

- The CCS 4 is a mobile diagnostic system meant for continuous monitoring and condition analyses of hydraulic and lubricating systems, which enables the user to evaluate the up-to-date condition by measuring the particle contamination, water saturation and temperature.
- The particle size distribution is being shown in contamination classes according to ISO 4406:99, NAS 1638 and SAE AS 4059.
- Resulting out of measured saturation and temperature values, the theoretical water content in ppm (mg/kg) is being calculated and displayed for selected fluids.
- By knowing these important parameters the user is able to evaluate the precise condition of the system. Having this information will help to initiate actions promptly and cost-saving measures before major failures can occur.
- The unit is suitable for pressure, as well as for suction operation, i.e. it can be connected to a pressure line by a minimess connection or absorb fluids which are to be analyzed by using an integrated suction pump.

## 1.6.1. Limitation of use

The device is exclusively adequate for on-line applications in hydraulic and lubricating systems within the following limitations:



- operation pressure (suction port):  $p = -0,2...40 \text{ bar}$  (-2,9...580 PSI)
- operation pressure (pressure port):  $p = 1,5...420 \text{ bar}$  (21,75...6090 PSI)
- viscosity range:  $v = 10...400 \text{ mm}^2/\text{s}$  (46,35...1854 SUS)
- temperature range of the oil:  $0...70 \text{ }^\circ\text{C}$  (32...158°F)
- ambient temperature range:  $0...50 \text{ }^\circ\text{C}$  (32...122°F)

### 1.6.1.1. Visual inspection of the used fluid

- If extremely contaminated fluid is introduced to the CCS 4, the internal orifices of the laser sensor can be blocked and display an anomalous result, e.g.: 00/ 00/ 00. (see chapter 5.3 of the instruction manual)  
Classification of highly contaminated fluids:
  - More than 24.000 parts per ml (>NAS 10 or class 22 acc. to ISO 4406:99)
  - Particles larger than 200  $\mu\text{m}$  (which can be detected without laboratory microscope)
- If the **laser sensor is blocked** (i.e. stalls in flushing mode or low fluid ISO classification), please take the following steps:
  - Attempt to **flush** the system with **clean** (NAS 4 or **ISO 16/13/9 or better**) **low viscosity fluid** (ISO VG 22) in the **continuous mode**.
  - If this **does not help**, please **contact** the **Eaton Technologies GmbH** representative or **send** the CCS 4 to the Eaton Technologies GmbH service center in Altlußheim.

**⚠ WARNING** The regular function of the CCS 4 and the warranty of safety are guaranteed only if it is used with provided and allowed accessories of Eaton Technologies GmbH.

- Before measuring with the CCS 4, the oil has to be extracted from the system and visually examined for extremely large particles that may cause undue wear to the system.
- **⚠ CAUTION**  Before connecting the CCS 4 to the system, make sure that the oil discharged out of the CCS 4 gets caught in a tank. The oil must not get released to the environment!

**⚠ DANGER**   No unauthorized modifications or changes are allowed to the CCS 4! E.g.: open the unit by removing the front screws and remove the assembly.

**NOTICE** The terms and conditions stated in this instruction manual have to be followed strictly!

## 2. Operation and installation

### 2.1. Setup

The CCS 4 consists of the equipment case (1), the external power supply (2), the RS232 – interface cable inclusive the USB – plug adaptor (3), high pressure measuring hose (minimess hose) (4), the suction hose and the return hose (5).

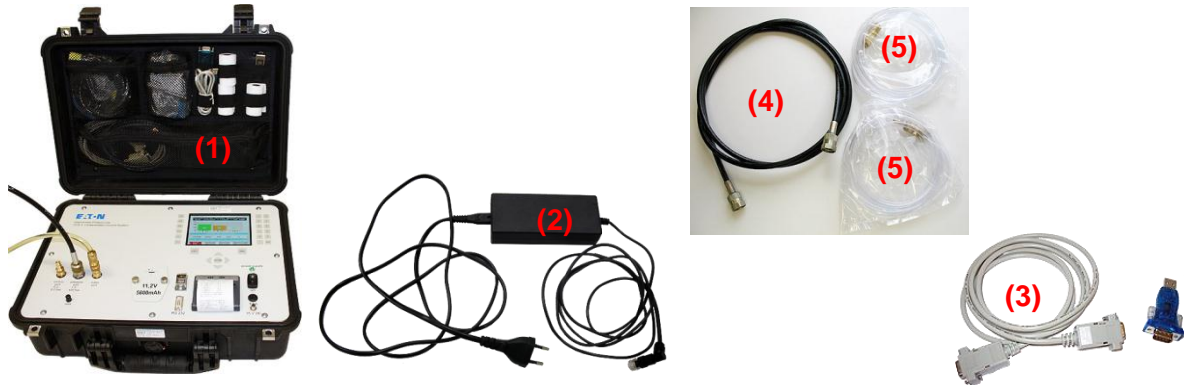

### 2.2. General information

External factors have a huge and extensive influence on the lubricant during operation. External factors are for example forces, energies, and interactions with other materials. Pressure and shear stress also belong to the force effects. Energy influences are the supply and the removal of heat (high temperature amplitudes). A lubricant gets in contact with gases (air, nitrous gases or sulphur dioxide), liquids (water, external liquids like detergents, dissolver etc.) and solid matters (metals, ceramics, synthetic material parts and sealing materials). The contamination outcomes are very versatile for the hydraulic and lubricating system and cause a significantly higher abrasion, an increase of the failure risk of components as well as malfunctions.

The CCS 4 is for the continuous monitoring and condition analyses of hydraulic and lubricating systems. The CCS 4 can be handled in suction as well as in pressure operating mode.

The CCS 4 includes the following functions:

- Particle counting by a laser sensor for hydraulic and lubrication oils within the measuring range < 24000 particle/ 1 ml and the maximum particle size of < 200 µm.
- Exact evaluation of contamination classes according to ISO 4406:99, NAS 1638 and SAE AS 4059.
- Measuring of.
  - Water saturation (0 ... 100%)
  - Temperature (0 ... 70 °C)(see also the technical data at chapter 5.1 )
- Calculation and output of the theoretical water content in ppm (mg/kg) based on fluid specific saturation curves.
- Display of all measurement values on a LCD display.
- Output of current measurement values by a RS232-interface.
- Output of current measurement values by using a thermal printer.
- Internal storage of measurements. (Storage capacity of 4 x 100 measurements.)
- Output of saved measurement files by USB-interface on the USB-stick.
- Output of saved measurement data by a RS232 – interface.  
For the data management using an external computer and the LabVIEW Data Manager Software (export in MS EXCEL).



## 2.3. Connection to the hydraulic or lubricating system

- The CCS 4 can be handled in a **suction** as well as in a **pressure operating mode**.

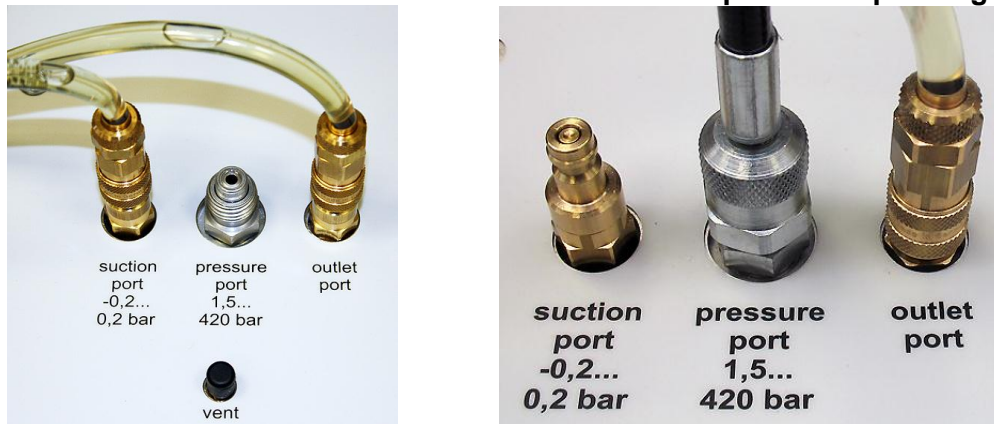

- Connections from the left to the right:  
suction port, pressure port and outlet port for the return line.

### NOTICE

Use only the labeled hoses, that supplied by Eaton.

Check the hoses before using.

Also check the cleanliness of the ports at the CCS 4, the hydraulic system and the hoses.

The ports must be cleaned before using, if they are contaminated by dust/ dirt and so on.

### 2.3.1. Connection into the pressure operating mode (max. 420 bar)

- Connect the return hose (transparent plastic hose) with the [OUTLET PORT] of the CCS 4 and transfer it to an oil collecting tank.

### CAUTION

- The oil collecting tank must be dimensioned according to the time needed to perform the operation. Otherwise you must provide an empty replacement tank that may be quickly changed when the first one is full.

- You may also circulate the measured oil back to the tank of the system.

- NOTICE** Never connect the recirculation to a pressurized line!



- In the **pressure operating mode** the provided high pressure hose (minimesh hose) is being connected with the CCS 4 - [PRESSURE PORT] and the hydraulic system.

## 2.3.2. Connection into the suction operating mode (min. -0, 2 bar)

- Connect the return hose (transparent plastic hose) with the [OUTLET PORT] of the CCS 4 and transfer it to an oil collecting tank.



- The oil collecting tank must be dimensioned according to the time needed to perform the operation. Otherwise you must provide an empty replacement tank that may be quickly changed when the first one is full.
- You may also circulate the measured oil back to the tank of the system.
- **NOTICE** Never connect the recirculation to a pressurized line!



- In the **suction operating mode** the provided suction hose (transparent PVC-hose) is being connected with the [SUCTION PORT] of the CCS 4 using the quick lock coupling (two-sided locking).
- The hose has to be inserted into the tank.

**NOTICE** Pay attention to create a distance of minimum 15 cm from the tank bottom and the tank walls, so that no coarse particles, which are sedimented in the tank, get absorbed and choke the sensor system.

## 2.4. Electrical connection

### 2.4.1. Mains operation

- The operating voltage of the CCS 4 amount to 15 V DC.
- To create the necessary operating voltage, connect the CCS 4 with the external power supply (100 V bis 240 V AC, 50/60 Hz). The power on the power supply is visible with a

green power indicator. **WARNING** 

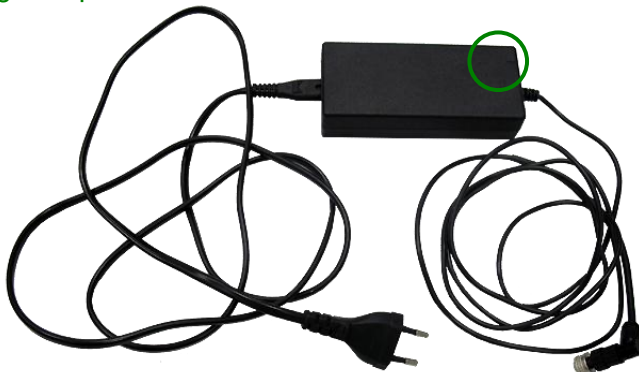

- For fuse protection use the T 5A – covering.

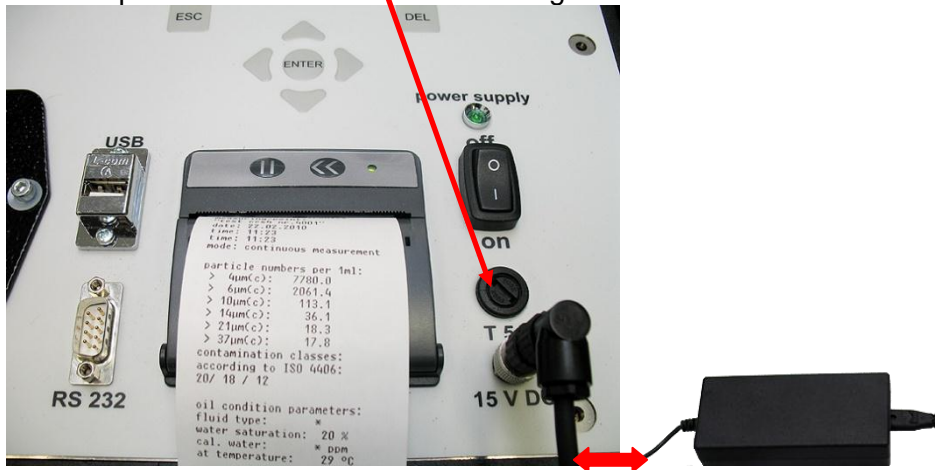

- Switch on the CCS 4 with the „power supply“ – switch to **ON**. (visible by the green control diode)



## 2.4.2. Battery operation

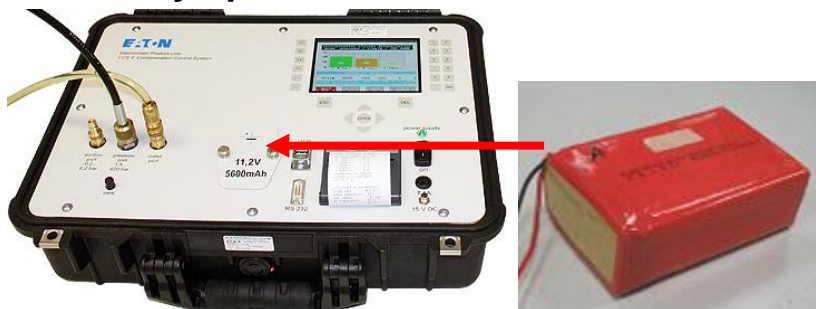

- The rechargeable lithium-polymer battery with internal battery charger is integrated in the CCS 4.
- It allows for an approximate continuous operating time of 3 hours without printing.
  - **NOTICE** Printing during battery operation shortens the running time extremely.
- **NOTICE** The CCS 4 switches off automatically when the internal battery is completely discharged. Then it is only possible to start the CCS 4 with the external power supply unit.
- The recharge time of the rechargeable battery is 5 hours and 15 minutes. For this recharge time it is necessary that the CCS 4 is switched to the main menu.
- Leave the main menu with [ESC] and the **charge state of the rechargeable battery** is displayed.

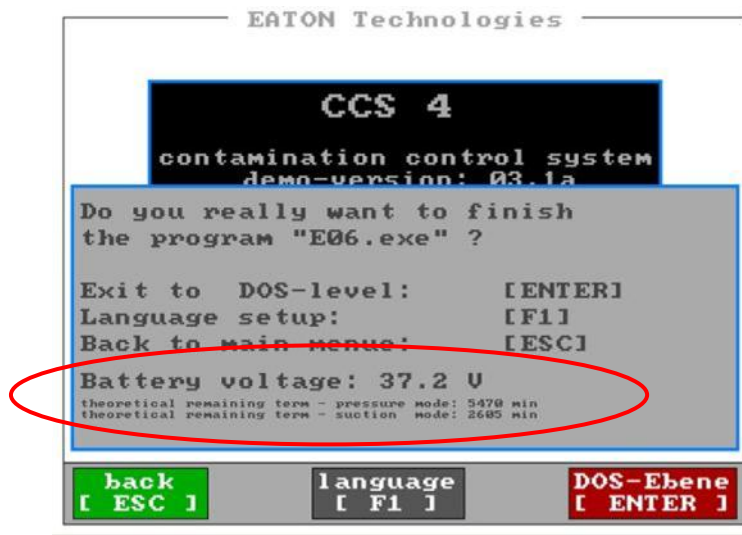

### Car supply

With a special cable it is possible to connect the CCS 4 with a 12 V car plug. (Thereby a charging of the internal battery does not take place!)

## 2.5. Usage of the CCS 4 software

- After connecting the necessary hoses, power and switching on the CCS 4, the unit is ready for operation. (green control diode lights)
- **At the start of the CCS 4 in the suction mode, press additional for some minutes the [VENT] – key.**



- After the starting routine the main menu appears on the display, which can be operated by using the key pad.
- The CCS 4 is, customer specific, equipped with the English or German menu display.
- An implementation of the measurement in the other language is possible at any time by finishing the current program and starting the desired program.

### 2.5.1. Changing the operator language

- Change the current operator language by finishing the program at the main menu.
- Leave the main menu with the [ESC] – key and switch to the language setup with [F1].

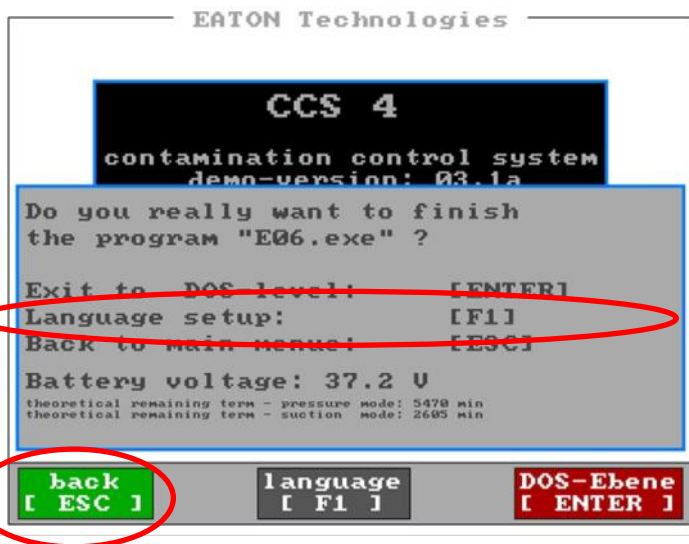

- Select the language by using the [←→] keys and confirm with [ENTER].

## 2.5.2. Changing to the demo mode

- Change the current software by finishing the program at the main menu.
- Leaving the main menu by using the [ESC] – key and changing to the DOS – mode with [ENTER].

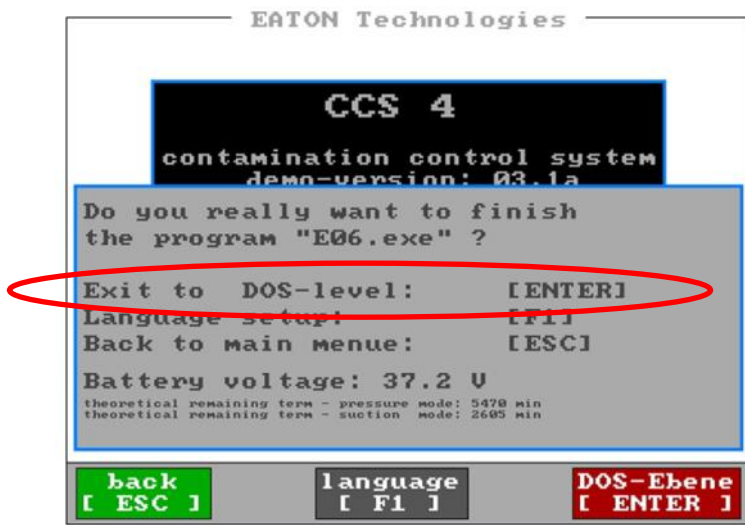

- The switch to the DOS-mode is indicated on top left now.

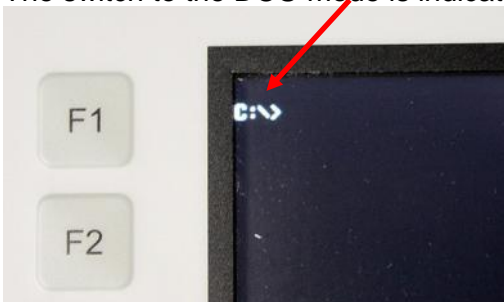

- Enter the desired program by using the key pad.

- Following programs are available:
 

<b>E16.exe</b>	English real version
<b>E06.exe</b>	English demo version
<b>D16.exe</b>	German real version
<b>D06.exe</b>	German demo version

**NOTICE** The demo version is operating in the same way as the real version. Instead of real measurements the computer simulates the counting and the results. You can use all functions as if in real version. The electro-hydraulic functions are disabled in the demo version operating mode!

### 2.5.3. Key pad

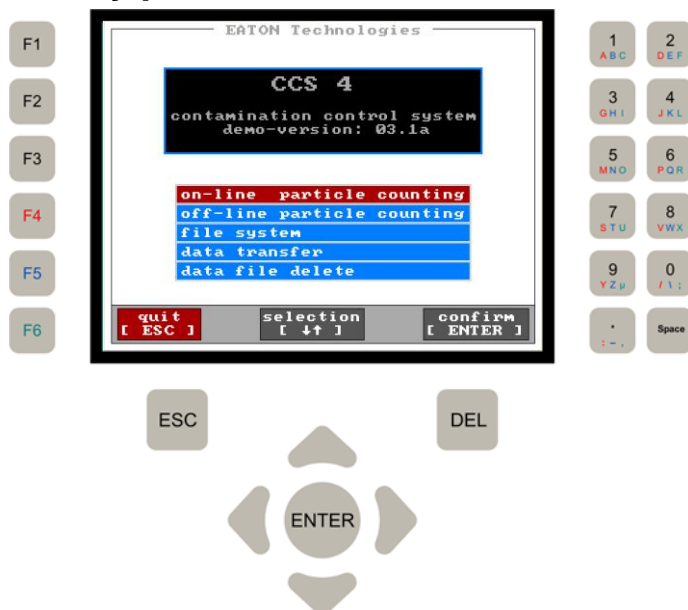

#### Keys for device and menu control:

- |                   |                           |
|-------------------|---------------------------|
| <b>Arrow keys</b> | for menu control          |
| <b>ESC</b>        | one step back in the menu |
| <b>ENTER</b>      | confirm enter             |
| <b>F1 – F6</b>    | function keys             |

#### Keys for the description of the measuring point:

- Numbers
- Letters
- F3/ F4/ F5/ F6

#### Explanation of functions – entering numbers and letters

- Double key configuration, i.e. numbers and letters are arranged on the same keys.
- By pressing the “number/letter“ key, only the according number is used.
- For using letters it is necessary to press the function keys additionally, i.e.
  - First press and hold [F4] (red), [F5] (blue) or [F6] (green) plus the number key according to the letter which is intended to be used.

**Example:**

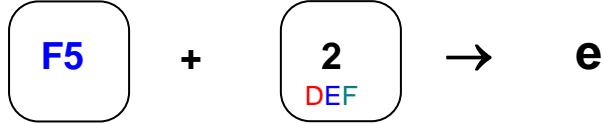
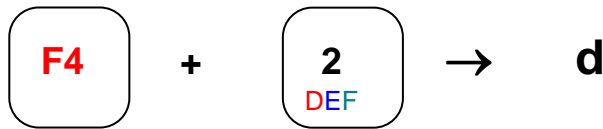

**Capital letters:**

Usually everything is written in lower case. For capital letters the key [F3] has to be additionally used.

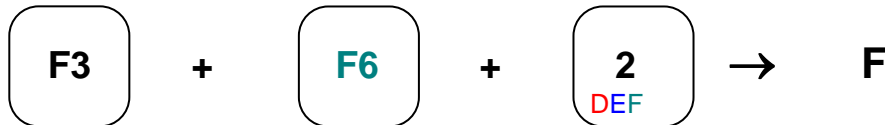

**2.5.4. Main menu**

- Start of the CCS 4 wait for the starting routine and for the main menu to be indicated at the display.
- The main menu enables the selection of the operating functions which the CCS 4 offers.

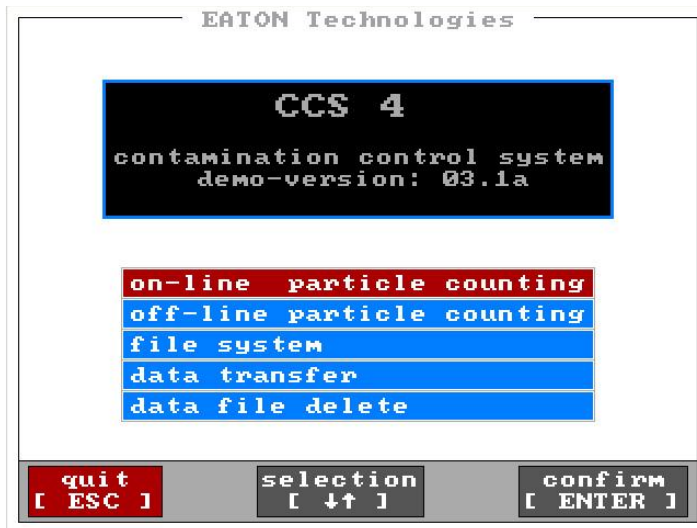

**Function selection:**

Select the desired function with the [↓↑] – keys. The selected function is highlighted red. Confirm the selection with [ENTER].

**On-line particle counting**

Accomplish of the measurements in pressure – or suction mode after the selection of the various measuring programs (single, continuous, cyclic), kind of report format (contamination classes) and if necessary the fluid type. The CCS 4 has to be connected to the statements under item 2.3).

### Off-line particle counting

Accomplish of the measuring of bottle samples in combination with the Bottle Sampling System (BSS 2). (see chapter 2.5.4.2) Refer to the instruction manual of the BSS 2. This mode is additionally usable for performing On-line single measurements.

### Data transfer

For transferring the saved and measured data files using the RS232 – interface. Output of the stored data to the USB – stick.

### Data file delete

In this mode it is possible to delete complete files of saved measuring results in the file system and to set time and date.

## 2.5.4.1. On-line particle counting

- For the On-line measuring in the appropriate operating mode (depending upon the hydraulic connection, see chapter 2.3).
- The following parameters are entered in the setup menu “**contamination classes determination**“:
  - Name of the measuring point
  - Selection of the measure-type
  - Selection of the report format (ISO 4406:99, NAS 1638, SAE AS 4059)
  - Selection of the operation mode (pressure mode or suction mode)
  - Selection of the test fluid

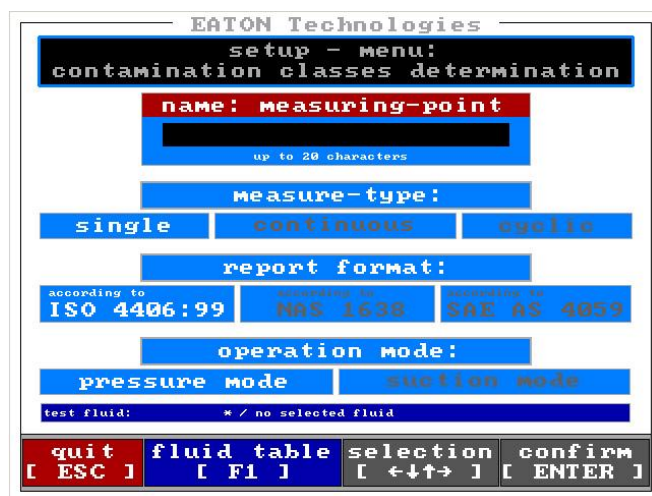

- Select the desired function with the [↓↑] – keys.  
⇒ The selected function is highlighted red.
- Selection of the parameter with the [← →] – keys (highlighted white) and confirm the selection with [ENTER].
- [F1] Display of the fluid selection index.
- [ESC] back to the main menu.

### Measuring point:

After opening the mode “**On-line particle counting**“, this function is automatically selected and highlighted red. Enter the name of your measuring point by using the key pad. (See chapter 2.5.3) In case of typing errors press the [DEL] – key. The maximum capacity is 20 characters.

Always use the same name for the same measuring point, so that the stored data can be systematized within the data file system. Every measurement automatically gets a new index in the data file system, also the current date and time of the current measurement is stored. Measurements are displayed depending on the data sorting.

If no identification is entered, “**noname**” is automatically used.



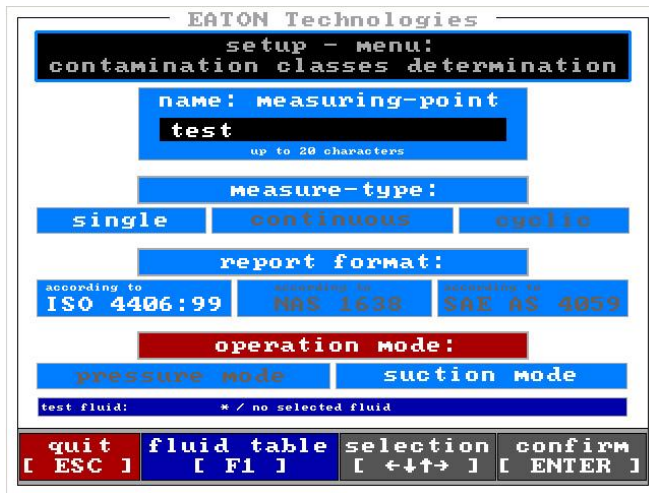

By using the [↓↑] – keys switch to the next selection mode.  
 ⇒ The selected mode is highlighted red.

Measure-type:

Select the measure-type (single, continuous, cyclic) by using the [← →] – keys. The selected measure-type appears white.

Report format:

It is possible to display the measurements according to ISO 4406:99 or NAS 1638 or SAE AS 4059. Select the classification format with the [← →]- keys. (The selection appears white.)

Operating mode:

Select the operating mode (suction or pressure mode) using the [← →] - keys. The selected operating mode appears white. **NOTICE** When starting the measurements in suction mode, than press additional the [VENT] – key at the beginning of the measurements in the next measuring menu.

Test fluid:

For the additional display of the existing theoretical ppm water content during the measurements, the type of oil to be measured must be selected. If no test fluid is selected then the measurements will only display the water saturation in % and not the corresponding PPM. The selection of the system fluid from the fluid index is performed by using the [F1] – key.

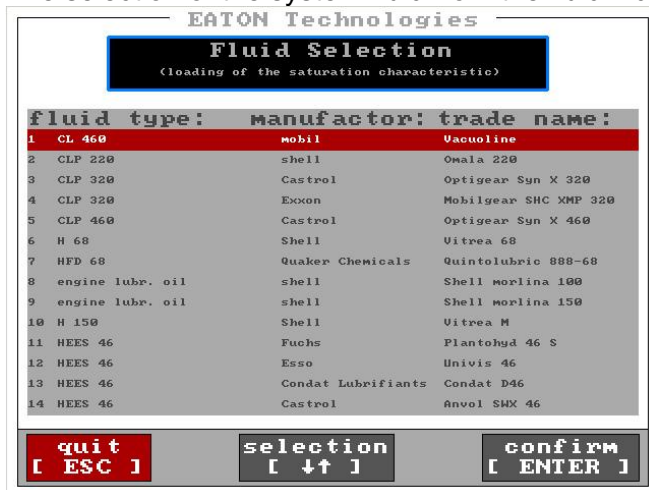

Select the fluid using the [↓↑] – keys (selection is highlighted red) and confirm with [ENTER].

- ⇒ After selecting a fluid the screen will automatically change to the previous menu.
- ⇒ The selected fluid is indicated in the display.

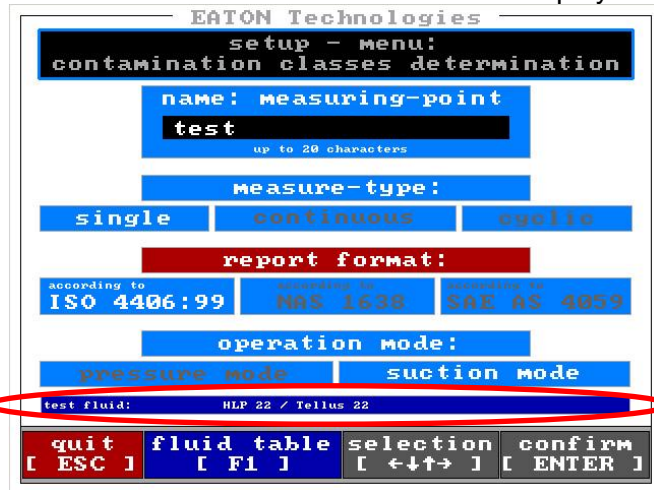

After entering all the necessary measurement parameters, confirm with [ENTER] and this will take you to the next menu.

### 2.5.4.1.1. Measure-type: On-line single

- This mode is to accomplish a single measurement.
- Three measurements are done one after another; the average value of the three measurements is shown on the display.
- The procedure as described in detail below is performed in any selected operation mode (suction or pressure operation) and classification type (ISO 4406:99, NAS 1638, SAE AS 4059). (Example: “suction mode” and “ISO 4406:99”).

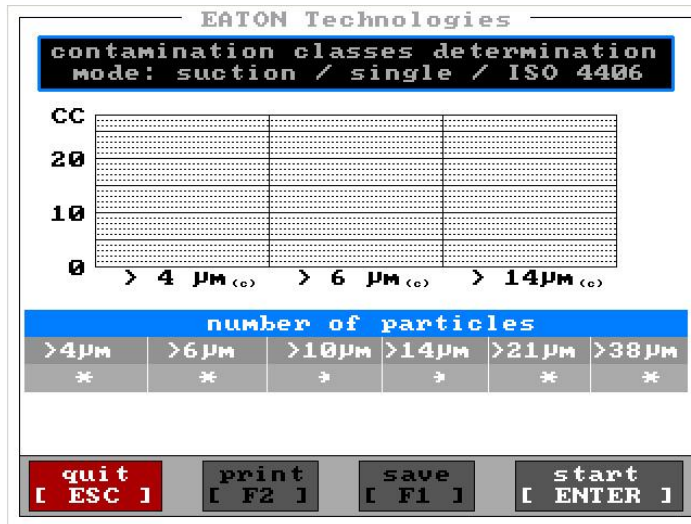

- Start the measurements with [ENTER].

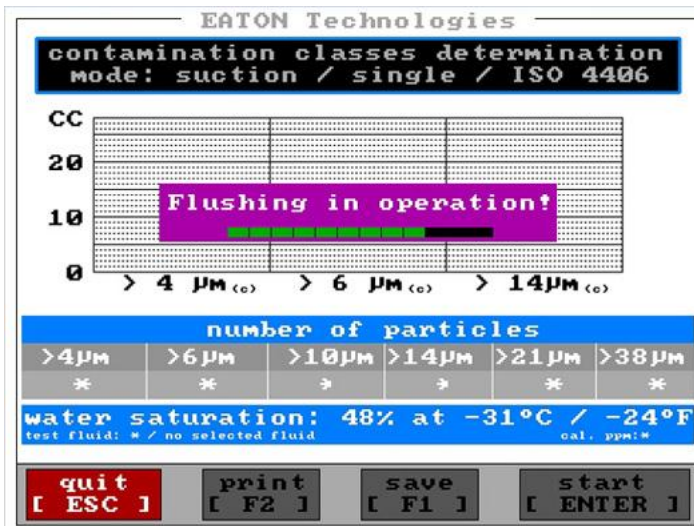

- An automatic flushing starts before the first measurement is displayed.
- The first measurement starts after 12 flushing cycles.

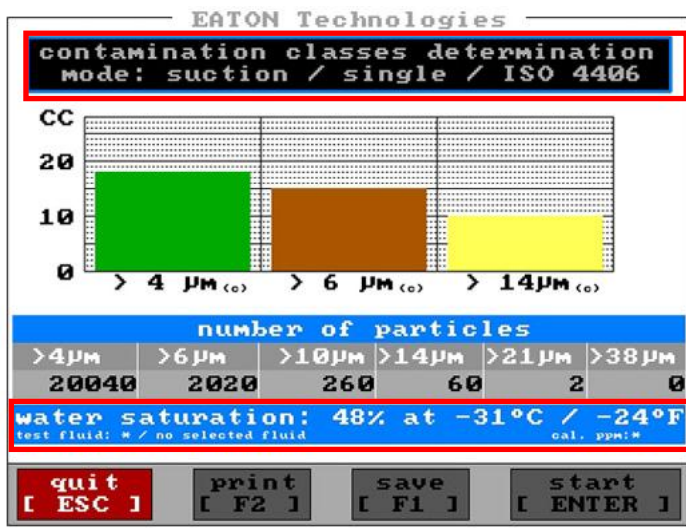

- The operating mode selected in the preceding menu, the classification type and the measuring mode are shown in the headline.
- Both the water saturation and the temperature are shown with each measurement. When a fluid type is selected then the ppm water content is also displayed.

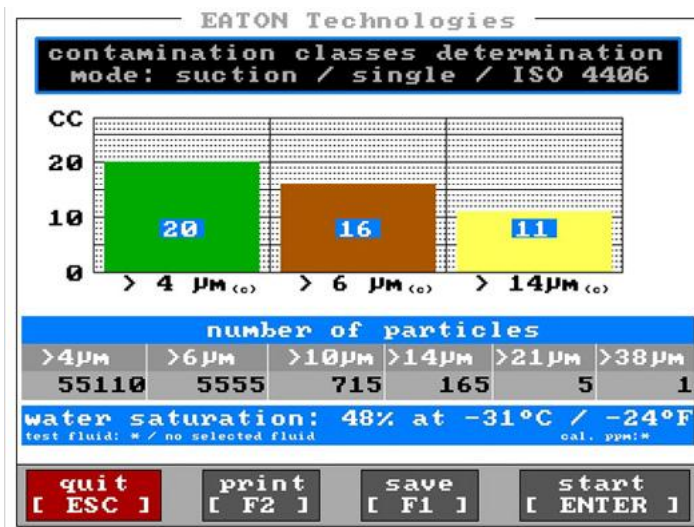

- Three measurements are done one after another; the average value of the three measurements is shown on the display
- After the average of the three measurements is displayed, they can be printed by using [F2] and/ or saved by using [F1].

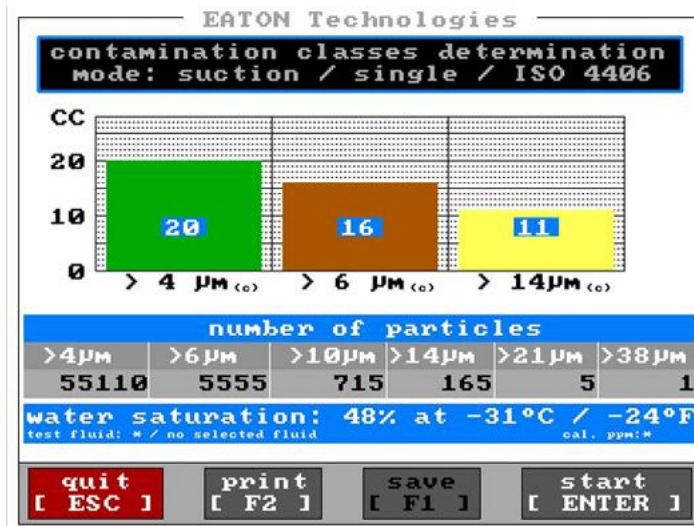

**NOTICE** The average of the measurements will not be automatically saved. It is only possible to save with [F1]!

- New start with [ENTER].
- With [ESC] back to the previous menu „Setup: contamination classes determination“.

**NOTICE**

To assure constant mode of operation of the unit and the accuracy of measurement results, it is recommended to perform a flushing of the CCS 4 with cleaned mineral oil (filtrated H22) for several minutes after finishing the measurements.

### 2.5.4.1.2. Measure-type: On-line continuous

- This mode is to accomplish the continuous measurements.
- After the second measurement a trend of the results will be shown on the display.
- **NOTICE** While measuring it is not possible to print.
- The following details describe the operational sequence that takes place in each selected operating mode (pressure or suction mode) and the kind of classification (ISO 4406:99, NAS 1638, SAE AS 4059). (Example: „Suction mode “and „ISO 4406:99 “)

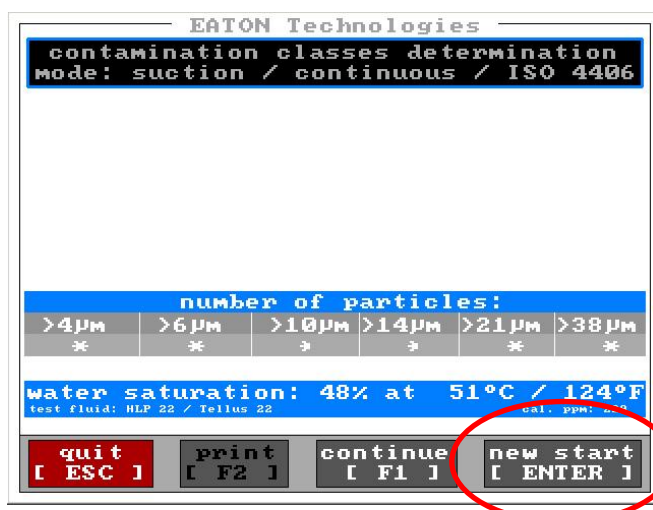

- New start with [ENTER].  
⇒ All existing saved measurements were deleted in the file continuous register before it will start a new continuous measurement.

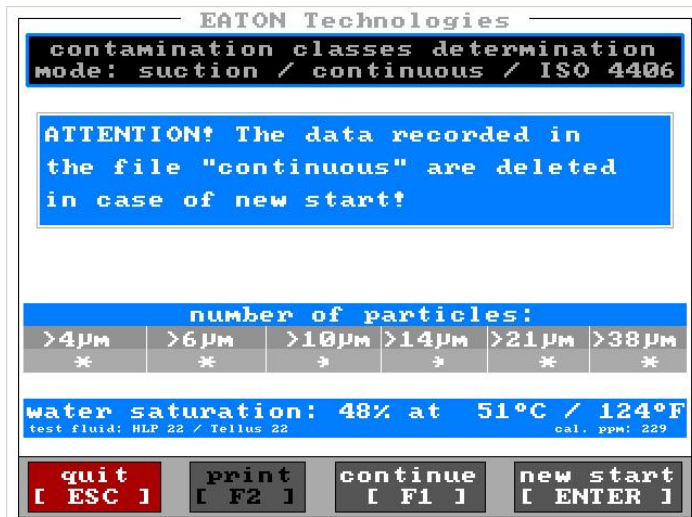

- Start with [F1] will create a continuation of the measurements in the file system.  
⇒ New measurements are saved after the existing data files in the data system.

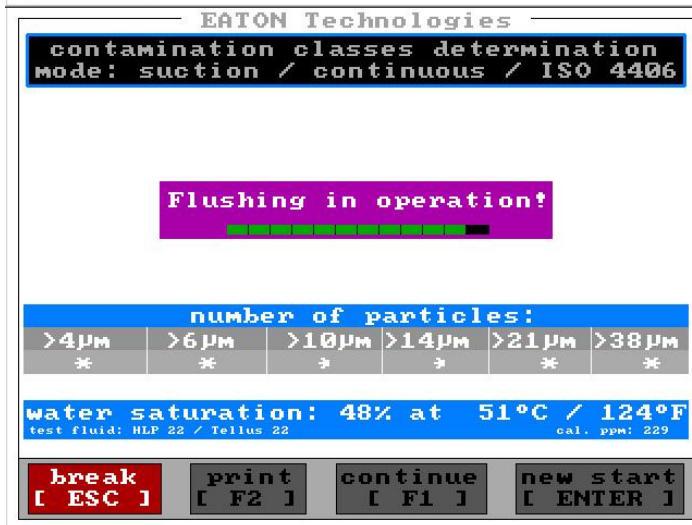

- An automatic flushing starts before the first measurement is displayed.
- The first measurement starts after 12 flushing cycles.

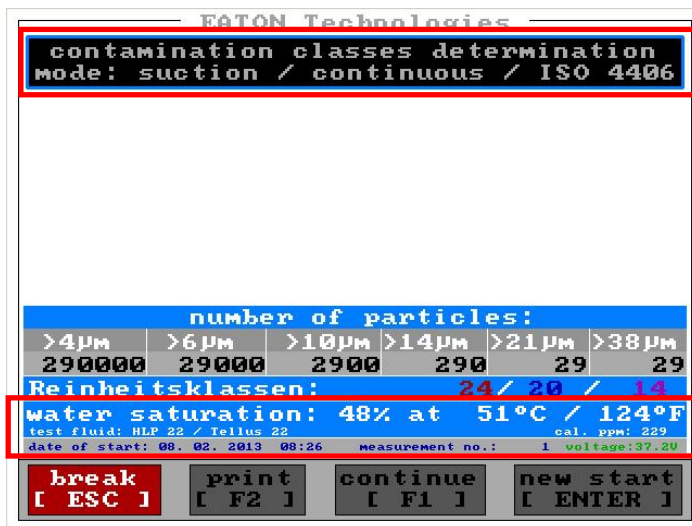

- The operating mode selected in the preceding menu, the classification type, and the measuring mode are shown in the headline.
- Both the water saturation and the temperature are shown with each measurement. When a fluid type is also selected, then the ppm water content is also displayed.

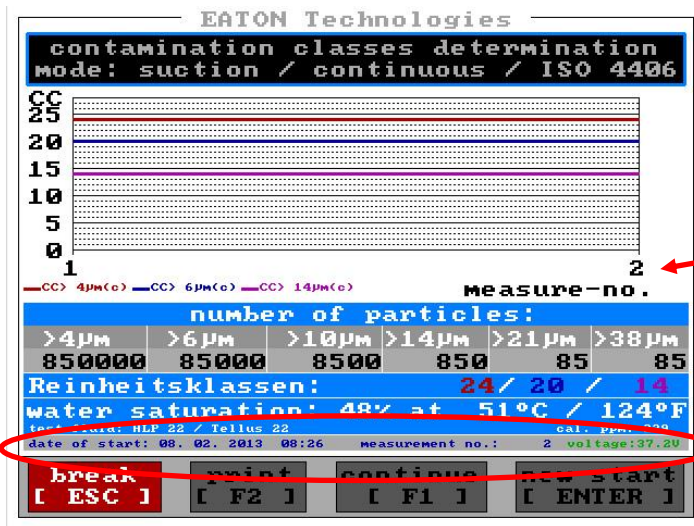

- The numbers of each measurement and the date of start is displayed.

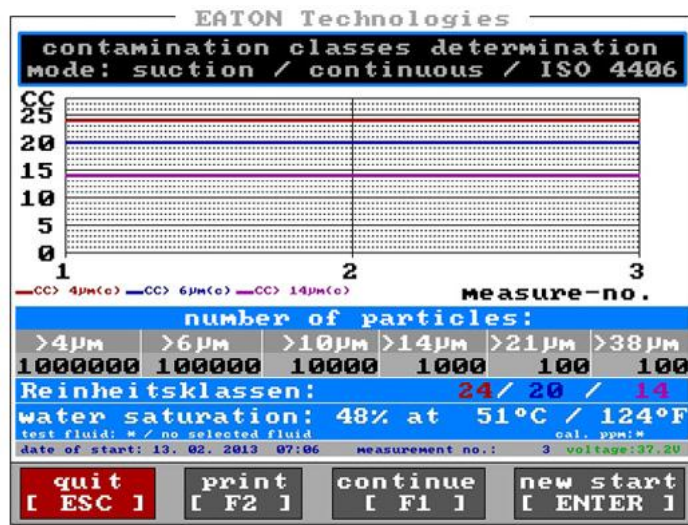

- The measurements are continued until they get stopped with [ESC].
- The interruption takes place after the end of the current measurement.  
⇒ Visible by the change from black to highlighted white of the function display.

- Once the unit has finish last measurement and the function keys are highlighted white, then the user can chose to print the results by using the [F2] key.
- The **continuation of the measurements** takes place with [F1]. The new measurements are added to the existing data at the data storage. (see chapter 2.5.4.3)
- With [ENTER] a **new start** is made. The **data storage of the measuring type „continuous“ is completely deleted and afterwards new measurements are written!!** (see chapter 2.5.4.3)
- With the [ESC] key back to the previous menu „Setup: contamination classes determination“.
- Furthermore the measurements are continuously shown by the RS232 – interface during the measurement procedure and can be displayed and read by a communication software like MS HyperTerminal or the provided Data Manager Software (under Terminal) (see chapter 0)

#### NOTICE

To assure constant mode of operation of the unit and the accuracy of measurement results it is recommendable to perform a flushing of the CCS 4 with cleaned mineral oil (filtrated H22) for some minutes after finishing the measurements.

### 2.5.4.1.3. Measure-type: On-line cyclic

- This mode is to accomplish the cyclic measurements.
- The procedure as described in detail below is performed in any selected operation mode (suction or pressure operation) and classification type (ISO 4406:99, NAS 1638, SAE AS 4059). (Example: “suction mode” and “ISO 4406”).

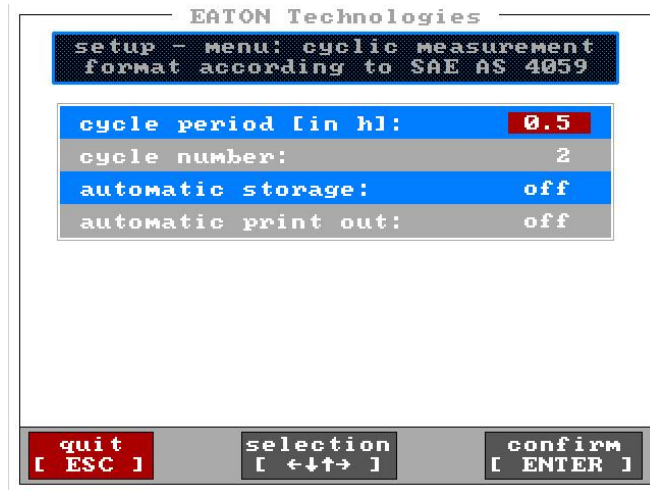

- Selection of the parameter for the cyclic measuring.
- Select the desired position with then [↑↓] - keys. (The selected position is highlighted red.)
- Change the value of the red highlighted position by using the [← →] – keys. The possible values are predetermined.

#### Cycle periode in h

The time between one measurement and the next one can be selected between 0,5 hours to 24 hours in half hour steps.

#### Cycle number

The total number of measurements can be chosen two-steps wise from 2 to 100.

#### Automatic storage

Optionally every cyclic measurement can be saved automatically by setting the automatic storage to “ON”.

#### Automatic print out

When chosen automatic print out: “ON”, then every average value is saved after the measuring cycle.

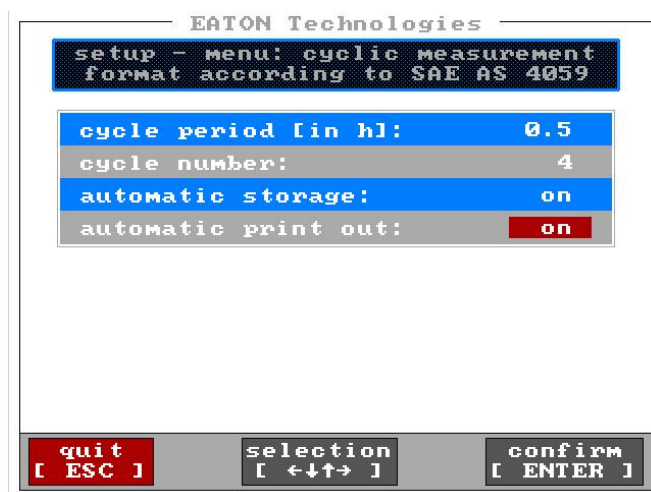

- Confirm the parameter selection with [ ENTER ].

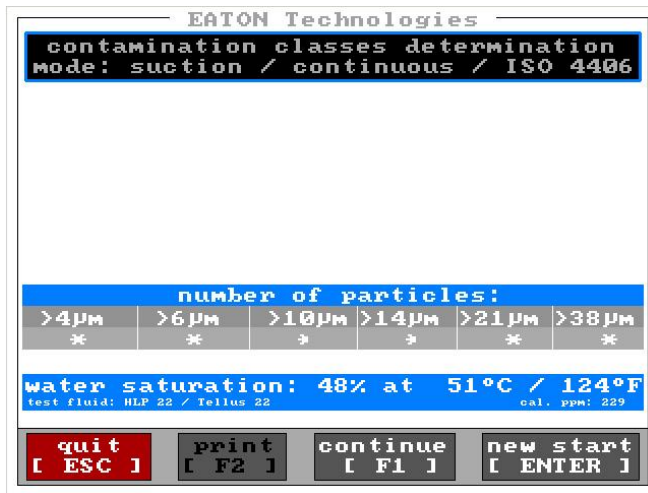

- Start the cyclic measurement with [ ENTER ].

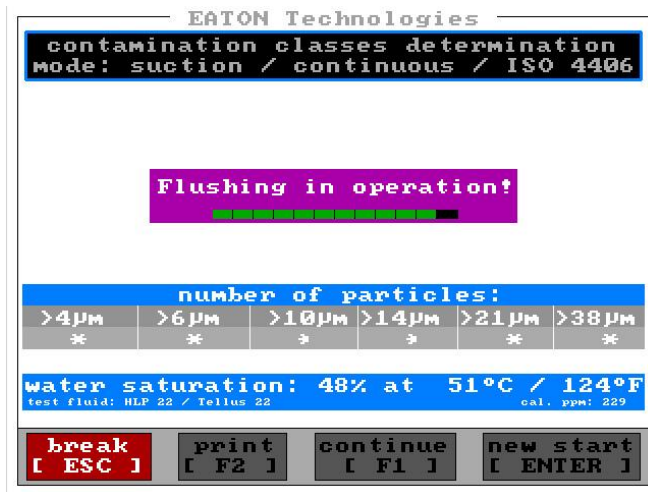

- An automatic flushing starts before the first measurement is displayed.
- The first measurement starts after 12 flushing cycles.

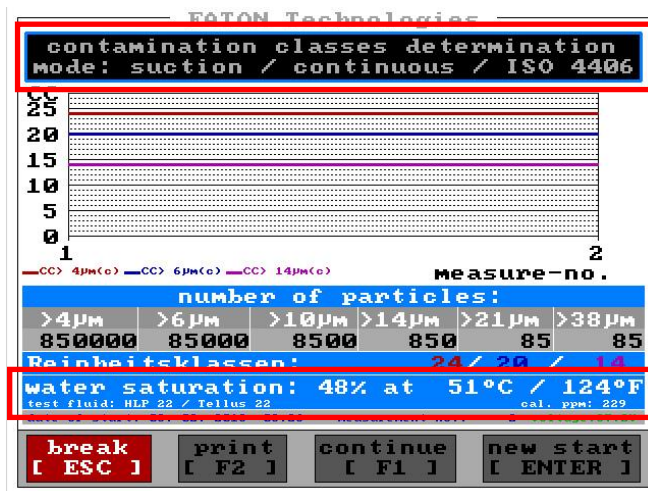

- The operating mode selected in the preceding menu, the classification type and the measuring mode are shown in the headline.
- Both the water saturation and the temperature are shown with each measurement. When a fluid type is also selected, then the ppm water content is also displayed.



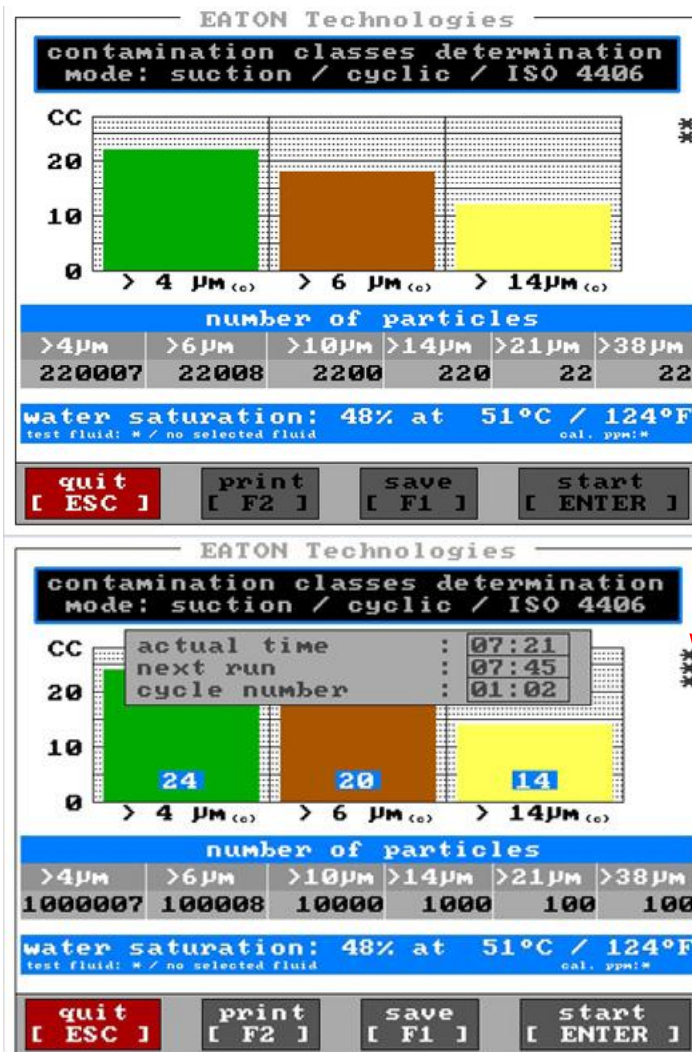

- Three measurements are done.
- The number of measurements is displayed by the respective number of stars.
- The last indicated result complies with the average value of the three previous measurements.
- Between two cycles a notice shows the actual time, the time of the next run and the number of done cycles.
- When all cyclic measurements are done, there is a headline on the notice that says "measurement finished".
- New measurement start with [ENTER] or
- back to the previous menu „Setup: contamination classes determination“ with [ESC].

- With the [ESC] key it will take you back to the previous menu „Setup: contamination classes determination“.

#### NOTICE

To assure constant mode of operation of the unit and the accuracy of measurement results it is recommendable to perform a flushing of the CCS4 with cleaned mineral oil (filtrated H22) for some minutes after finishing the measurements.

### 2.5.4.2. Off-line Particle Counting

- For the Off-line measuring in the appropriate operating mode (depending upon the hydraulic connection, see chapter 2.3)
  - Measuring of bottle samples in combination with the Bottle Sampling System BSS 2.
  - Accomplishment of single measurements.

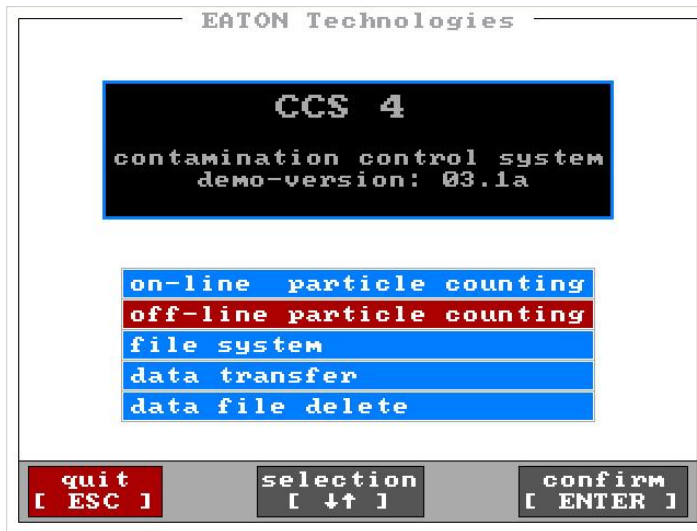

- Select the desired function with the [↓↑] – keys. (highlighted red)
- Confirm the selection with [ENTER]

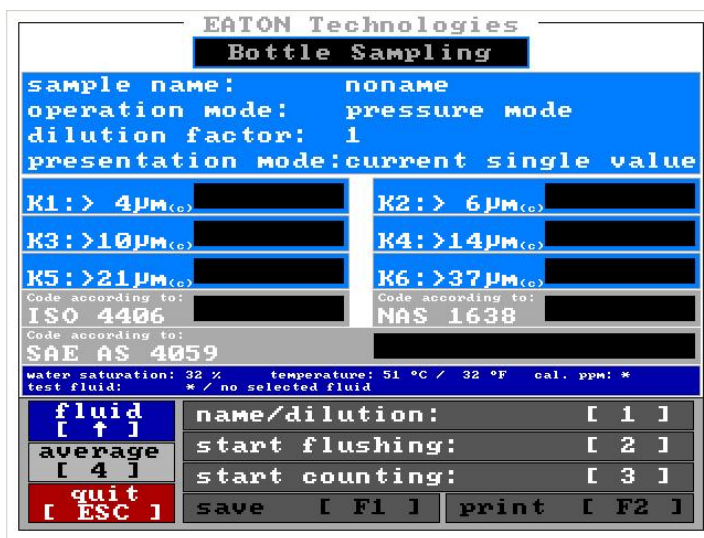

- After the measurement are displayed:
  - the determined contamination classes according to ISO 4406:99, NAS 1638 and SAE AS 4059,
  - the temperature,
  - the water saturation.
- If the fluid type is chosen, the water content in ppm is additionally displayed.

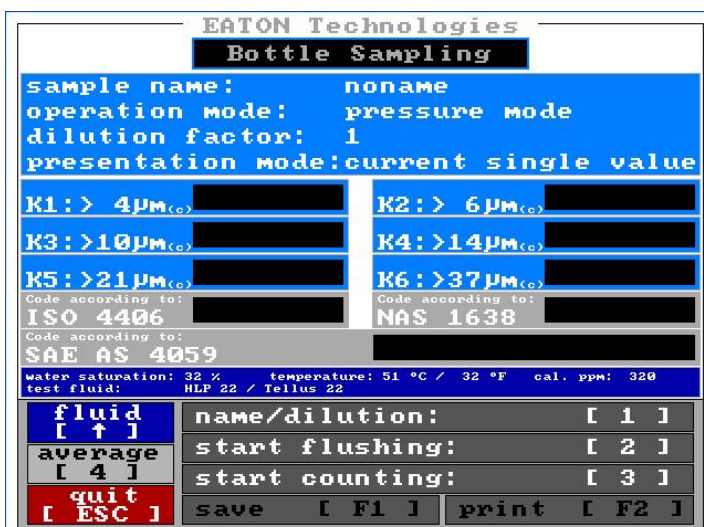

- Select the fluid type with [↑].

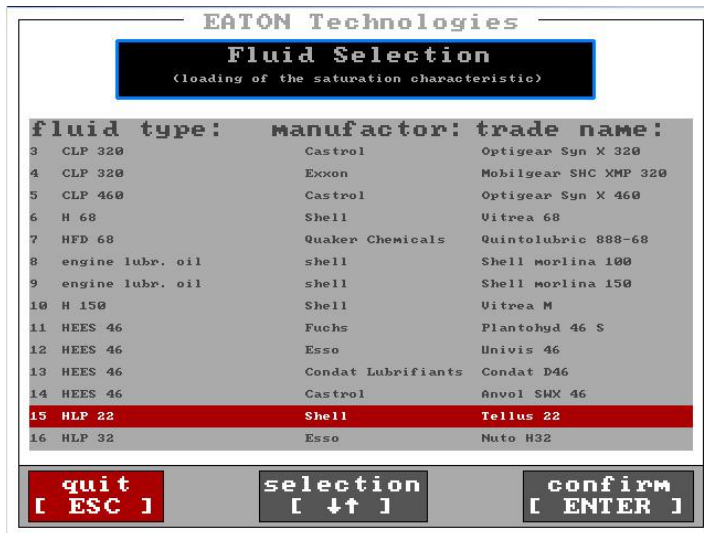

- Select the fluid using the [↑↓] – keys (selection is highlighted red) and confirm with [ENTER].

⇒ Automatically changes to the previous menu.

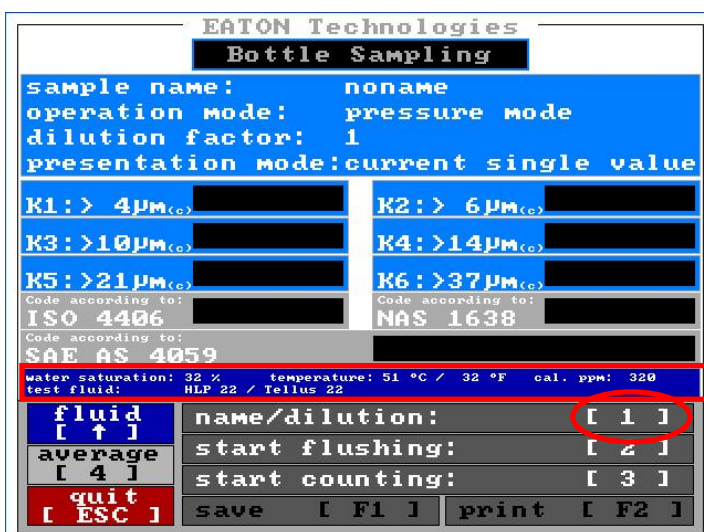

- The selected fluid is being indicated at the display.

- Change to the menu „name/dilution“ with [ 1 ] key.

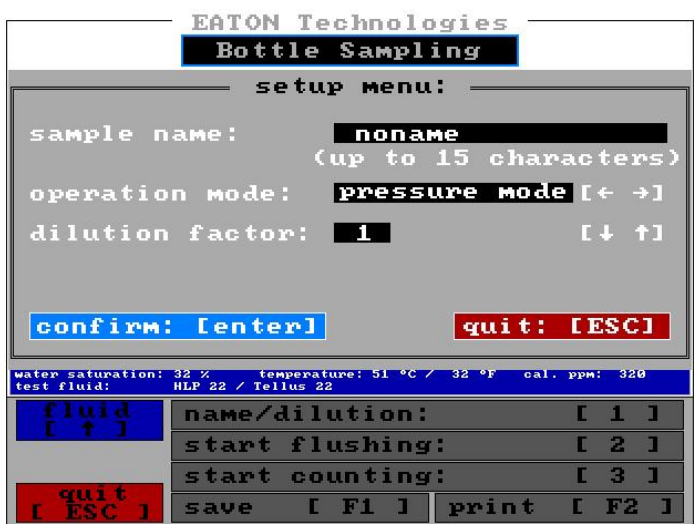

- Enter the sample name, the dilution factor and the operating mode by using the [← →] and the [↓↑].

#### Sample name:

- If no identification is entered, “noname” is automatically used.
- Delete the existing identification name with [DEL] and enter the new sample name by using the key pad. (see chapter 2.5.2)
- The maximum capacity is 15 characters.

**NOTICE** Always use the same sample name for the same measuring point, so that the stored data can be systematized within the data file system. Every event automatically gets a new index in the data file system, also the current date and time of the current measurement is stored. Measurements are displayed depending on the date.

Operation mode:

- Depending on the hydraulic connection, select the operation mode (pressure mode or suction mode) with the [ → ← ] – keys.

Dilution factor:

- The factor 1 is used automatically. This means, that the original sample is measured without a dilution.
- For measuring diluted oil samples changing of the factor stepwise with the [ ↑↓ ] – keys.

dilution	dilution factor	Mixing proportion	
		Volume oil sample	Volume filtrated mineral oil H22
-----	1	200 ml	-----
1 : 1	2	100 ml	100 ml
1 : 2	3	70 ml	140 ml
1 : 3	4	50 ml	150 ml
1 : 4	5	40 ml	160 ml
1 : 5	6	30 ml	150 ml
1 : 9	10	20 ml	180 ml



- Deletion of the inputs by using [ ESC ].
- Confirmation of the changed inputs by using [ ENTER ].  
⇒ Automatically changes to the previous menu.

```

EATON Technologies
  Bottle Sampling
sample name:      noname
operation mode:   pressure mode
dilution factor: 1
presentation mode:current single value
K1:> 4µm(ce)
K2:> 6µm(ce)
K3:>10µm(ce)
K4:>14µm(ce)
K5:>21µm(ce)
K6:>37µm(ce)
Code according to:
ISO 4406
Code according to:
SAE AS 4059
water saturation: 32 %      temperature: 51 °C / 32 °F      cal. ppm: *
test fluid:          * / no selected fluid
fluid [ ↑ ]      name/dilution:      [ 1 ]
average [ 4 ]    start flushing:      [ 2 ]
quit [ ESC ]     start counting:      [ 3 ]
save [ F1 ]     print [ F2 ]

```

- Start to flush with [ 2 ].
- Make approximately 3 – 4 flushing cycles.

```

EATON Technologies
  Bottle Sampling
sample name:      testt
operation mode:   suction mode
dilution factor: 5
presentation mode:current single value
System flushing in operation!
number of flushing cycles: 3
ISO 4406
NAS 1638
Code according to:
SAE AS 4059
water saturation: 32 %      temperature: 51 °C / 32 °F      cal. ppm: 320
test fluid:          HLP 22 / Tellus 22
fluid [ ↑ ]      name/dilution:      [ 1 ]
average [ 4 ]    stop flushing:      [ 5 ]
quit [ ESC ]     start counting:      [ 3 ]
save [ F1 ]     print [ F2 ]

```

- At the beginning of the flushing the number of finished flushing cycles are displayed.
- Stop the flushing with [ 5 ].

```

EATON Technologies
  Bottle Sampling
sample name:      noname
operation mode:   pressure mode
dilution factor: 1
presentation mode:current single value
K1:> 4µm(ce)
K2:> 6µm(ce)
K3:>10µm(ce)
K4:>14µm(ce)
K5:>21µm(ce)
K6:>37µm(ce)
Code according to:
ISO 4406
Code according to:
NAS 1638
Code according to:
SAE AS 4059
water saturation: 32 %      temperature: 51 °C / 32 °F      cal. ppm: 320
test fluid:          HLP 22 / Tellus 22
fluid [ ↑ ]      name/dilution:      [ 1 ]
average [ 4 ]    start flushing:      [ 2 ]
quit [ ESC ]     start counting:      [ 3 ]
save [ F1 ]     print [ F2 ]

```

- Start counting with [ 3 ].
- One measurement is accomplished.

```

EATON Technologies
  Bottle Sampling

sample name:      testt
operation mode:   suction mode
dilution factor: 5
presentation mode:current single value

K1:> 4µm(co) 1000300  K2:> 6µm(co) 100100
K3:>10µm(co) 10400    K4:>14µm(co) 1100
K5:>21µm(co) 10      K6:>37µm(co) 1
Code according to: ISO 4406 26/23/16  Code according to: NAS 1638 15/11/ 6
Code according to: SAE AS 4059 13/13/10/ 6/ 5/ -
water saturation: 32 %  temperature: 51 °C / 32 °F  cal. ppm: 320
test fluid:      HLP 22 / Tellus 22

fluid [ ↑ ]  name/dilution: [ 1 ]
average [ 4 ]  start flushing: [ 2 ]
quit [ ESC ]  start counting: [ 3 ]
save [ F1 ]  print [ F2 ]

```

- After the completion, the measurement can be saved by using [ F1 ], print by using [ F2 ],

or

averaged by using [ 4 ].  
(Select the measurement for the averaging)

```

EATON Technologies
  Bottle Sampling

sample name:      testt
operation mode:   suction mode
dilution factor: 5
presentation mode:current single value

K1:> 4µm(co) 1000300  K2:> 6µm(co) 100100
K3:>10µm(co) 10400    K4:>14µm(co) 1100
K5:>21µm(co) 10      K6:>37µm(co) 1
Code according to: ISO 4406 26/23/16  Code according to: NAS 1638 15/11/ 6
Code according to: SAE AS 4059 13/13/10/ 6/ 5/ -
water saturation: 32 %  temperature: 51 °C / 32 °F  cal. ppm: 320
test fluid:      HLP 22 / Tellus 22

fluid [ ↑ ]  name/dilution: [ 1 ]
start flushing: [ 2 ]
start counting: [ 3 ]
save [ F1 ]  print [ F2 ]
quit [ ESC ]

```

**NOTICE** If the measurement is saved with [F1], this measurement can't be use for the averaging.

```

EATON Technologies
  Bottle Sampling

sample name:      test
operation mode:   suction mode
dilution factor: 1
presentation mode:current average [1]

K1:> 4µm(co) 1000300  K2:> 6µm(co) 100100
K3:>10µm(co) 10400    K4:>14µm(co) 1100
K5:>21µm(co) 10      K6:>37µm(co) 1
Code according to: ISO 4406 24/21/14  Code according to: NAS 1638 14/ 8/ 4
Code according to: SAE AS 4059 13/12/ 8/ 4/ 3/ -
water saturation: 32 %  temperature: 51 °C / 32 °F  cal. ppm: 320
test fluid:      HLP 22 / Tellus 22

fluid [ ↑ ]  name/dilution: [ 1 ]
average [ 4 ]  start flushing: [ 2 ]
quit [ ESC ]  start counting: [ 3 ]
save [ F1 ]  print [ F2 ]

```

- Select the measurement for the averaging with [ 4 ].

⇒ The current average and the actual average measurements are displayed.

- The displayed average can be print with [ F2 ], save with [ F1 ].

**NOTICE** The saved average results are marked with an "M" in the file system and the number of averaged measurements is showing by an index. (see chapter 2.5.4.3.1)

- Afterwards it is possible to measure once more by using [ 3 ] and select the measurement for the averaging by using [ 4 ].

**NOTICE** Pay attention

- to select similar measurement data to create the average value!
- that there is sufficient volume in the bottle before starting the measurement – avoid any air access!

- Back to the main menu with [ ESC ].

**NOTICE**

To assure constant mode of operation of the unit and the accuracy of measurement results it is recommendable to perform a flushing of the CCS 4 with cleaned mineral oil (filtrated H22) for some minutes after finishing the measurements.

### 2.5.4.3. File system

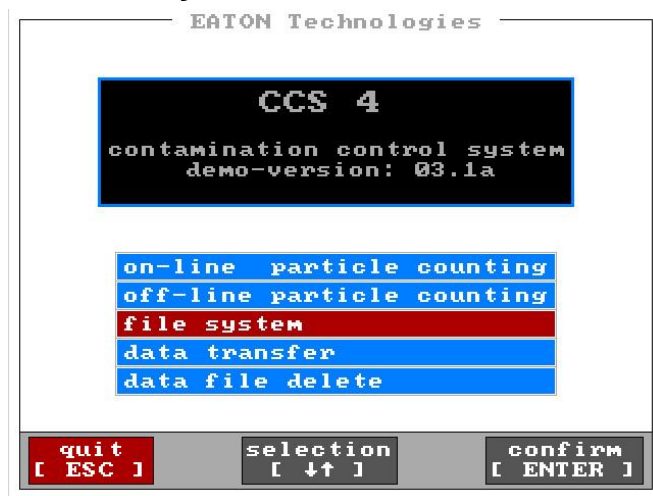

- Using this menu point the stored measurement data can be accessed, printed and deleted.

- The measurements in the permanent data storage persist until they are deleted manually or the maximum quantity of the storage data is exceeded.
  - **Max. 100** measurements of each measure-type can be **saved** in the data storage. Thereafter, at each subsequent measurement, the data that is on the first place in the data storage is being deleted and overwritten by new data.  
⇒ **First out - Last in.**
  - You may delete a single measurement with the [F1] key in the “File System”.
  - You may delete the complete data set from the measured data storage in the mode “data file delete” and this removal of data is irreversible (see chapter 0)!
- The stored measurements can be forwarded to an external computer using the RS232 – interface and administrated by the provided Data Manager software and transferred to MS EXCEL. (see chapter 2.5.4.4.1).
  - And / or transferred, as a TXT – file using the USB – interface to USB – stick (memory capacity:<2 GB, FAT:16) (see chapter 2.5.4.4.2)
- The procedure as described in detail on the next page is always the same with all measuring modes (single, continuous, cyclic, bottle sampling).

For illustration purposes the procedure is shown in one measuring mode only.

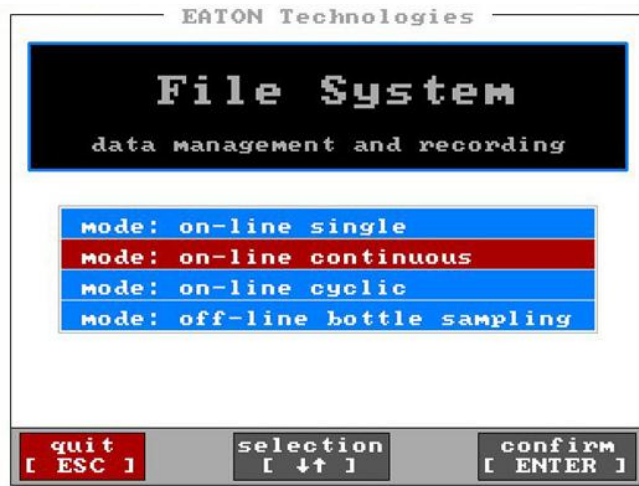

- Select the measuring type with their [↑↓] – keys and confirm with [ENTER].

⇒ The selected menu point is highlighted red.

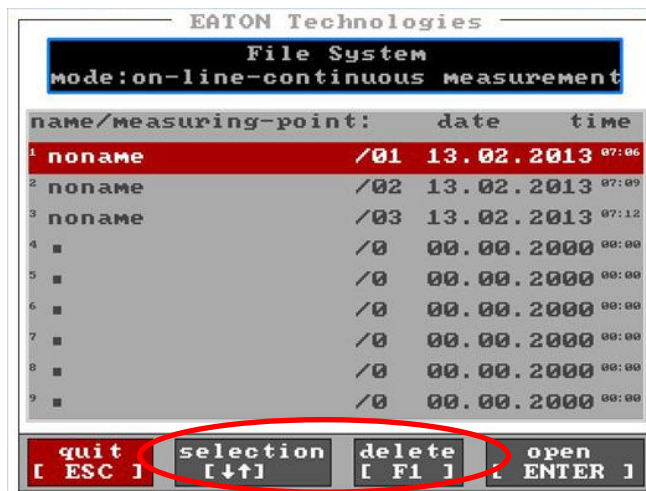

- The saved files will be indicated according date and time.

- The saved measurements can be selected with the [↑↓] – keys and/ or deleted from the data storage with [F1]. (Irreversible!)

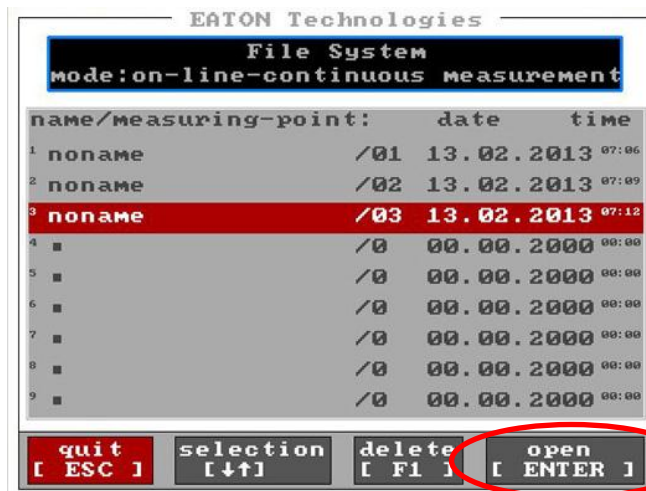

- Select the saved measurement with [↑↓] and open the data set with [ENTER].



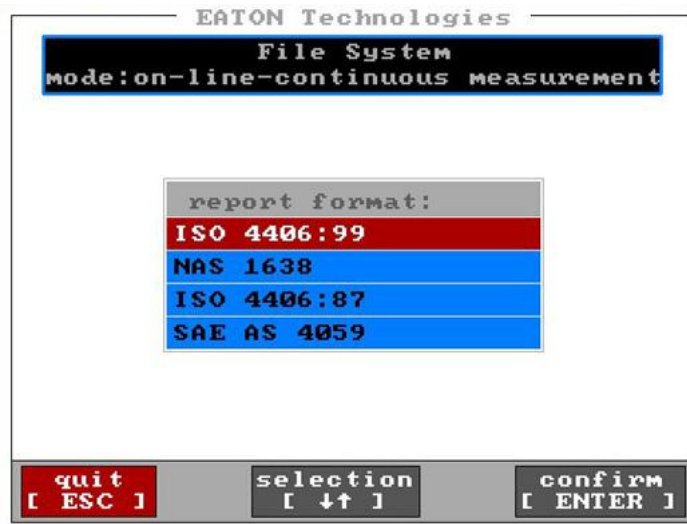

- Select the report format by using the [ ↑↓ ] – keys. (highlighted red)

⇒ the selected data displayed.

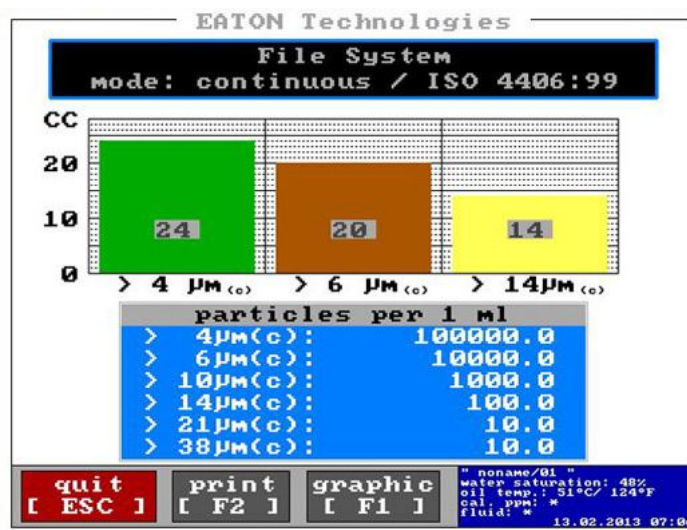

- Display of the measuring data, the sample name, the date/ time, the temperature and the water saturation.

The water content in ppm is additionally displayed when a fluid type is chosen.

```
" noname/05 "  
water saturation: 48%  
oil temp.: 51°C/ 124°F  
cal. ppm: 229  
fluid: HLP 22  
25.02.2010 15:49
```

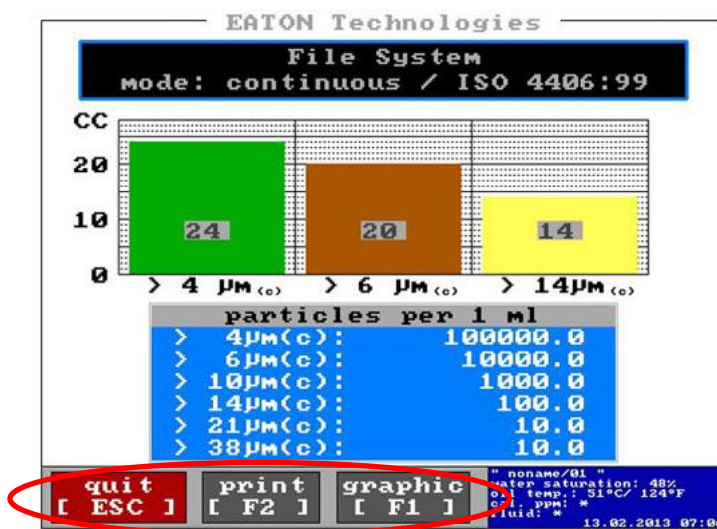

- Print the measurement file with [F2].

- Graphical presentation of the measurement results with [F1].

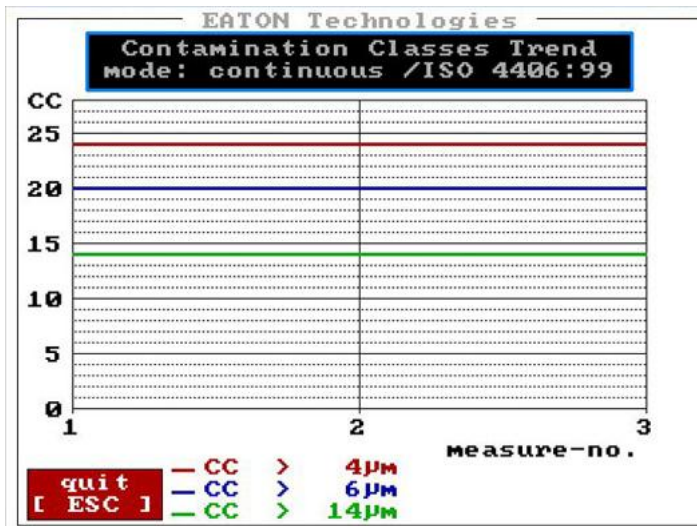

- Graphical presentation of the measurement results.
- Back to the previous menu with [ESC].

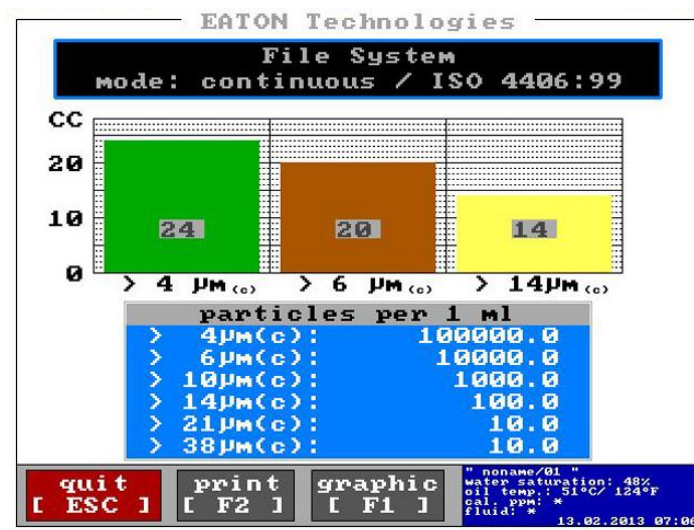

- Back to the previous menu with [ESC].

### 2.5.4.3.1. Display of the average (Off-line mode)

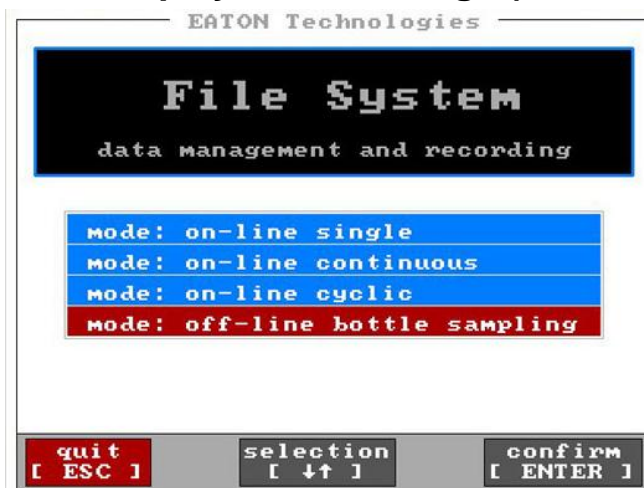

- Select the „off-line bottle sampling“ by using the [↑↓] – keys and confirm with [ENTER].

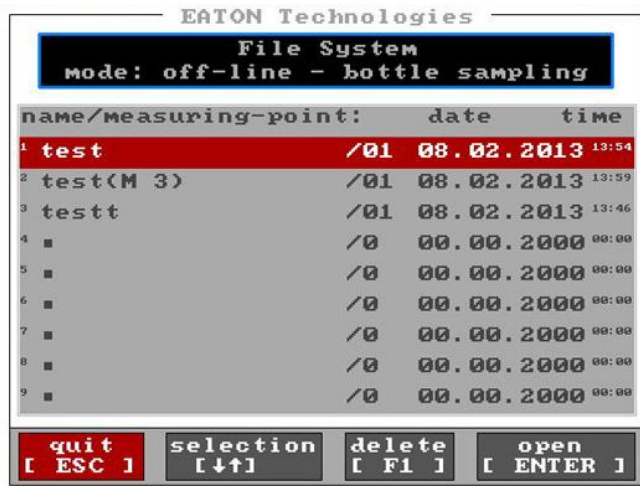

- The saved average value is displayed with “M” and the quantity of the measurements with “2”.
- As per this example the average value had been created and saved from 2 measurements.
- The selection of the saved average confirm with [ENTER].

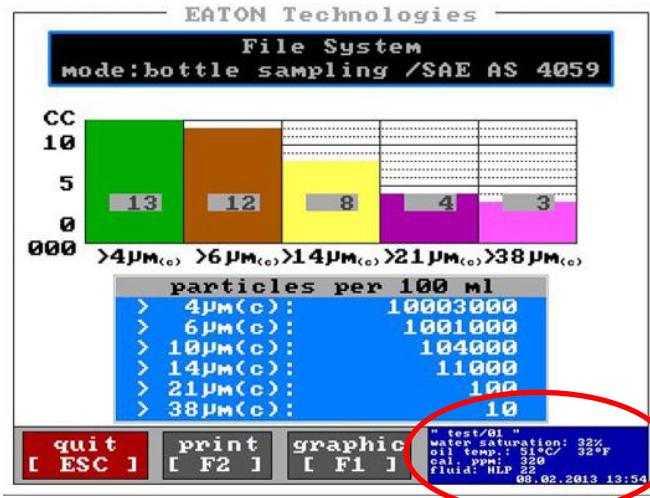

- The average of both measurements will be displayed through the selected classification.

- With the [ESC] key it will take you back to the previous menu.

## 2.5.4.4. Data transfer

In this mode the saved measurement results from the CCS 4 can be transferred to an external computer. The data can be transferred using the RS232 - interface and the provided RS232 - interface cable and can be displayed and administrated using the data manager software or other evaluation software.

During the measurement the current measurement data are available and presentable by using the data manager software or terminal software like MS HyperTerminal.

A transfer of the storage data can be done using a USB-stick. The data transferred in this way are transferred as TXT – Files.

### 2.5.4.4.1. Transfer of the saved data by RS232

- Transfer of stored measurement data by the RS232 - interface using the data manager software.

**(1) Connect the CCS 4 with the external computer**



- Connect the CCS 4 with the external computer using the RS232 – interface cable.

**(2) Start the data manager software on the external computer.**

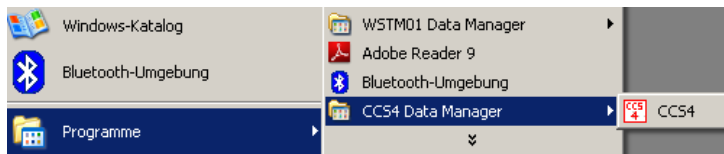

- Access the installed data manager software at the external computer. (One-time installation of the data manager chapter 2.8.1.)

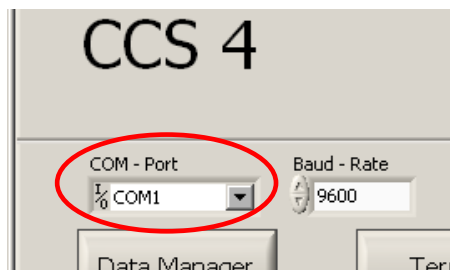

- Select the COM - port at the main menu of the data manager.

**NOTICE** Pay attention that the selected COM – port is consistent with the COM – port indication of the computer. (see in Windows at the device manager in data links “COM and LPT1”)

**(3) Checking the connection or data transfer for processing the data**

- a) Checking the connection between the CCS 4 and the external computer by using the button “Terminal” at the main menu of the data manager software.

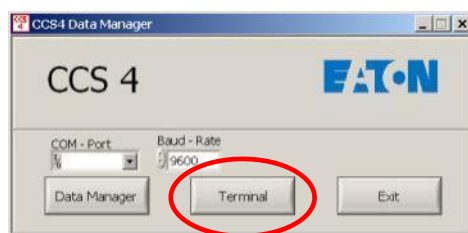

Open „Terminal“.

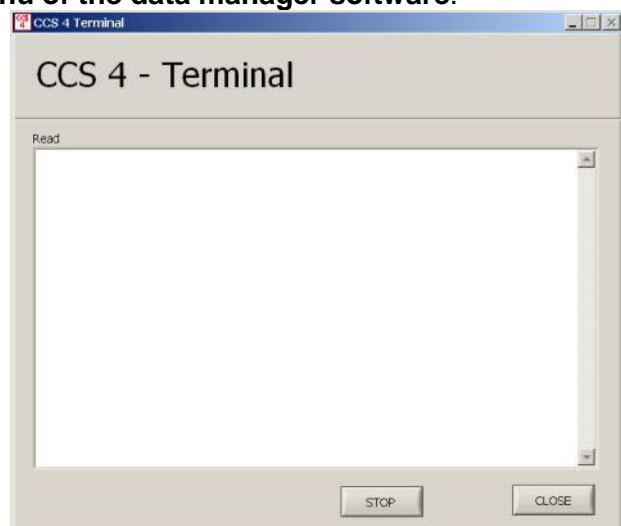

Or

b) Chose „**Data Manager**“ for the data transfer.

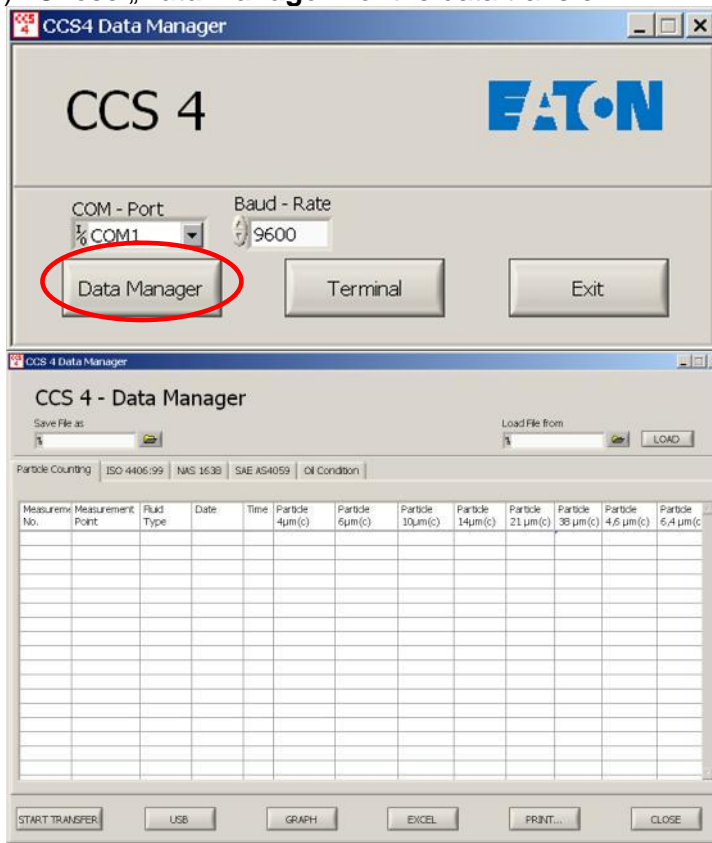

- Clicking the button "**Data Manager**" allows the data transfer and the processing of the transmitted values.

#### (4) Start of the data transfer at the CCS 4

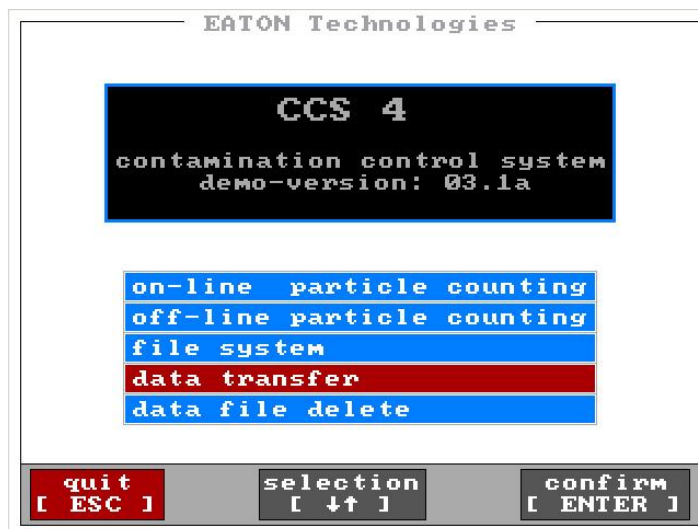

- With the [↓↑] – keys select in the main menu of the CCS 4 the mode “**data manager**” and confirm with [ENTER].

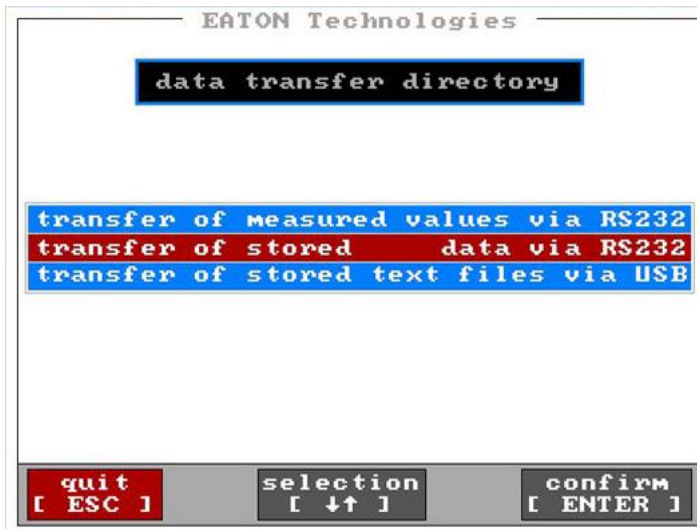

- With the [↓↑] – keys switch to the menu for data transfer of the saved values by using the RS232-interface and confirm with [ENTER].

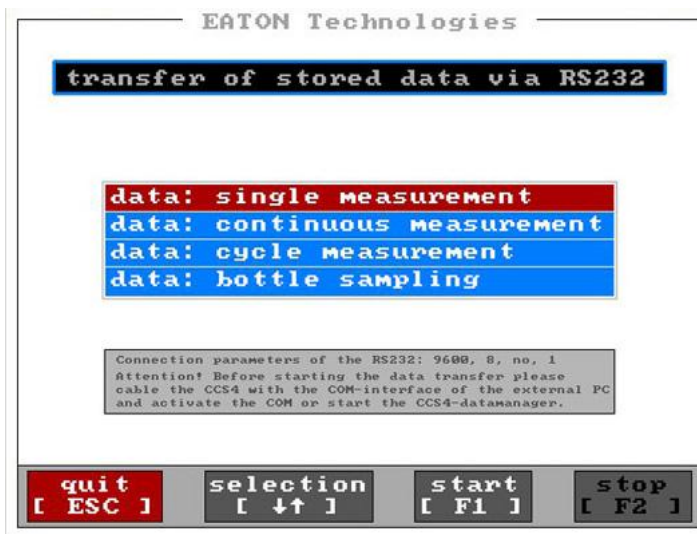

- Select the measuring type by using the [↓↑] – keys. (Selection is highlighted red.)
- Start the data transfer at the CCS 4 by using [F1].
- ⇒ Measuring data of the chosen mode are transferred.
- Stop the data transfer at the CCS 4 with [F2].

##### (5) Display of the transferred data in the data manager

- Transferred data can be displayed as selected in section (3) in "terminal" or "Data Manager" of the data manager program.

###### a) Terminal

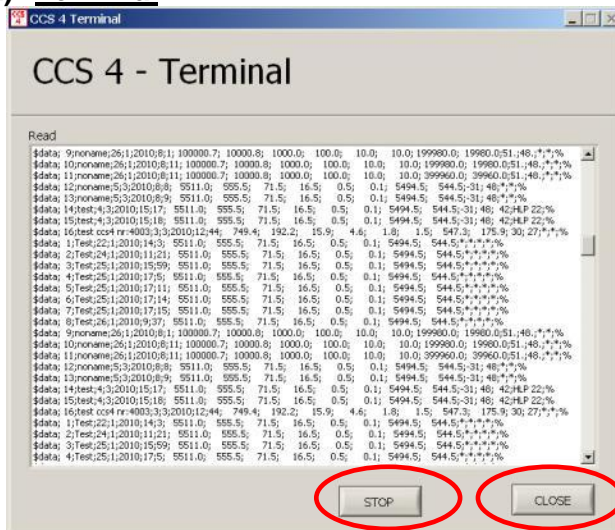

**NOTICE** If an empty terminal window appears, the correct COM-port has to be selected. After changing the COM-port the terminal connection has to be checked again.

- The inspection can be stopped with "STOP" and brought back to the main menu of the data manager with "CLOSE".

## b) Data Manager

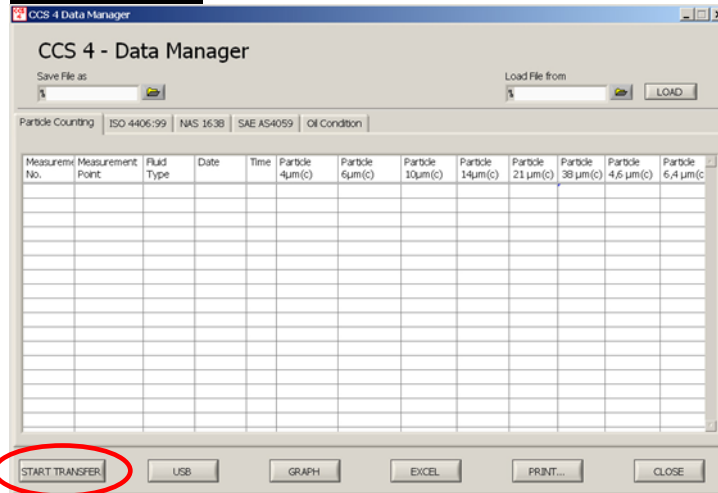

- Start of the data transfer by using the button **“START TRANSFER”**.
  - Select the data path and indicate the file name for the measurements which should be saved. Confirm with **“OK”**.

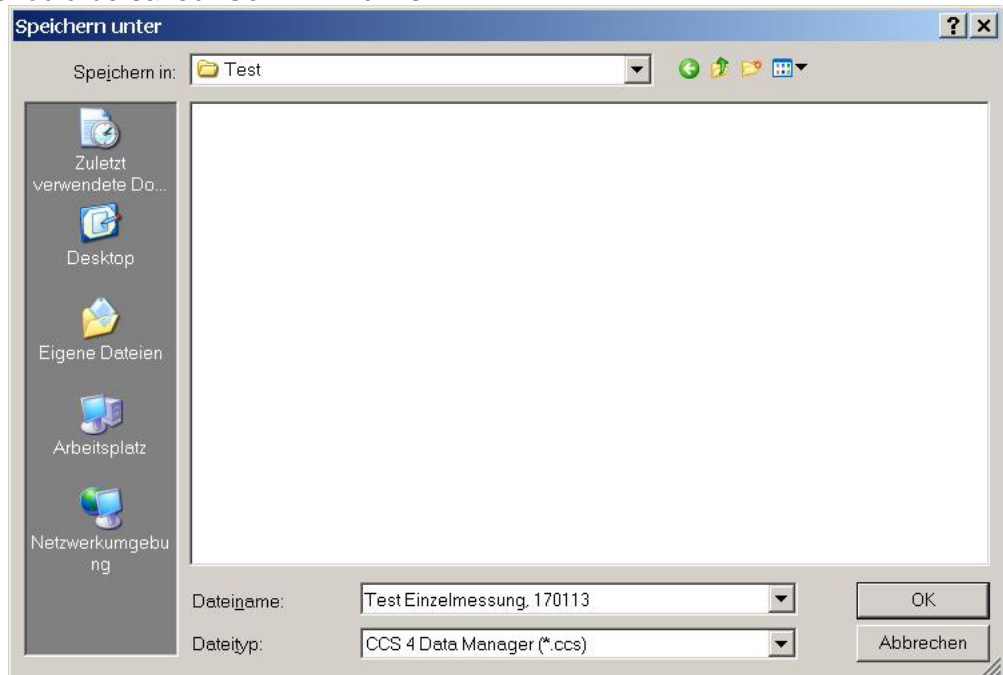

- After that the data transfer starts

- The counted particles, ISO 4406:99, NAS 1638, SAE AS 4059, oil condition can be indicated and processed dependent on the register selection.

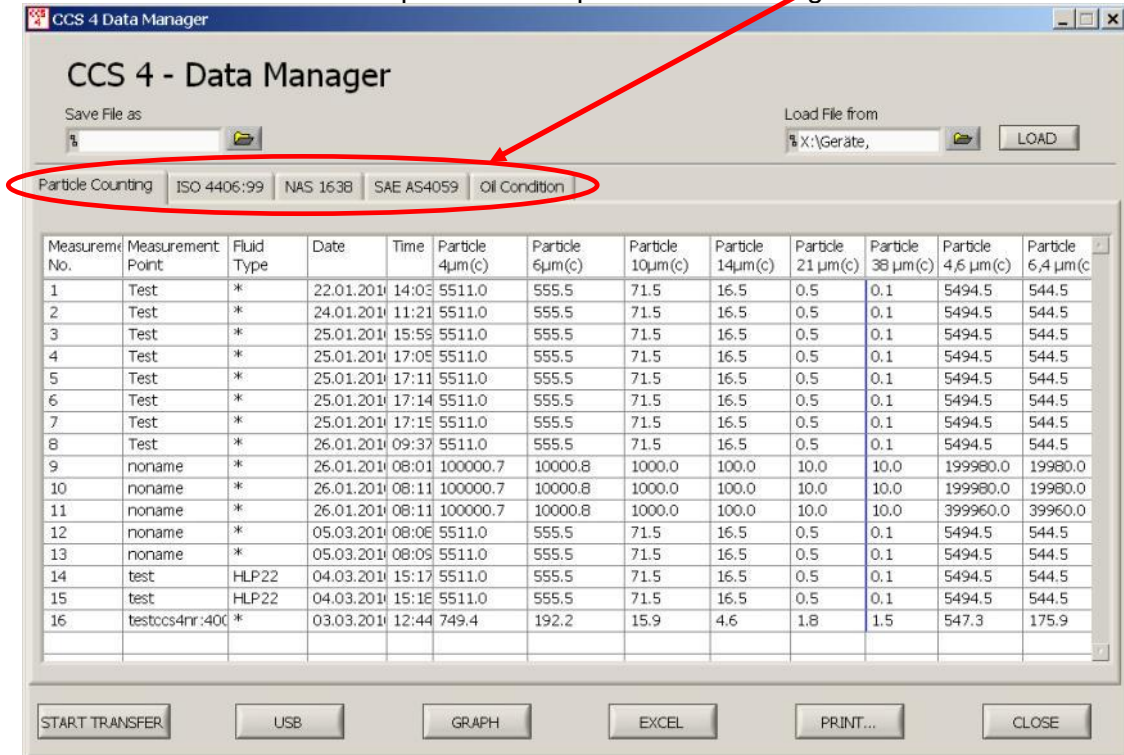

- I. II. III.

**The transferred data can be:**

- I. presented graphically,
- II. exported in a MS EXCEL-chart,
- III. printed as a report.

- I. For graphic presentation use the button “GRAPH”. Depending on the presentation modes, which have been selected in the data manager menu, these are presented graphically.

For example:

*Selection: particle counting*

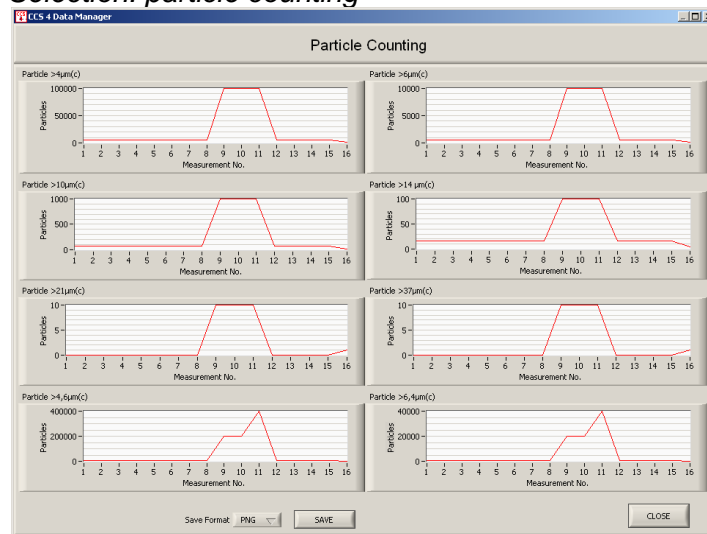

- Display of all counted particles each channel of the selected measuring mode.
- The graph can be saved as PNG- or BMP – file.
- Back to the previous menu by using „CLOSE“.



Selection: NAS 1638

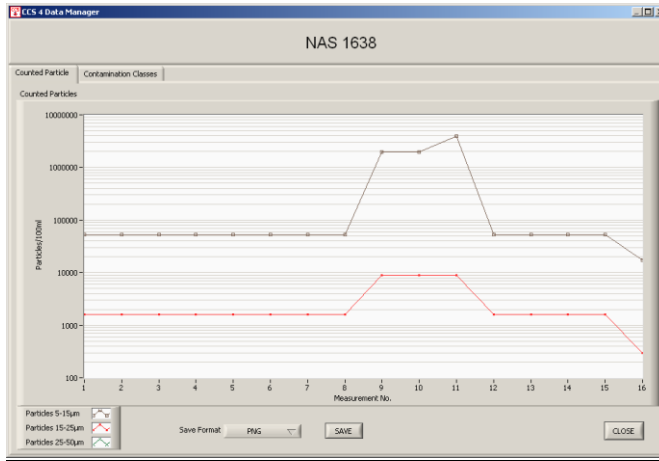

Diagram of the counted particles/ 100 ml

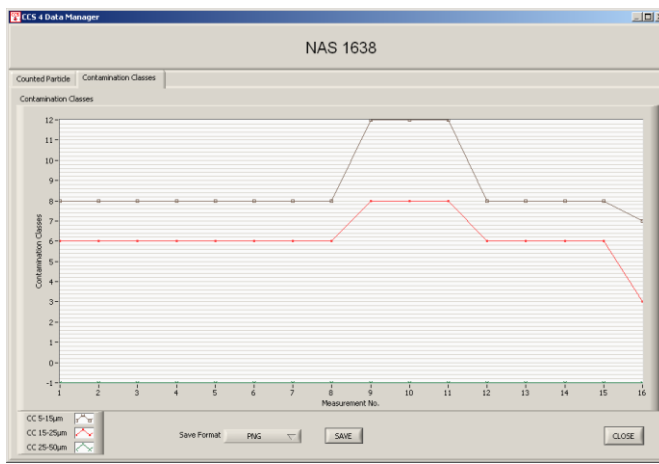
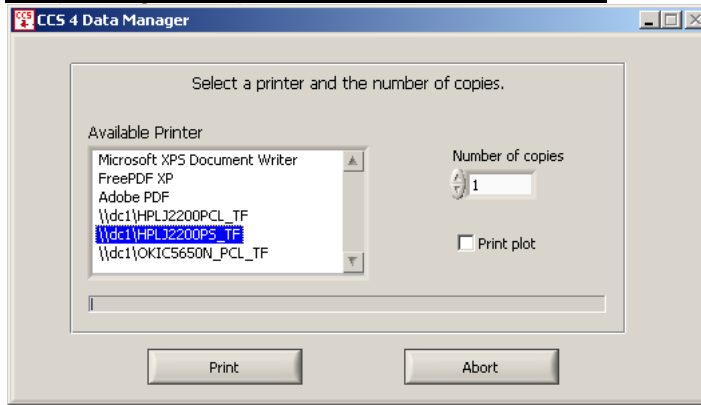

Diagram of the contamination class according to NAS 1638.

II. For export into a MS Excel data sheet use the button **“EXCEL”**  
 For further processing the data all standard functions in MS EXCEL are available.

Measurement No.	Measurement Point	Fluid Type	Date	Time	Particle 4µm(c)	Particle 6µm(c)	Particle 10µm(c)	Particle 14µm(c)	Particle 21µm(c)	Particle 37µm(c)	Particle 4,6µm(c)	Particle 6,4µm(c)
1	Test	*	22.01.2010	14:03	5511	555,5	71,5	16,5	0,5	0,1	5494,5	544,5
2	Test	*	24.01.2010	11:21	5511	555,5	71,5	16,5	0,5	0,1	5494,5	544,5
3	Test	*	25.01.2010	15:59	5511	555,5	71,5	16,5	0,5	0,1	5494,5	544,5
4	Test	*	25.01.2010	17:05	5511	555,5	71,5	16,5	0,5	0,1	5494,5	544,5
5	Test	*	25.01.2010	17:11	5511	555,5	71,5	16,5	0,5	0,1	5494,5	544,5
6	Test	*	25.01.2010	17:14	5511	555,5	71,5	16,5	0,5	0,1	5494,5	544,5
7	Test	*	25.01.2010	17:15	5511	555,5	71,5	16,5	0,5	0,1	5494,5	544,5
8	Test	*	26.01.2010	09:37	5511	555,5	71,5	16,5	0,5	0,1	5494,5	544,5
9	noname	*	26.01.2010	08:01	100000,7	10000,8	1000	100	10	10	199980	19980
10	noname	*	26.01.2010	08:11	100000,7	10000,8	1000	100	10	10	199980	19980
11	noname	*	26.01.2010	08:11	100000,7	10000,8	1000	100	10	10	399960	39960
12	noname	*	05.03.2010	08:08	5511	555,5	71,5	16,5	0,5	0,1	5494,5	544,5
13	noname	*	05.03.2010	08:09	5511	555,5	71,5	16,5	0,5	0,1	5494,5	544,5
14	test	HLP22	04.03.2010	15:17	5511	555,5	71,5	16,5	0,5	0,1	5494,5	544,5
15	test	HLP22	04.03.2010	15:18	5511	555,5	71,5	16,5	0,5	0,1	5494,5	544,5
16	testccs4nr:4003	*	03.03.2010	12:44	749,4	192,2	15,9	4,6	1,8	1,5	547,3	175,9

III. For printing the report use the button **“PRINT”**



- Selection of the printer.

CCS 4 Report

EATON Technologies GmbH

Measurement No.	Measurement Point	Fluid Type	Date	Time	Particle/ml >4µm(c)	Particle/ml >6µm(c)	Particle/ml >14µm(c)	Particle/ml >21µm(c)	ISO 4406:99 > 4µm	ISO 4406:99 > 6µm	ISO 4406:99 > 14µm	ISO 4406:99 > 21µm
1	Test	*	22.01.2010	14:03	5511.0	555.5	16.5	0.5	20	16	11	0
2	Test	*	24.01.2010	11:21	5511.0	555.5	16.5	0.5	20	16	11	0
3	Test	*	25.01.2010	15:59	5511.0	555.5	16.5	0.5	20	16	11	0
4	Test	*	25.01.2010	17:05	5511.0	555.5	16.5	0.5	20	16	11	0
5	Test	*	25.01.2010	17:11	5511.0	555.5	16.5	0.5	20	16	11	0
6	Test	*	25.01.2010	17:14	5511.0	555.5	16.5	0.5	20	16	11	0
7	Test	*	25.01.2010	17:15	5511.0	555.5	16.5	0.5	20	16	11	0
8	Test	*	26.01.2010	09:37	5511.0	555.5	16.5	0.5	20	16	11	0
9	noname	*	26.01.2010	08:01	100000.7	10000.8	100.0	10.0	24	20	14	10
10	noname	*	26.01.2010	08:11	100000.7	10000.8	100.0	10.0	24	20	14	10
11	noname	*	26.01.2010	08:11	100000.7	10000.8	100.0	10.0	24	20	14	10

- Report printing.

(f) For exiting the data manager software use button **“CLOSE”**.

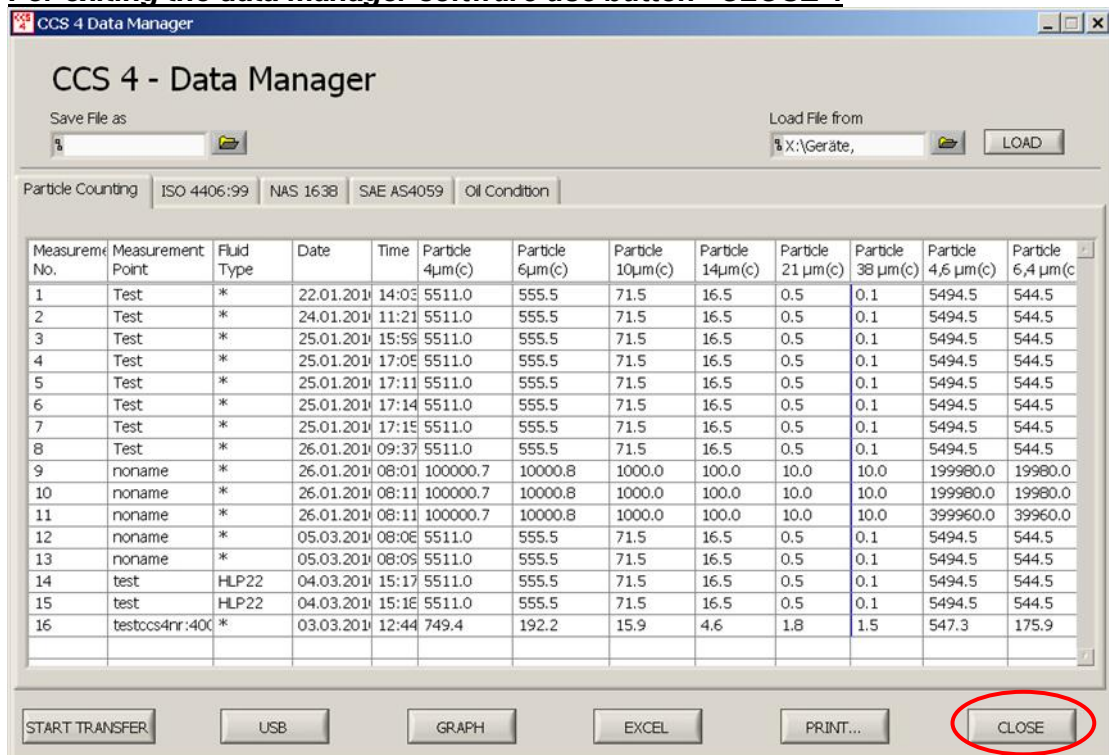

## 2.5.4.4.2. Data transfer of the saved data as TXT-file via USB

- Transfer of the stored measuring data on **USB – stick** (memory capacity: < 2 GB, FAT 16).



- **Load the main menu and then** insert the USB – stick in the USB-connection port of the CCS 4.

**NOTICE** Otherwise the stick has a wrong initialization. ⇒ No data transfer and eventually crash of the CCS 4 software! If a crash occurs, restart it by switching the CCS 4 off and on.

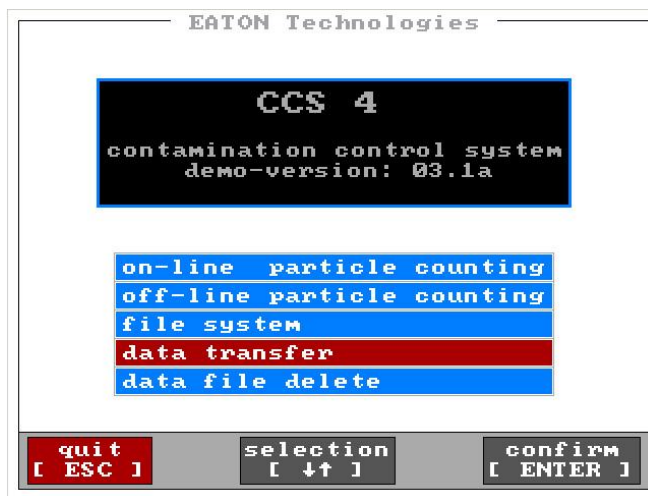

- At the main menu of the CCS 4 select the menu “**data transfer**” with the [↓↑] – keys and confirm with [ENTER].

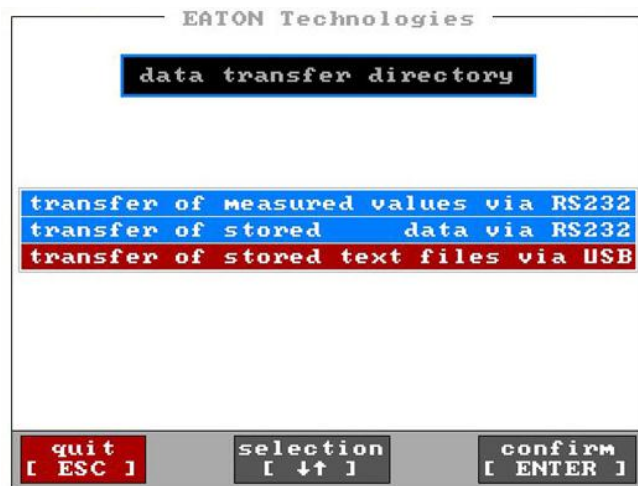

- With the [↓↑] – keys switch to the menu for transferring of the stored TXT-Files via USB.

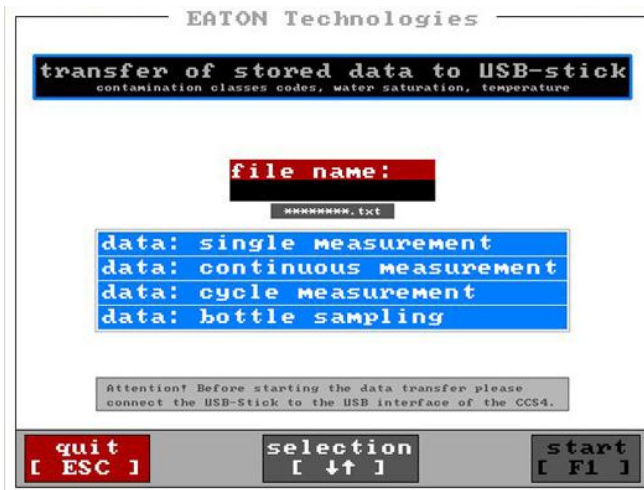

- Input a name as “file name “.
- Pay attention: with the file name the file format (.txt) has to be indicated, too. For example: test.txt

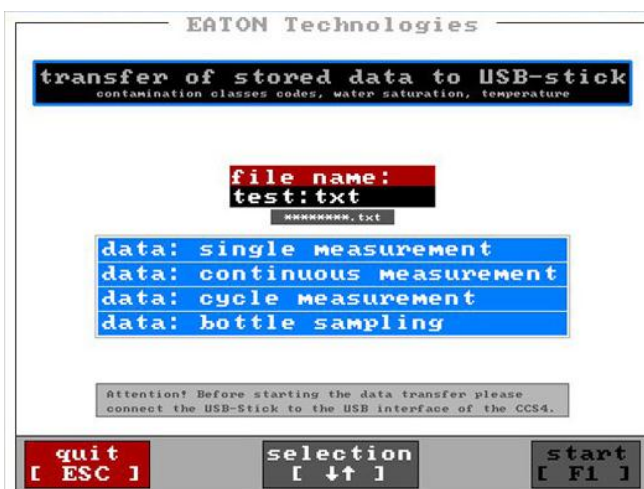

- Select data which are to be transferred with the [ ↓↑ ]-keys. (The selection is highlighted red.)

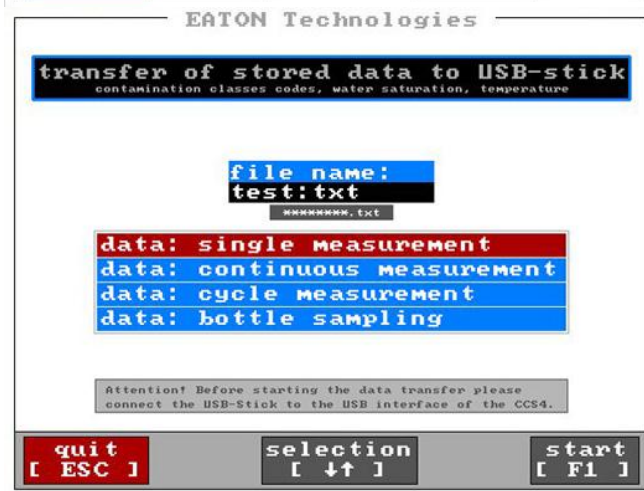

- Start the data transfer with [F1].

- The text file is generated, stored on the USB-stick and can be transferred and displayed by using the data manager software.

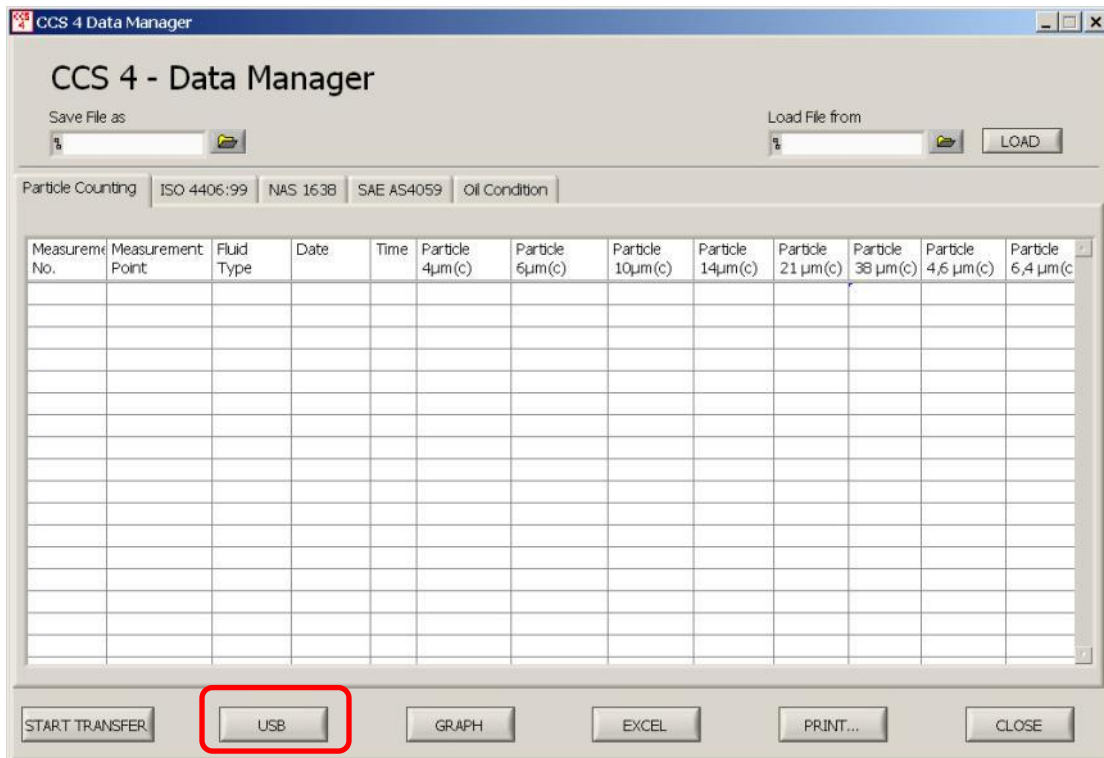

### 2.5.4.4.2.1. Data transfer from the USB – stick to the computer by using the data manager software

(1) Insert the USB-Stick in the USB – connection port of the computer.

(2) Start the data manager software on the external computer.

- Access the installed data manager software at the external computer. (one-time installation of the data manager software in chapter 2.8)

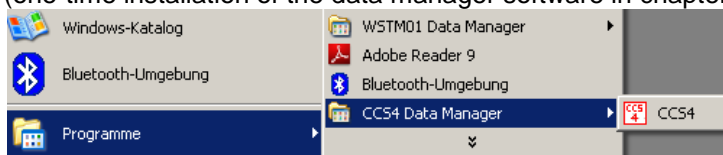

- No COM – port selected at the main menu of the data manager.
- Chose the button „**Data Manager**“ allows the data transfer and the processing of the transmitted values.
- Chose „**Data Analysis**“.



(3) **Start the data transfer by using the button [USB].**

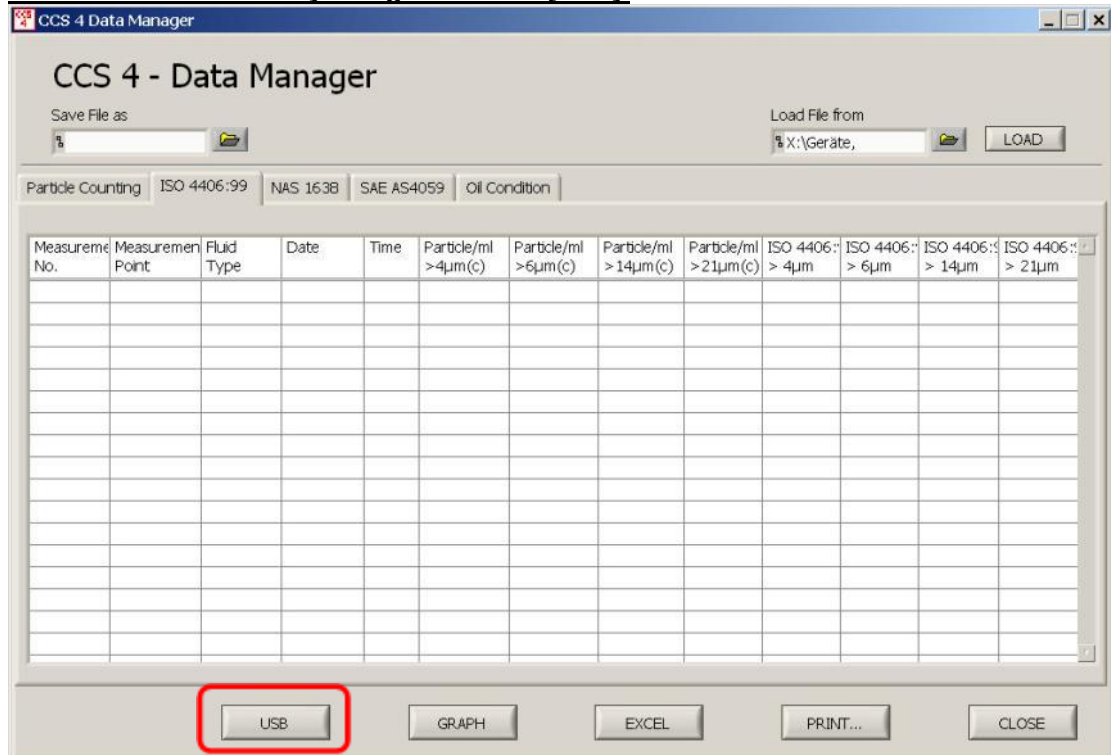

(4) **Presse „OK“ to delete the current data.**

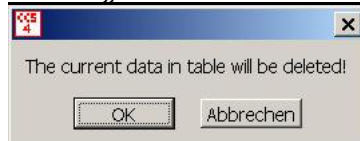

(5) **Select the data path, chose the TXT – file from the USB-stick and confirm with „OK“:**

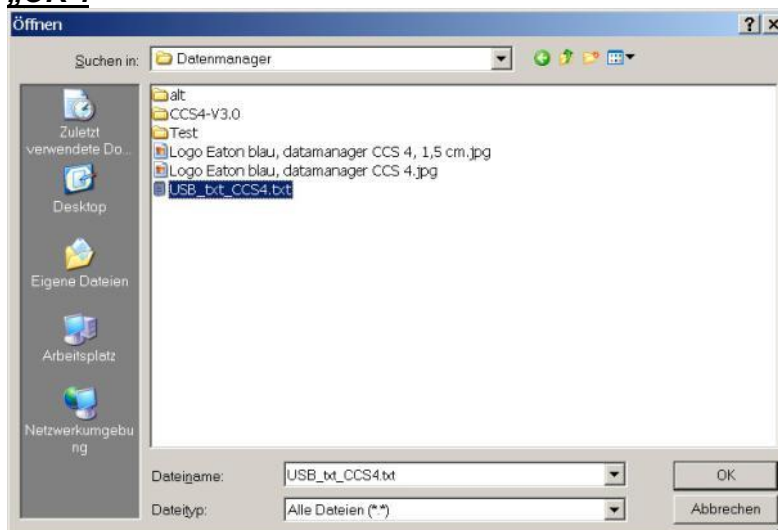

(6) **After that the data transfer starts.**

- ISO 4406:99, NAS 1638, SAE AS 4059, Oil Condition should be displayed and processed dependent on the register selection.

**Attention: The counted particles are not displayed.**

CCS 4 Data Manager

Save File as:

Load File from: X:\Geräte,

Particle Counting: **ISO 4406:99** NAS 1638 SAE AS4059 Oil Condition

Measurement No.	Measurement Point	Fluid Type	Date	Time	Particle/ml >4µm(c)	Particle/ml >6µm(c)	Particle/ml >14µm(c)	Particle/ml >21µm(c)	ISO 4406: > 4µm	ISO 4406: > 6µm	ISO 4406: > 14µm	ISO 4406: > 21µm
1	spuelen nr.:2087	HLP 22	15.12.2011	15:16					20	18	14	
2	spuelen nr.:2087	HLP 22	15.12.2011	15:17					20	18	13	
3	spuelen nr.:2087	HLP 22	15.12.2011	15:17					20	17	13	
4	spuelen nr.:2087	HLP 22	15.12.2011	15:18					19	17	13	
5	spuelen nr.:2087	HLP 22	15.12.2011	15:18					19	17	13	
6	spuelen nr.:2087	HLP 22	15.12.2011	15:18					19	17	13	
7	spuelen nr.:2087	HLP 22	15.12.2011	15:19					19	17	12	
8	spuelen nr.:2087	HLP 22	15.12.2011	15:19					19	17	13	
9	spuelen nr.:2087	HLP 22	15.12.2011	15:20					19	17	12	
10	spuelen nr.:2087	HLP 22	15.12.2011	15:20					19	17	12	
11	spuelen nr.:2087	HLP 22	15.12.2011	15:21					19	17	12	
12	spuelen nr.:2087	HLP 22	15.12.2011	15:21					19	17	13	
13	spuelen nr.:2087	HLP 22	15.12.2011	15:21					19	16	12	
14	spuelen nr.:2087	HLP 22	15.12.2011	15:22					19	16	12	
15	spuelen nr.:2087	HLP 22	15.12.2011	15:22					18	16	12	
16	spuelen nr.:2087	HLP 22	15.12.2011	15:23					18	16	12	
17	spuelen nr.:2087	HLP 22	15.12.2011	15:23					18	16	12	

Buttons: USB, GRAPH, EXCEL, PRINT..., CLOSE

CCS 4 Data Manager

Save File as:

Load File from: X:\Geräte,

Particle Counting: **ISO 4406:99** NAS 1638 SAE AS4059 Oil Condition

Measurement No.	Measurement Point	Fluid Type	Date	Time	Temperature [°C]	Temperature [°F]	Saturation [%]	Content [ppm]
1	spuelen nr.:2087	HLP 22	15.12.2011	15:16	22	71,6	55	144
2	spuelen nr.:2087	HLP 22	15.12.2011	15:17	22	71,6	55	142
3	spuelen nr.:2087	HLP 22	15.12.2011	15:17	22	71,6	54	142
4	spuelen nr.:2087	HLP 22	15.12.2011	15:18	22	71,6	54	142
5	spuelen nr.:2087	HLP 22	15.12.2011	15:18	23	73,4	53	140
6	spuelen nr.:2087	HLP 22	15.12.2011	15:18	23	73,4	53	138
7	spuelen nr.:2087	HLP 22	15.12.2011	15:19	23	73,4	52	137
8	spuelen nr.:2087	HLP 22	15.12.2011	15:19	23	73,4	52	137
9	spuelen nr.:2087	HLP 22	15.12.2011	15:20	23	73,4	52	138
10	spuelen nr.:2087	HLP 22	15.12.2011	15:20	23	73,4	51	136
11	spuelen nr.:2087	HLP 22	15.12.2011	15:21	23	73,4	51	135
12	spuelen nr.:2087	HLP 22	15.12.2011	15:21	23	73,4	50	133
13	spuelen nr.:2087	HLP 22	15.12.2011	15:21	23	73,4	49	132
14	spuelen nr.:2087	HLP 22	15.12.2011	15:22	24	75,2	49	132
15	spuelen nr.:2087	HLP 22	15.12.2011	15:22	24	75,2	49	130
16	spuelen nr.:2087	HLP 22	15.12.2011	15:23	24	75,2	48	129
17	spuelen nr.:2087	HLP 22	15.12.2011	15:23	24	75,2	47	127

Buttons: USB, GRAPH, EXCEL, PRINT..., CLOSE

**The transferred data can be:**

- I. Presented graphically**
- II. Exported in a MS EXCEL - chart**
- III. Printed as a report**

- I. For graphic presentation use the button „GRAPH“.
- Depending on the presentation modes, which have been selected in the data manager menu, these are presented graphically.

For example:

*Selection: Particle counting*

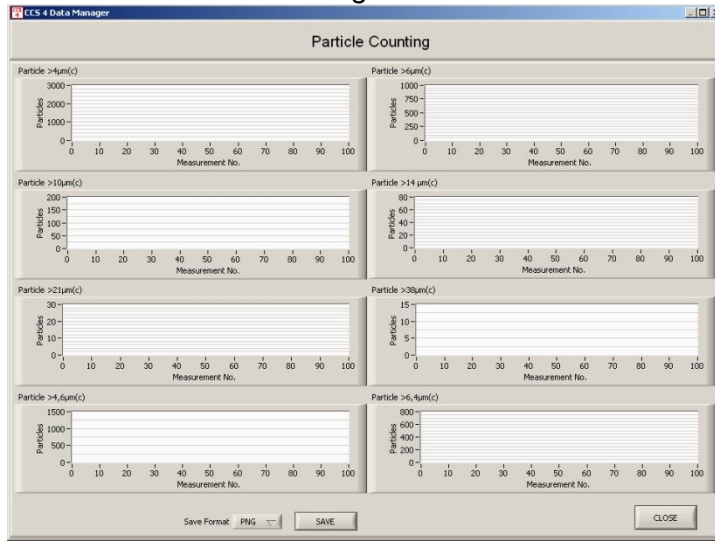

- Particles per counter channel of all measurements of the selected measurement mode **are not displayed**
- Back to the previous menu by using „CLOSE“.

*Selection: ISO 4406:99*



**No display** of the counted particles per 1 ml.

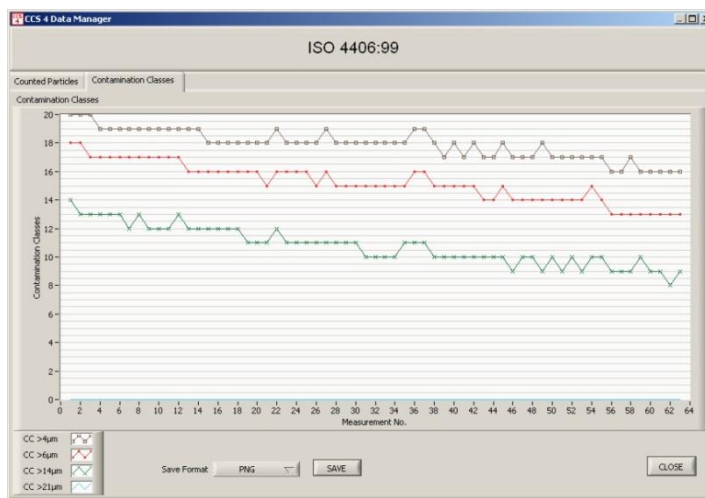

Display of the contamination classes according to ISO 4406:99.



## II. Export in a Excel – data sheet by using the button „EXCEL“

- For further processing the data all standard functions in MS EXCEL are available.

Measurement No.	Measurement Point	Fluid Type	Date	Time	Particle/ml >4µm(c)	Particle/ml >6µm(c)	Particle/ml >14µm(c)	Particle/ml >21µm(c)	ISO 4406:99 >4µm	ISO 4406:99 >6µm	ISO 4406:99 >14µm	ISO 4406:99 >21µm
1	spuelen nr.:2087	HLP 22	15.12.2011	15:16					20	18	14	
2	spuelen nr.:2087	HLP 22	15.12.2011	15:17					20	18	13	
3	spuelen nr.:2087	HLP 22	15.12.2011	15:17					20	17	13	
4	spuelen nr.:2087	HLP 22	15.12.2011	15:18					19	17	13	
5	spuelen nr.:2087	HLP 22	15.12.2011	15:18					19	17	13	
6	spuelen nr.:2087	HLP 22	15.12.2011	15:18					19	17	13	
7	spuelen nr.:2087	HLP 22	15.12.2011	15:19					19	17	12	
8	spuelen nr.:2087	HLP 22	15.12.2011	15:19					19	17	13	
9	spuelen nr.:2087	HLP 22	15.12.2011	15:20					19	17	12	
10	spuelen nr.:2087	HLP 22	15.12.2011	15:20					19	17	12	
11	spuelen nr.:2087	HLP 22	15.12.2011	15:21					19	17	12	
12	spuelen nr.:2087	HLP 22	15.12.2011	15:21					19	17	13	
13	spuelen nr.:2087	HLP 22	15.12.2011	15:21					19	17	13	
14	spuelen nr.:2087	HLP 22	15.12.2011	15:21					19	16	12	
15	spuelen nr.:2087	HLP 22	15.12.2011	15:22					19	16	12	
16	spuelen nr.:2087	HLP 22	15.12.2011	15:22					18	16	12	
17	spuelen nr.:2087	HLP 22	15.12.2011	15:22					18	16	12	
18	spuelen nr.:2087	HLP 22	15.12.2011	15:22					18	16	12	
19	spuelen nr.:2087	HLP 22	15.12.2011	15:23					18	16	12	
20	spuelen nr.:2087	HLP 22	15.12.2011	15:23					18	16	12	
21	spuelen nr.:2087	HLP 22	15.12.2011	15:24					18	16	12	
22	spuelen nr.:2087	HLP 22	15.12.2011	15:24					18	16	11	
23	spuelen nr.:2087	HLP 22	15.12.2011	15:24					18	16	11	
24	spuelen nr.:2087	HLP 22	15.12.2011	15:25					18	15	11	
25	spuelen nr.:2087	HLP 22	15.12.2011	15:25					19	16	12	
26	spuelen nr.:2087	HLP 22	15.12.2011	15:26					18	16	11	
27	spuelen nr.:2087	HLP 22	15.12.2011	15:26					18	16	11	
28	spuelen nr.:2087	HLP 22	15.12.2011	15:26					18	16	11	
29	spuelen nr.:2087	HLP 22	15.12.2011	15:27					18	15	11	
30	spuelen nr.:2087	HLP 22	15.12.2011	15:27					19	16	11	
31	spuelen nr.:2087	HLP 22	15.12.2011	15:28					18	15	11	
32	spuelen nr.:2087	HLP 22	15.12.2011	15:28					18	15	11	
33	spuelen nr.:2087	HLP 22	15.12.2011	15:29					18	15	11	
34	spuelen nr.:2087	HLP 22	15.12.2011	15:29					18	15	10	
35	spuelen nr.:2087	HLP 22	15.12.2011	15:30					18	15	10	

## III. Print the report by using the button „PRINT“

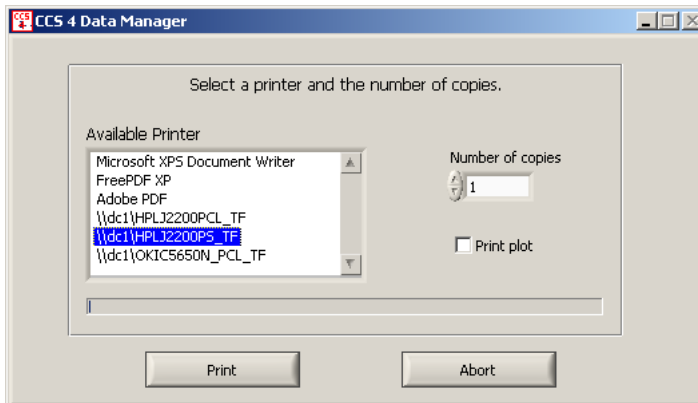

- Selection of the printer.

### CCS 4 Report

EATON Technologies GmbH

Measurement No.	Measurement Point	Fluid Type	Date	Time	Particle/ml >4µm(c)	Particle/ml >6µm(c)	Particle/ml >14µm(c)	Particle/ml >21µm(c)	ISO 4406:99 >4µm	ISO 4406:99 >6µm	ISO 4406:99 >14µm	ISO 4406:99 >21µm
1	spuelen nr.:2087	HLP 22	15.12.2011	15:16					20	18	14	
2	spuelen nr.:2087	HLP 22	15.12.2011	15:17					20	18	13	
3	spuelen nr.:2087	HLP 22	15.12.2011	15:17					20	17	13	
4	spuelen nr.:2087	HLP 22	15.12.2011	15:18					19	17	13	
5	spuelen nr.:2087	HLP 22	15.12.2011	15:18					19	17	13	
6	spuelen nr.:2087	HLP 22	15.12.2011	15:18					19	17	13	
7	spuelen nr.:2087	HLP 22	15.12.2011	15:19					19	17	12	
8	spuelen nr.:2087	HLP 22	15.12.2011	15:19					19	17	13	
9	spuelen nr.:2087	HLP 22	15.12.2011	15:20					19	17	12	
10	spuelen nr.:2087	HLP 22	15.12.2011	15:20					19	17	12	
11	spuelen nr.:2087	HLP 22	15.12.2011	15:21					19	17	12	

- Report-printing

(7) For exiting the data manager software use Button „CLOSE“.

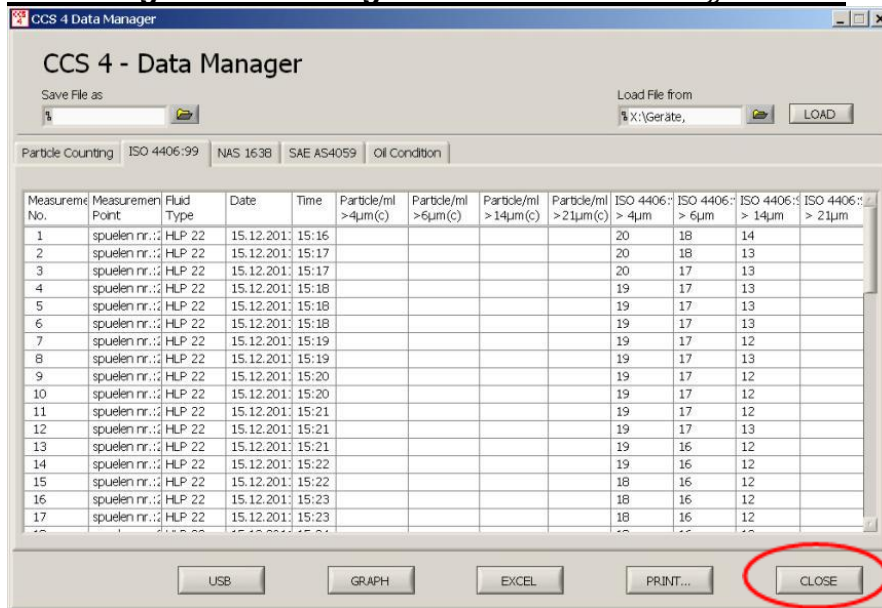

### 2.5.4.4.3. Continuous transfer of the current measurement values

During the measurements, the actual measured values can be continuously transferred from the CCS 4 to an external computer. In order to do so, the CCS 4 has to be connected to the external computer by using the RS232-interface cable and the format for the data transfer has to be defined in the mode „**data transfer – transfer of measured values via RS232**“. The output results can be displayed on the computer by a communication program (“HyperTerminal by Microsoft”) or "Terminal" of the data manager software.

#### 2.5.4.4.3.1. HyperTerminal

The HyperTerminal is a communication program, which is starting with the version 2.0, provided with the Windows operating system. The HyperTerminal connections can be made between a computer and a measuring unit, which are connected by serial interfaces (for example between a computer and the CCS 4). In Windows Vista, HyperTerminal is no longer included. **Initial configuration of HyperTerminal see chapter 2.7.**

#### 2.5.4.4.3.2. Definition of the data transfer rate

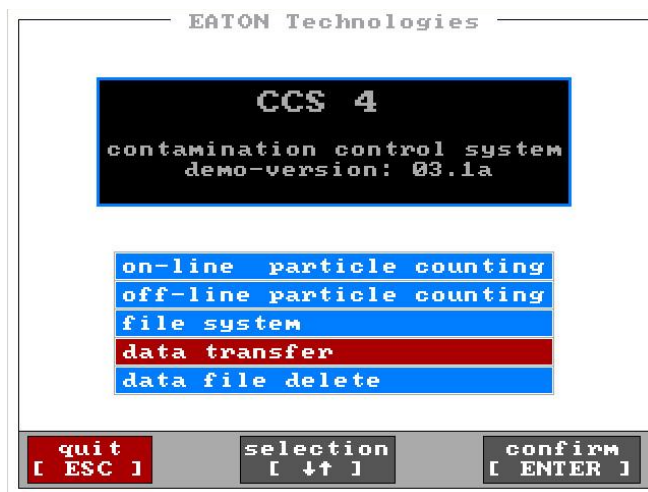

- In the main menu of the CCS 4 select the menu „data transfer“ by using the [↑↓] – keys and confirm with [ENTER].

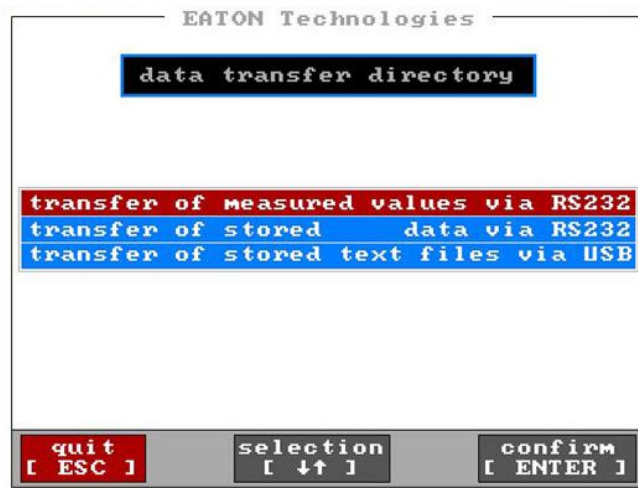

- With the [↓↑] – keys switch to the menu „transfer of measured values via RS232“ and confirm with [ENTER].

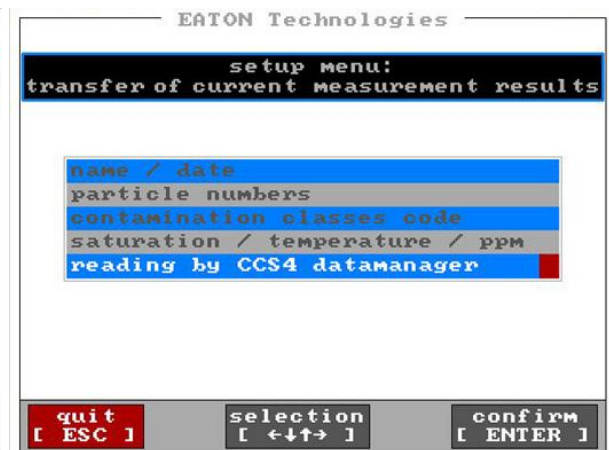
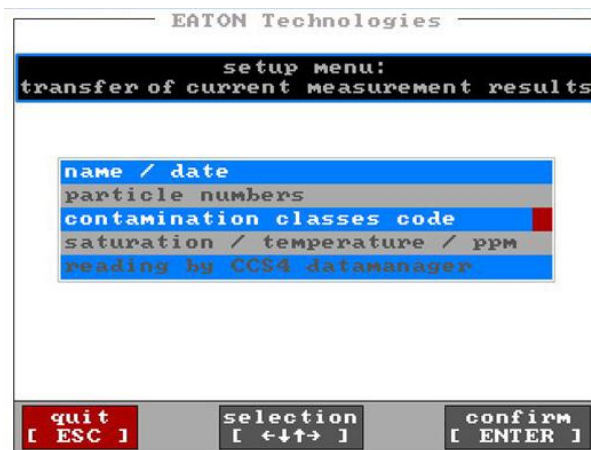

- Select with the [↓↑] – keys, which parameters are to be shown and activate with the [← →] – keys. (The selected parameter appears white.)

### 2.5.4.4.3.3. Procedure

- Connect the CCS 4 with the external computer (RS232).
- Select and start the measuring mode (on-line or off-line) in the main menu of the CCS 4.
- The current measured data are provided at the RS232-interface and are displayed in the terminal program according to „**data transfer – transfer of measured values via RS232**“ defined notation after a few seconds.

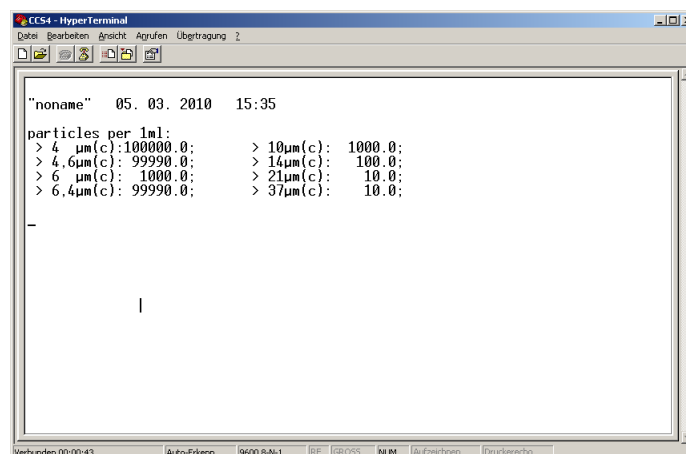

- Notation of „data transfer – transfer of measured values via RS232“  
**selection of single parameters.**

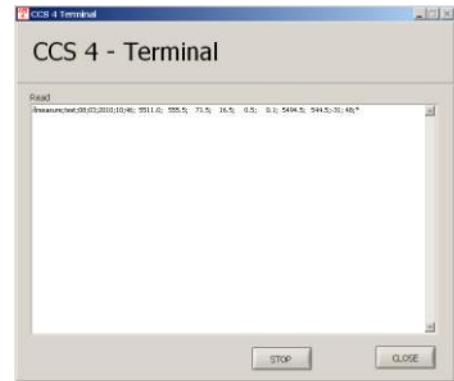
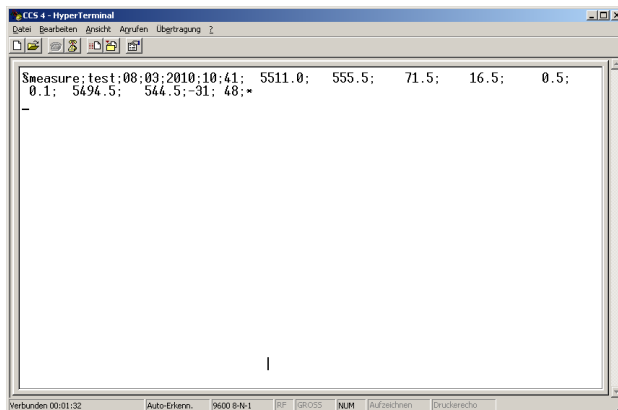

- Notation of „data transfer – transfer of measured values via RS232“  
**selection of “reading by CCS 4 data manager”.**

**Attention:** No data transfer if in „data transfer – transfer of measured values via RS232“ no selection has been made! Minimum 1 parameter needs to be selected (visible as white font).

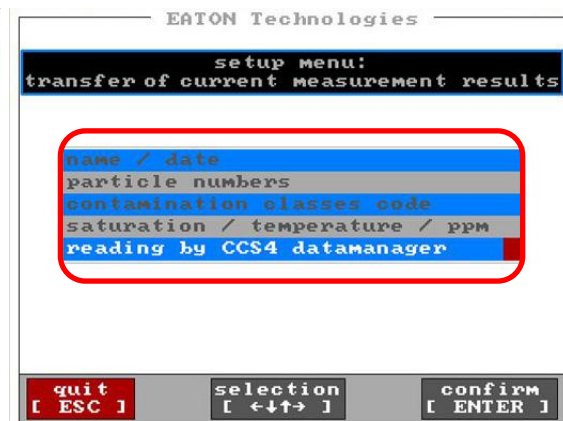
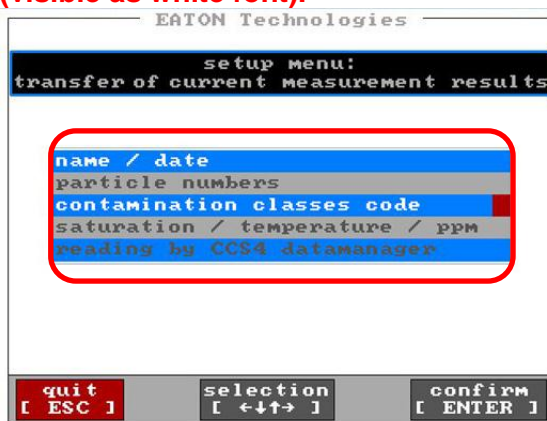

#### 2.5.4.4.3.4. Protocol of the continuous data transfer

The data telegrams are generally constructed as follows:

**\$cmd(;par;par)%**

- \$ Marks the beginning of a data telegram
- cmd Instruction
- ; Separator
- par Parameter for the instruction
- \* Marks the end of the data telegram

**Measurement results are displayed dependent on the selected notation as follows:**

- a) If “reading by CCS 4 data manager“ has been selected in the „data transfer – transfer of measured values via RS232“ (see chapter 2.5.4.4.3.2 also), the following parameters are displayed in the HyperTerminal:

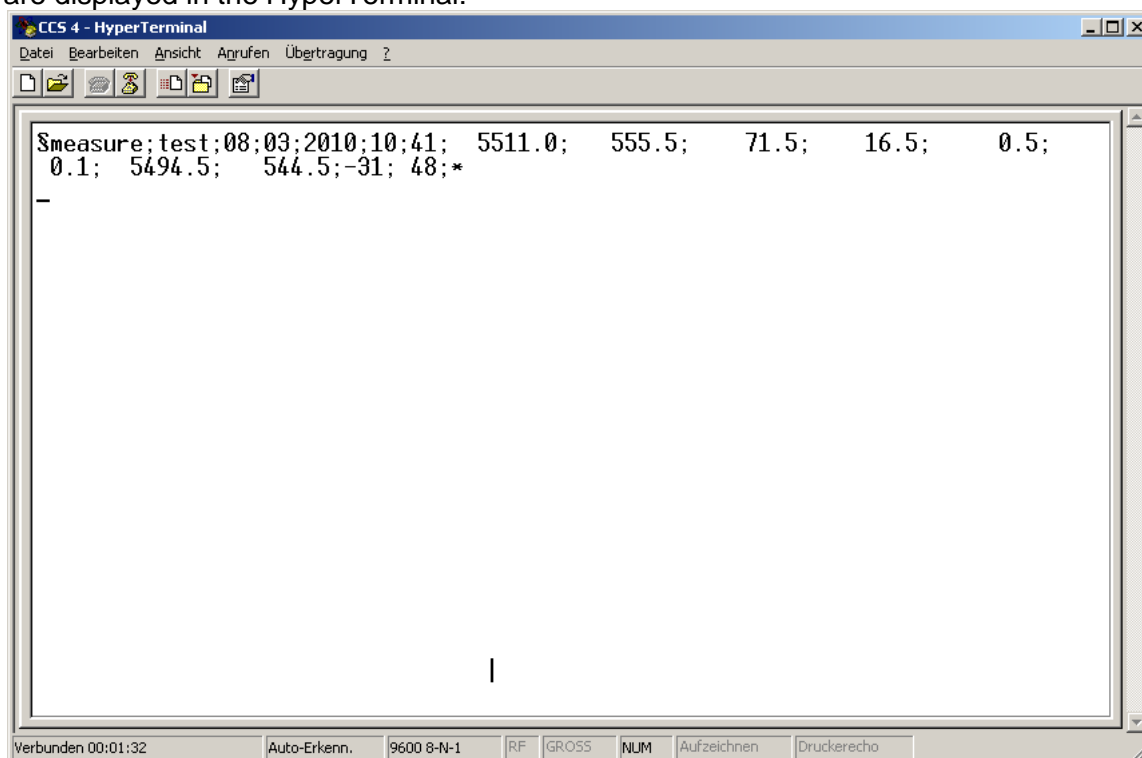

**\$measure;P;dd;mm;yyyy;HH;MM;a.aa;b.bb;c.cc;d.dd;e.ee;f.ff;g.gg;i.ii;ww.w;pp;tt.t;F;\***

**Meaning:**

**\$measure:** Display the beginning of a new data field  
**P:** Measuring point indication  
**dd:** Day (Date)  
**mm:** Month (Date)  
**yyyy:** Year (Date)  
**HH:** Hour (Time)  
**MM:** Minute (Time)  
**a.aa:** Particle per 1 ml ( $\geq 4 \mu\text{m}_{(c)}$ )  
**b.bb:** Particle per 1 ml ( $\geq 6 \mu\text{m}_{(c)}$ )  
**c.cc:** Particle per 1 ml ( $\geq 10 \mu\text{m}_{(c)}$ )  
**d.dd:** Particle per 1 ml ( $\geq 14 \mu\text{m}_{(c)}$ )  
**e.ee:** Partikel pro 1 ml ( $\geq 21 \mu\text{m}_{(c)}$ )  
**f.ff:** Particle per 1 ml ( $\geq 37 \mu\text{m}_{(c)}$ )  
**g.gg:** Particle per 1 ml ( $\geq 4,6 \mu\text{m}_{(c)}$ )  
**i.ii:** Particle per 1 ml ( $\geq 6,4 \mu\text{m}_{(c)}$ )  
**ww.w:** Water saturation (%)  
**pp:** ppm water content  
**tt.t:** Temperature ( $^{\circ}\text{C}/^{\circ}\text{F}$ )  
**F:** Kind of fluid  
**\***: Indicates the end of a data field.

- b) In case of selecting separate parameters in the menu „**data transfer – transfer of measured values via RS232**“ (see chapter 2.5.4.4.3.2 too) only the selected parameters will be displayed in HyperTerminal:

Example: Selection of **name/ date, particle numbers**

```

"noname" 05. 03. 2010 15:35
particles per 1ml:
> 4 µm(c):100000.0; > 10µm(c): 1000.0;
> 4.6µm(c): 99990.0; > 14µm(c): 100.0;
> 6 µm(c): 1000.0; > 21µm(c): 10.0;
> 6.4µm(c): 99990.0; > 37µm(c): 10.0;
  
```

Measurement values are indicated in a **report format**, here: measuring point, date, time, particles / 1 ml

## 2.5.4.5. Data file delete and setting of date/ time

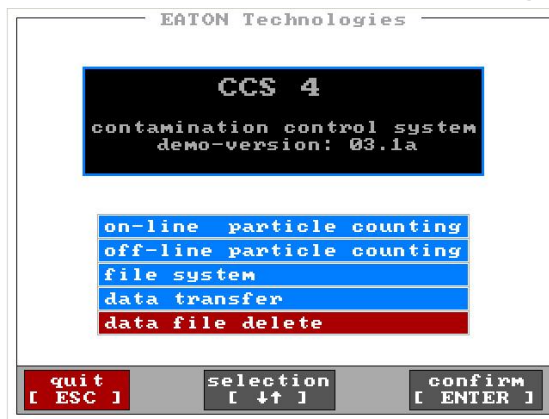

- Select in the main menu of the CCS 4 the menu „**data file delete**“ by using the [↑↓] – keys and confirm with [ENTER].

### 2.5.4.5.1. Delete files

By using this function you will be **deleting the complete data files from the specific storage of the measuring type and this deleting is irreversible!**

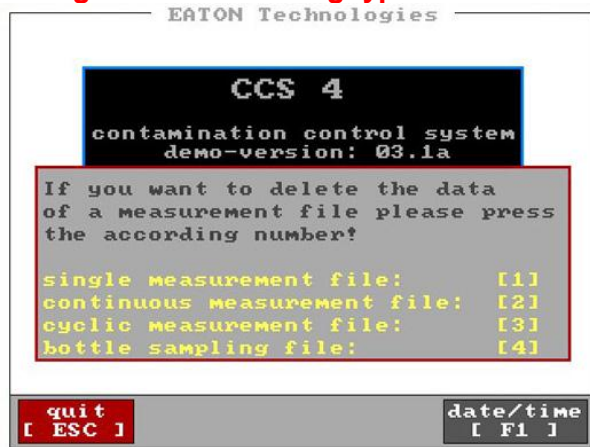

- With [ESC] back to the main menu.

Select

[ 1 ] to delete the complete single measurement files.

[ 2 ] to delete the complete continuous measurement files.

[ 3 ] to delete the complete cyclic measurement files.

[ 4 ] to delete the complete bottle sampling file.

## 2.5.4.5.2. Date/ time

- This function is meant for setting the real time clock integrated within the device. Through the battery backup it continues to run even if the power supply is switched off.
- Day, month, hour and minute are separately adaptable and are getting transferred to the real time clock.

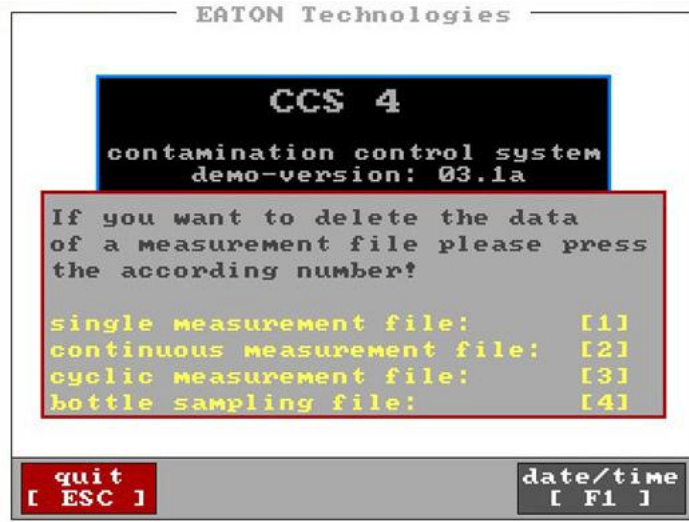

- With the [ F1 ] switch to the menu "date / time".

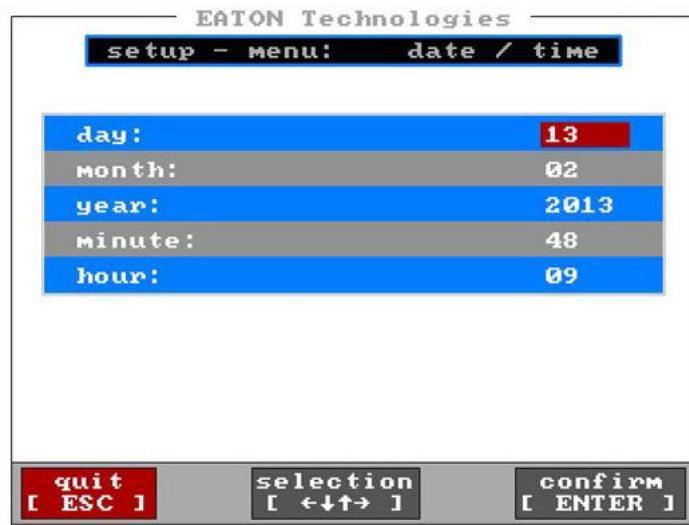

- Select the parameter to be changed with the [ ↓↑ ] – keys. (The selected parameter is highlighted red.)
- Set the parameter with the [ ← → ] – keys to the current date and / or time.

- After all parameters are set, confirm the selection with [ENTER].  
⇒ An automatic alteration to the previous menu will occur.

## 2.6. Printer

### 2.6.1. Installation of new paper rolls

- Open the front side of the printer and remove the empty printer paper roll.



- Place a new roll in.



- Close the cover of the printer.





## 2.7. Set up of the HyperTerminal

- One time set up of the HyperTerminal:  
**START / PROGRAMS / ACCESSORIES / COMMUNICATION / HYPERTERMINAL**

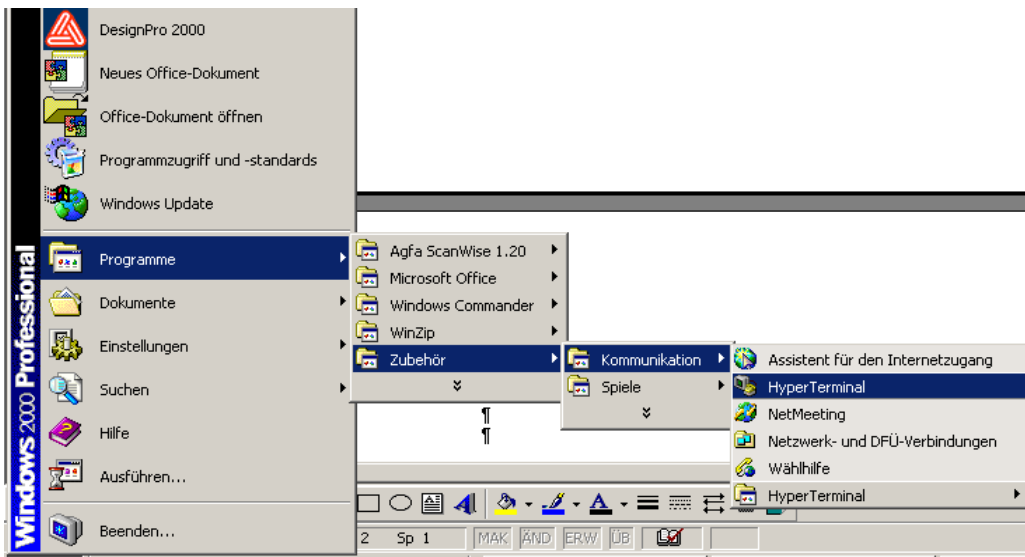

- Select a symbol, enter any name (for example CCS 4) and confirm with **OK**.

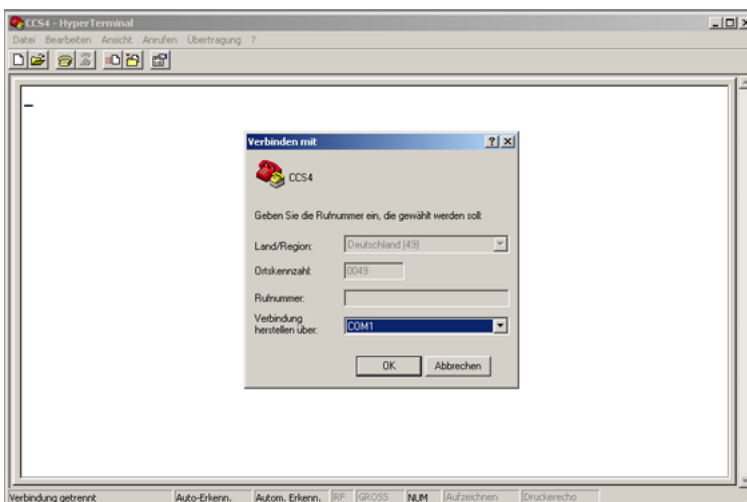

- Select COM-port interface and press **OK**.

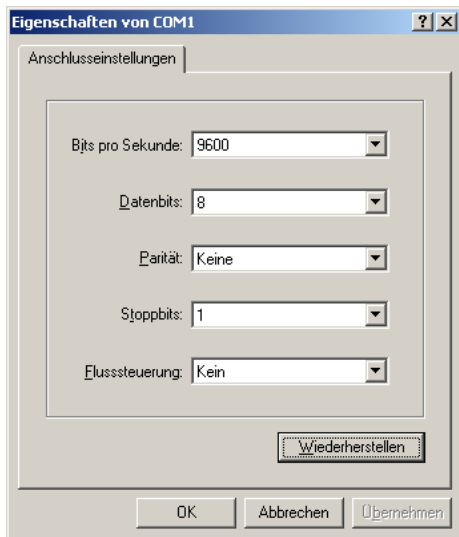

- Set up the transfer conditions at the computer as follows:

Bits per second:	9600 Bits
Data bits:	8
Parity:	none
Stop bits:	1
Flow control:	hardware or none

## 2.8. Installation of the Data Manager Software at an external PC

The CCS 4 DATA MANAGER software was especially developed for the CCS 4 and is provided on the included CD-ROM.

The **one-time installation** of the data manager software from the CD-ROM to the external computer is necessary. The data manager enables the data transfer to a MS Excel data sheet.

### 2.8.1. One-time program installation

- Execute CCS 4 – data manager program installation (**setup.exe**) from the provided CD-ROM. The **setup.exe** is located in the following folder on the CD-ROM: **setup\ Volume1\ setup.exe**
- Execute the installation as instructed and wait until the installation has been completely finished.
- In the Windows - START-menu, the folder “CCS 4 data manager“ will be generated. In this folder the data manager program “**CCS 4 Data Manager**” is saved.
- Start the data manager program from an external computer with:  
**CCS 4\_Datamanager.**

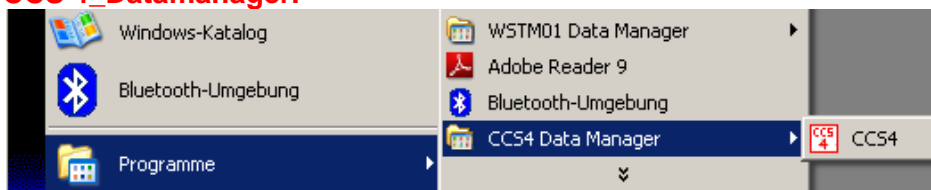

## 2.9. CCS 4 - software update (filelink)

The DOS-program “**filelink**” is needed to install a new program version on the CCS 4.

The program is provided on the CD-ROM of the data manager. Installation of this program at the computer which is intended for the data transfer.

### Data transfer:

- Switch on the CCS 4.
- Leave the main menu with [ **ESC** ].

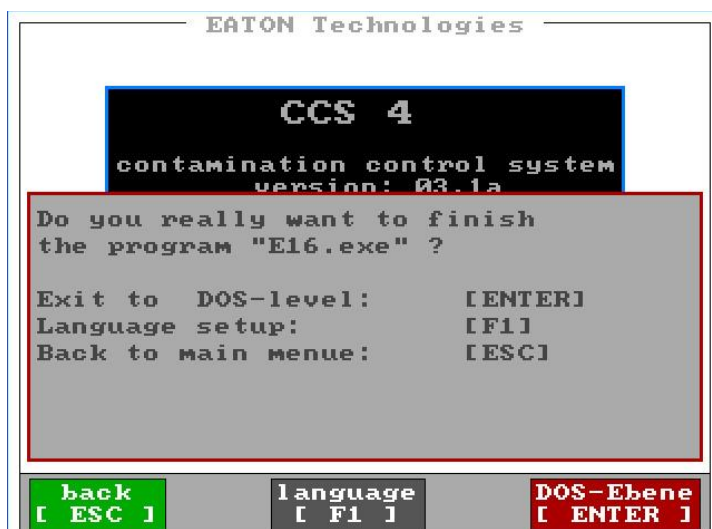

- Start the “filelink” program with [F1].
- Access the first site with [ENTER].
- Select **slave** and confirm.
- **Allow the system to overwrite the old data.**
- Connect the CCS 4 and the computer through the RS232 – interface cable.
- Start the computer in the DOS- mode.
- Copy the new CCS 4 - program into the same path where the **filelink.exe** is saved.
- Start **filelink.exe** at the computer.
- Confirm the first site with [ENTER].
- Select the main menu and confirm.
- Check the current settings. The correct serial access is necessary (COM1 or COM2) and the baud rate must be adjusted at 115200. If necessary correct the settings. Go back to the previous monitor.
- Confirm the **Master Mode**.
- Select the new program for the CCS 4 on the left side (on computer) and mark the according files with [SPACE] or mouse click (left mouse key).
- Copy the files to the CCS 4 with [ALT] + [C].
- Wait until all files are copied.
- If all files are copied, leave the “filelink” program at the computer and switch off the CCS 4 with the main switch.
- You can restart the CCS 4 regularly with the main switch (**ON**) now.

### 3. Evaluation of measurement results

#### 3.1. Water sensor

##### 3.1.1. Display in % water saturation

- If no kind of fluid was selected, only the water saturation in % is being displayed.

The screenshot shows a measurement display with the following data:

number of particles:					
>4µm	>6µm	>10µm	>14µm	>21µm	>38µm
1000000	100000	10000	1000	100	100
Reinheitsklassen:			24	20	14
water saturation: 48% at 51°C / 124°F					
test fluid: * / no selected fluid			cal. ppm: *		
date of start: 13. 02. 2013 07:06		measurement no.:		3 voltage: 37.20	
quit [ ESC ]	print [ F2 ]	continue [ F1 ]	new start [ ENTER ]		

##### (0...70% Saturation)

The presence of free water is unlikely. A danger of dissolved water in oil does **not** exist!

##### (70...90% Saturation)

The presence of free water is **likely** in a low volume. The initiation of actions to reduce the water content can be recommended!

##### (90...100% Saturation)

There is water in free form and is therefore a potential danger for the hydraulic and lubricating system.

**The initiation of actions to reduce the water content in the fluid is urgently necessary!**

A **conversion** in **mg/kg** (ppm) – water content is only **possible** when a **fluid generated saturation characteristic line is specifically made for your type of fluid**.

Saturation characteristic lines for special oils can be provided on request.

##### 3.1.2. Display of the fluid type and ppm water content

- If a fluid type is selected, the ppm water content **for this fluid is automatically** calculated from the deposited saturation function and is displayed.

The screenshot shows a measurement display with the following data:

number of particles:					
>4µm	>6µm	>10µm	>14µm	>21µm	>38µm
290000	29000	2900	290	29	29
Reinheitsklassen:			24	20	14
water saturation: 48% at 51°C / 124°F					
test fluid: HLP 22 / Tellus 22			cal. ppm: 229		
date of start: 08. 02. 2013 08:26		measurement no.:		1 voltage: 37.20	
break [ ESC ]	print [ F2 ]	continue [ F1 ]	new start [ ENTER ]		

The relation to the detected saturation values and the data, after Karl Fischer method accounted ppm (mg/kg), is calculated then evaluated by the detected and deposited 100% saturation curve (100% saturation = f(T)) and the simultaneously measured fluid temperature and is indicated at the display.

**Attention:** It is essential to select the correct kind of oil, or the display of the water content will not be equivalent with the effective value for this fluid.

Saturation characteristic curves for special oils can be created and implemented by Eaton Technologies GmbH. (Add-on program)

Example of a provided saturation characteristic curve:

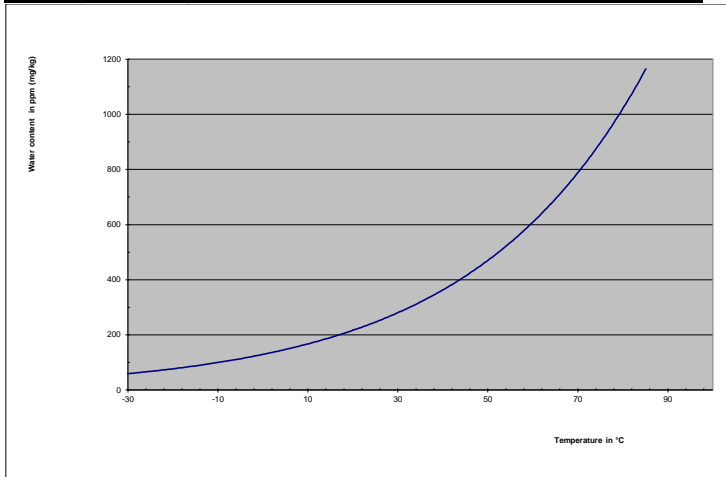

## 4. Calibration

- The laser sensor is calibrated according to ISO 11171 with ISO MTD – fluid and is delivered with a calibration certificate.
- The water sensor is calibrated on delivery as well.
- **NOTICE** The validity of the calibration certificate is 12 months.
- **CAUTION**  Eaton recommends a calibration interval of one year. For the secondary calibration the CCS 4, the unit is to be sent to Eaton Technologies GmbH in Altlußheim.
- The calibration and maintenance package for the CCS 4 contains the following benefits:
  - maintenance of the device,
  - control of consumption items,
  - a function test of the sensors,
  - calibration with a calibration certificate,
  - 24 hour functioning test.

## 5. Appendix

### 5.1. Technical data

<b>Measuring principle laser sensor:</b>	particle counting to the light barrier principle
<b>Measuring range laser sensor:</b>	for particle sizes of: 4...450 µm
<b>Particle counting according to:</b>	ISO 4406:99, ISO 4406:87, NAS 1638, SAE AS 4059
<b>Particle sizes:</b>	> 4 µm <sub>(c)</sub> , > 4,6 µm <sub>(c)</sub> , > 6,0 µm <sub>(c)</sub> , > 6,4 µm <sub>(c)</sub> , > 10 µm <sub>(c)</sub> , >14 µm <sub>(c)</sub> , > 21 µm <sub>(c)</sub> , > 37 µm <sub>(c)</sub> .
<b>Representation of cc:</b>	ISO 4 – 24, NAS 00 – 12, SAE AS 000 – 12
<b>Measuring accuracy:</b>	± 1 (contamination class)
<b>Calibration laser sensor:</b>	ISO MTD in oil (ISO 11171:2000)
<b>Max. particle concentration:</b>	24000 particle / ml (sensor)
<b>Sensor flowrate:</b>	50 ml / min
<b>Measuring principle water sensor:</b>	determination of the water saturation based on the change of capacitance
<b>Measuring range water sensor:</b>	saturation: 0 – 100 % temperature: -30...+ 70 °C / -22 ...+ 158 °F
<b>Suction operating range:</b>	-0,2...0,2 bar / -2.9...2.9 PSI
<b>Pressure operating range:</b>	1,5...420 bar / 22...6,000 PSI
<b>Viscosity range:</b>	10...400 mm <sup>2</sup> /s / 45...1854 SUS
<b>Operating temperature range:</b>	0...70°C / 32...158 °F
<b>Ambient temperature range:</b>	0...50°C / 32...122 °F
<b>Internal temperature range:</b>	0...45°C / 32...113 °F
<b>Fluid connections:</b>	1 x mini measuring screwed joint M 16x2, 2 x plug-in coupling for hose DN 6
<b>Fluid compatibility:</b>	hydraulic and lubricating fluids based on mineral oil (also see on separate list of compatibility (5.5))
<b>Power supply:</b>	15 V DC
<b>External power supply unit:</b>	100...240 V AC/ + 15 V DC/ 3,5 A, 50-60 Hz
<b>Internal rechargeable battery:</b>	15 V (Automatic with main connection)
<b>Fuses:</b>	T 5A
<b>Protection class:</b>	IP 67 (with closed cover)
<b>Measuring type:</b>	on-line: single, continuous, cyclic tank samples with internal pump off-line options with the BSS 2 (Bottle Sampling System)
<b>Cycle interval:</b>	up to 0,5...24 h, adjustable
<b>Display - output:</b>	contamination classes, number of particle, saturation, temperature, diagrams, graphics
<b>Printer - output:</b>	contamination classes, number of particle, saturation, temperature, graphics
<b>Storage capacity:</b>	4 x 100 measurements (100 per kind of measuring type)
<b>Further serial equipment:</b>	external power supply unit, high pressure hose, PVC – discharge hose, PVC – suction hose, data manager (CD- ROM with software)
<b>Display:</b>	5,6" LCD-colour display



**Interfaces:**

RS 232 (for external computer coupling)  
USB (data transfer of the TXT – files with the USB-stick)

**Dimensions (mm):**

l	x	b	x	h
425	x	284	x	155

**Weight:**

11,5 kg

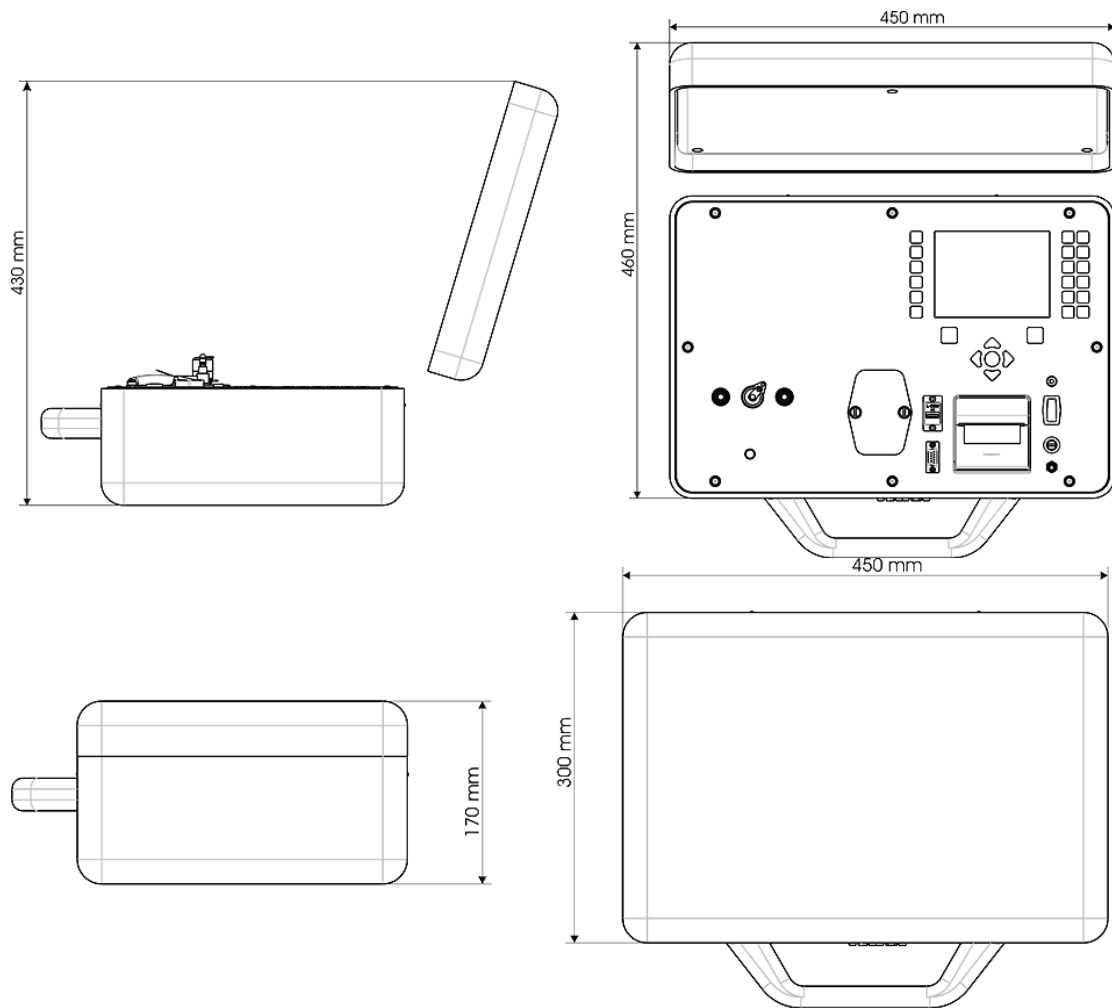

## 5.2. Hydraulic plan

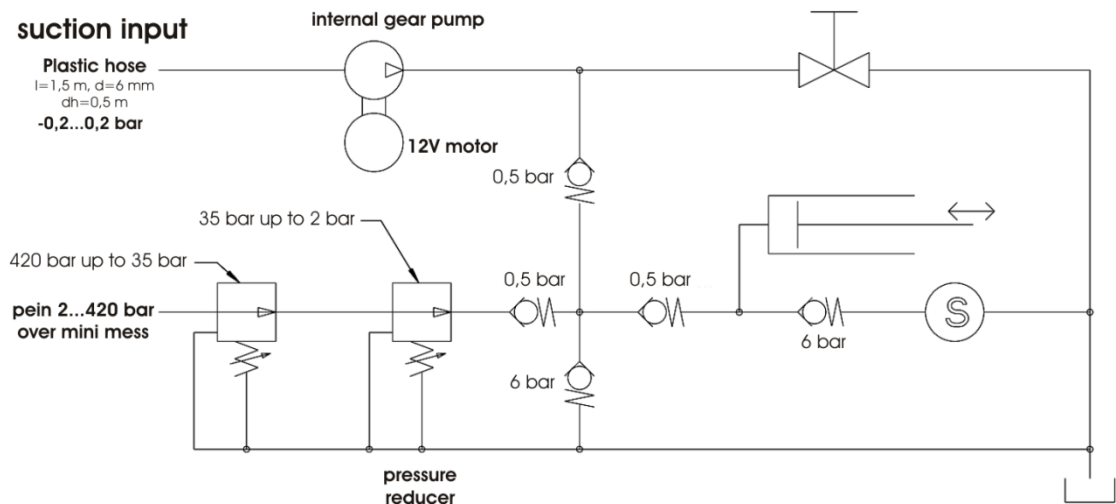

## 5.3. Measurement principle

### 5.3.1. Laser sensor – PFS 01

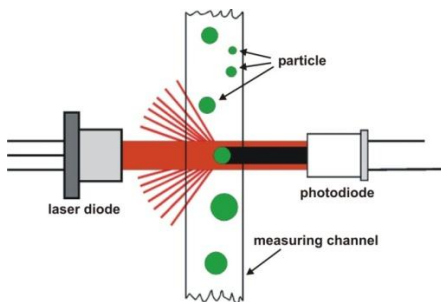

The laser sensor operates based on the light-blockade principle and generates an output signal depending on the particles' sizes. This is received, processed and classified by corresponding electronics.

The monochromatic light emitted by the laser diode is being received by a photo diode and then converted into an electric voltage. If a particle blocks this „light-blockade“, the photodiode will detect a decrease in received light depending on the particle's size and the electric voltage of the photodiode will decrease as well.

#### Troubles or faulty measurements by:

- Dark fluids
  - o The laser light cannot permeate the fluid column of the section measurements.  
⇒ no decrease of the light ⇒ it is not possible to detect the particles.
- Contamination too high
  - o Numbers of particles > 24000 P/ ml.
  - o High chance of measuring from multiple less particles as one great particle.
- Conglomeration of fewer particles to one great particle through static electrical attractive forces or additives ⇒ faulty measurement and the sensor is blocked!
  - o It is not applicable during the off-line measurement by processing of the oil sample in the ultrasonic bath and sufficient homogenization (shaking) of the fluid before the measurement.
- Free water and air bubbles
  - o Falsification of the measurement results.
  - o Description of the water particle and air bubbles as great particles.



- The measuring of HFA, HFB, HFC and aqueous cooling emulsion is not possible.
- Automatic flushing processes in all programs shall prevent false measurements. Therefore the CCS 4 gets flushed completely with the new oil before the next measurement is done.
  - Single measurements:
    - Automatic flushing before the first measurement.
    - Automatic flushing before following measurements, when more than 10 minutes are gone since the last measurement or when changing the measuring point.
  - Continuous measurements:
    - Automatic flushing when starting the measurement.
  - Cyclic measurement:
    - Automatic flushing before each measurement.
  - Off-line measurement:
    - Manual start of flushing process.
- The measuring and display of the temperature, the water saturation and the water content of the fluid in all measuring programs should be prevent from alterations of the measurement results.

### 5.3.1.1. 8 – channel particle counting

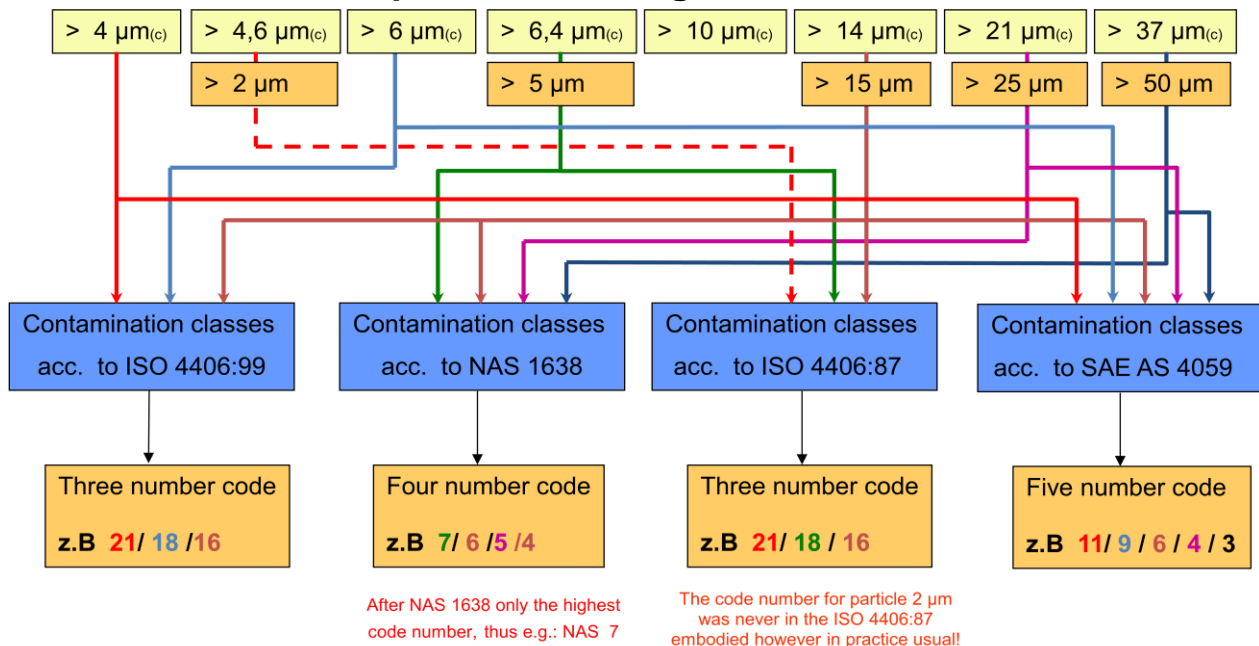

### 5.3.2. Water sensor

The **water sensor** is a **capacitive sensor**. As a dielectric between two electrodes a polymer film is used, which is able to absorb water molecules and by doing so it changes the capacity of the sensor element. This capacity is changed in a sensor output signal of **4... 20 mA**. As a measurement output the **saturation condition** (water saturation) of the fluid is displayed in **percent**.

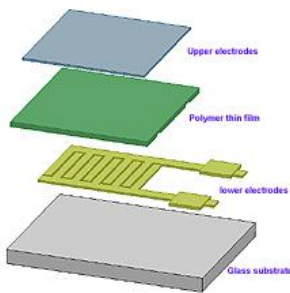

In addition, a temperature sensor is installed for precise temperature measurement of the fluid during the measurement.

As opposed to the absolute water content determination by the **Karl Fischer method**, in which the total mass fraction of free water and bound **water in mg / kg of oil** is stated, the **water sensor** evaluates the saturation condition of the fluid with water in percent.

The specification **100%** stands for a complete saturation of the fluid.

The saturation values are temperature dependent!

A relation to the detected saturation values and the data, after the Karl Fischer method accounted ppm (mg/kg), is calculated by the detected and deposited 100% saturation curve (100% saturation = f(T)) and the simultaneously measured fluid temperature, and is indicated at the display.

#### 5.4. Overview of the data storage and measurement results

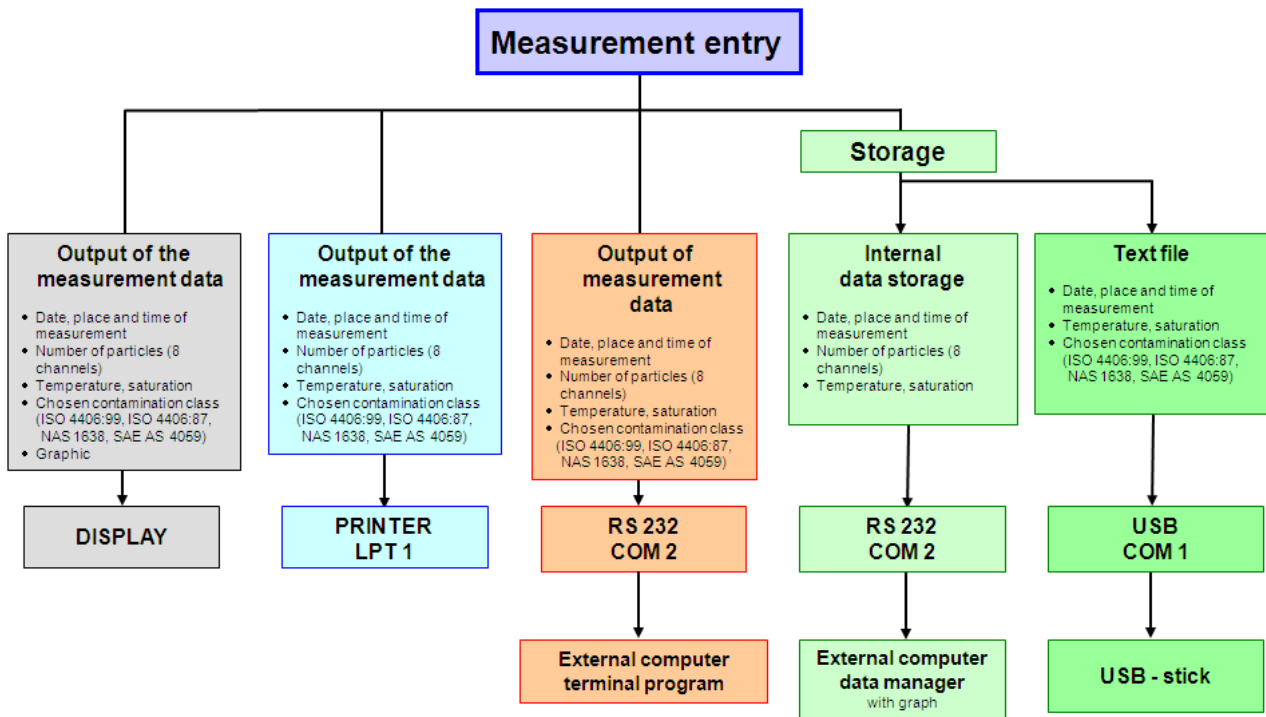

## 5.5. Cleanliness classes according to ISO 4406:99

According to ISO 4406 (year 1999) the number of particles sized  $> 4 \mu\text{m}_{(c)}$ ,  $> 6 \mu\text{m}_{(c)}$  and  $> 14 \mu\text{m}_{(c)}$  is being used to determine the cleanliness class. The determination of the cleanliness class doesn't depend on the particle size.

Example of presenting:

**20 / 16 / 12**

Partikel  $> 14 \mu\text{m}_{(c)}$

Partikel  $> 6 \mu\text{m}_{(c)}$

Partikel  $> 4 \mu\text{m}_{(c)}$

**Analysis volume: 1 ml**

Cleanliness class	Number of particles .....	Up to and including
<b>26</b>	320000	640000
<b>25</b>	160000	320000
<b>24</b>	80000	160000
<b>23</b>	40000	80000
<b>22</b>	20000	40000
<b>21</b>	10000	20000
<b>20</b>	5000	10000
<b>19</b>	2500	5000
<b>18</b>	1300	2500
<b>17</b>	640	1300
<b>16</b>	320	640
<b>15</b>	160	320
<b>14</b>	80	160
<b>13</b>	40	80
<b>12</b>	20	40
<b>11</b>	10	20
<b>10</b>	5	10
<b>9</b>	2,5	5
<b>8</b>	1,3	2,5
<b>7</b>	0,6	1,3
<b>6</b>	0,3	0,6

## 5.6. Cleanliness classes according to NAS 1638

**Analysis volume: 100 ml**

Particle number x 10<sup>3</sup>

Class	5 - 15 µm	15 - 25 µm	25 - 50 µm	50 - 100 µm	> 100 µm
00	0,125	0,022	0,004	0,001	0
0	0,250	0,044	0,008	0,002	0
1	0,5	0,089	0,016	0,003	0,001
2	1	0,178	0,032	0,006	0,001
3	2	0,356	0,063	0,011	0,002
4	4	0,712	0,126	0,022	0,004
5	8	1,425	0,253	0,045	0,008
6	16	2,85	0,506	0,090	0,016
7	32	5,7	1,012	0,18	0,032
8	64	11,40	2,025	0,36	0,064
9	128	22,8	4,05	0,72	0,128
10	256	45,6	8,1	1,44	0,256
11	512	91,2	16,2	2,88	0,512
12	1024	182,4	32,4	5,76	1,024

## 5.7. Cleanliness classes according to SAE AS 4059

Analysis volume: 100 ml

Size, ISO 11171 Calibration or Electron Microscope	Particle per 100 ml					
	> 4 $\mu\text{m}$ <sub>(c)</sub>	> 6 $\mu\text{m}$ <sub>(c)</sub>	> 14 $\mu\text{m}$ <sub>(c)</sub>	> 21 $\mu\text{m}$ <sub>(c)</sub>	> 38 $\mu\text{m}$ <sub>(c)</sub>	> 70 $\mu\text{m}$ <sub>(c)</sub>
Size Code	A	B	C	D	E	F
000	195	76	14	3	1	0
00	390	152	27	5	1	0
0	780	304	54	10	2	0
1	1560	609	109	20	4	1
2	3120	1220	217	39	7	1
3	6250	2430	432	76	13	2
4	12500	4860	864	152	26	4
5	25000	9730	1730	306	53	8
6	50000	19500	3460	612	106	16
7	100000	38900	6920	1220	212	32
8	200000	77900	13900	2450	424	64
9	400000	156000	27700	4900	848	128
10	800000	311000	55400	9800	1700	256
11	1600000	623000	111000	19600	3390	512
12	3200000	1250000	222000	39200	6780	1020

## 5.8. Fields of application – compatibility

**NOTICE** ⚠️ ⚡️

**Applicable for:**

- hydraulic oils H, HL, HLP, and HV
- gear oils C, CL, CLP
- motor oils, gas oils
- MIL-H-5606 E
- vegetable based oils (HTG, triglycerides)
- synthetic esters (HEES, HFD-U, HFD-R (**without Skydrol**))

## 5.9. Trouble shooting

No settings of the CCS 4 are done by the operator.

Malfunctions, which could be eliminated by the operator, are limited to checking cables for breaks. ⚡️

**NOTICE** Any other cases require sending the CCS 4 to Eaton Technologies GmbH in order to recover the functions.

A brief description of the problem would expedite the trouble shooting and the repair process. To check your warranty and to answer questions by phone we need the serial number and the date of purchase of the instrument.

## 5.10. Shipment, parts list



	<b>article no.:</b>
(1) CCS 4	337546
(2) Power supply unit, inclusive power cable	338658
(3) RS232 – interface cable	314462
(4) RS232 – adaptor plug to USB	336300
(5) High pressure hose	313742
(6) PVC – hose DR. 8x1	316875
(7) Quick connector Rectus 21K KO08 MPX	335908
(8) 4 rolls print-out paper	335920
(9) Data manager CD	337625
(10) Instruction manual	336298
(11) USB – stick	337627
(12) Calibration certificate	after annual maintenance/ calibration at Eaton Technologies GmbH

**North America — HQ**

70 Wood Ave., South, 2nd Floor  
Iselin, NJ 08830  
Toll Free: (800) 656-3344  
(North America Only)  
Voice: (732) 767-4200

**China**

No. 3, Lane 280, Linhong Road  
Changning District, 200335  
Shanghai, P.R. China  
Voice: +86-21-5200-0099

**Singapore**

4 Loyang Lane #04-01/02  
Singapore 508914  
Voice: +65-6825-1668

**Europe/Africa/Middle East**

Friedensstrasse 41  
D-68804 Altlussheim, Germany  
Voice: +49-6205-2094-0

Auf der Heide 2  
53947 Nettersheim, Germany  
Voice: +49-2486-809-0

An den Nahewiesen 24  
55450 Langenlonsheim, Germany  
Voice: +49 6704 204-0

**Brazil**

Av. Julia Gaioli, 474 –  
Bonsucesso  
07251-500 – Guarulhos, Brazil  
Voice: +55 (11) 2465-8822

*For more information, please e-mail us at  
[filtrationinfo@eaton.com](mailto:filtrationinfo@eaton.com)*

*Visit us online [eaton.com/filtration](http://eaton.com/filtration) for a complete  
list of Eaton's filtration products.*

©2012 Eaton Corporation. All Rights Reserved.  
All trademarks and registered trademarks are the property of their respective  
owners. Litho USA.

All information and recommendations appearing in this brochure concerning the  
use of products described herein are based on tests believed to be reliable.  
However, it is the user's responsibility to determine the suitability for his own use  
of such products. Since the actual use by others is beyond our control, no  
guarantee, expressed or implied, is made by Eaton as to the effects of such use or  
the results to be obtained. Eaton assumes no liability arising out of the use by  
others of such products. Nor is the information herein to be construed as  
absolutely complete, since additional information may be necessary or desirable  
when particular or exceptional conditions or circumstances exist or because of  
applicable laws or government regulations.



Powering Business Worldwide

