

ER09 / ER19 Series

Electronic Proportional Regulator

0 to 10 volt, 4 to 20 mA

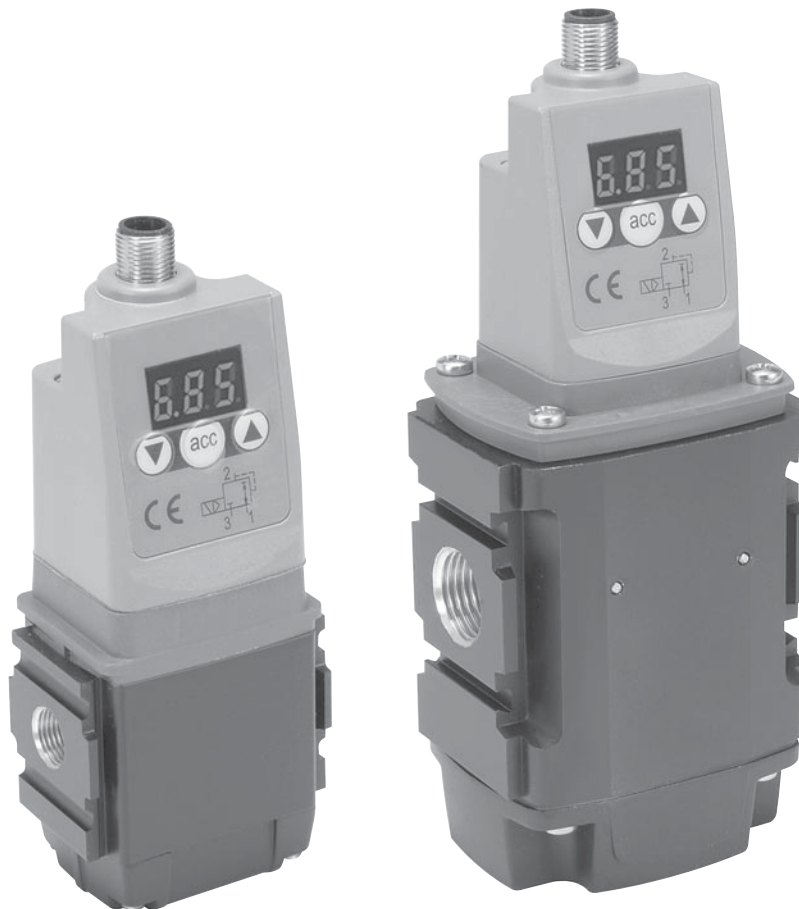

Proportional Regulator Applications.....	2-3
Why Proportional Technology?.....	4
Numbering System (Ordering Information)	5
Options	6
Technical Information.....	7-8

Programming Information.....	9-17
Dimensions.....	18
Troubleshooting	19
Glossary	20

Man-Machine Interface

High Visibility LED Display
 Easy to Read Characters
 All Controls on the Same Face

Total Flexibility

User Friendly and Easily Accessible Software Controls
 One Basic Unit Suits All Customer Requirements -
 0-10V Control Signal Standard
 4-20mA Control Signal Software Selectable
 Modular Mounting
 10 bar & 2 bar Version

Special Applications

Clean Line Design
 Suitable for Washdown: IP65
 Forced Exhaust Option Available
 4 Output Signal Versions Available

Compact and Light Weight

40 & 60 mm Body Sizes
 Light Weight Aluminum Bodies

Flexible Mounting Options

Stand-alone or Modular Mounting
 Foot Bracket Mounting
 DIN-Rail Mounting

Energy Saving

Low Watt Power Consumption
 No Unnecessary Loss of Air in Steady State

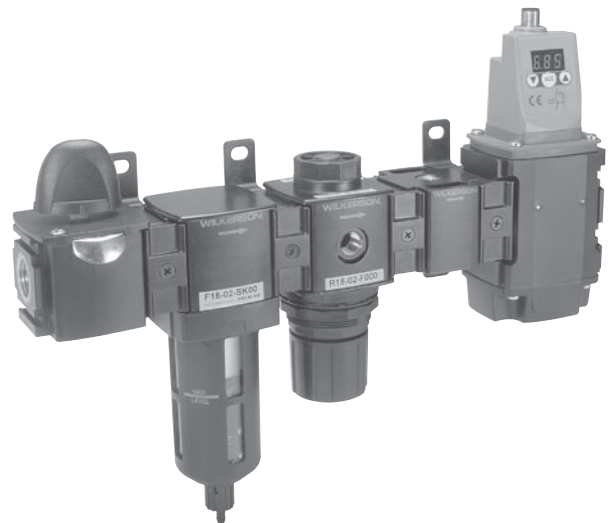

Outstanding Performance

Very Fast Response Times
 Full Flow Exhaust
 Excellent Linearity
 High Flow

Generic Industries



The new Proportional Regulator is designed to quickly and accurately adjust and maintain a set output pressure.

The unit will operate regardless of flow, in response to an electronic control signal. The media can be compressed air or an inert gas.

Applications for this technology are virtually unlimited; from paint spray control, paper manufacturing and printing to weaving and laser cutting control; in fact anywhere that requires accurate remote pressure control.

Automation

In the field of general automation, the need to control processes or movement via electronic signals is of paramount importance. The Proportional Regulator unit provides the facility to incorporate pressure control into a fully integrated control system.



Packaging and Food



The Packaging and Food industry provides another ideal area for application of the Electronic Proportional Regulator, where fine control of tension on wrapping foils and paper is required. The degree of control and the ability to manually change parameters makes this unit ideally suited to the varying requirements of this industry.

Automotive

Applications for this innovative product in the Automotive industry can be seen in major manufacturers' "body-in-white" lines.

The control of clamping and welding forces during panel assembly is an ideal application, also accurate control in paint dipping and spraying can be achieved.

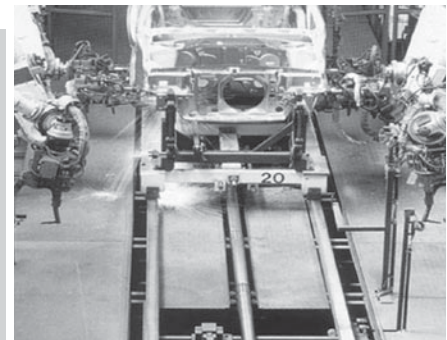

Why Proportional Technology ?

The Difference Between Open or Closed Circuit Control

Standard pressure regulators go a long way towards meeting customers needs. In most cases these regulators work well in general pneumatic and automation applications. However, sometimes the application calls for more precise pressure control. The effects of time, cycling, input, back pressure or pressure and flow variation can all cause inconsistencies in pneumatic systems. Proportional Regulators are designed to eliminate those inconsistencies.

Open Control Circuit

In a normal pressure regulated control system, the inlet pressure (p_1) is converted into the output pressure (p_2) by the regulator. The set pressure (set value) is usually manually set by adjusting the control knob and in normal circumstances the regulator maintains the output pressure (actual value).

No facility for monitoring the output pressure is provided and there is consequently no way of checking that the set value and the actual value are the same. Also, no account is taken of external influences such as air consumption by the system, which can drastically alter the actual value.

Closed Loop Control Circuit

The input signal (Electronic Control Signal) is converted into the output value (P2 Output Pressure). This output value is continuously measured and compared with the input signal. If they are different, the unit adjusts the output value to correspond to the set value, to close the loop.

Proportional Pressure Regulators

The Proportional Regulators provide all the advantages of a closed circuit regulated system. When a set value is defined via the input signal (e.g. 0-10 V), the pressure regulator sets the corresponding output pressure (e.g. 0-150 PSI/0-10 bar). At the same time the integrated pressure sensor measures the actual pressure at the unit's outlet (actual value).

If the electronic regulation system finds that the actual value has deviated from the set value, it immediately corrects the actual value. This is a continuous process ensuring fast, accurate pressure regulation.

Typical Application in Automotive Body in White Welding Pressure Control

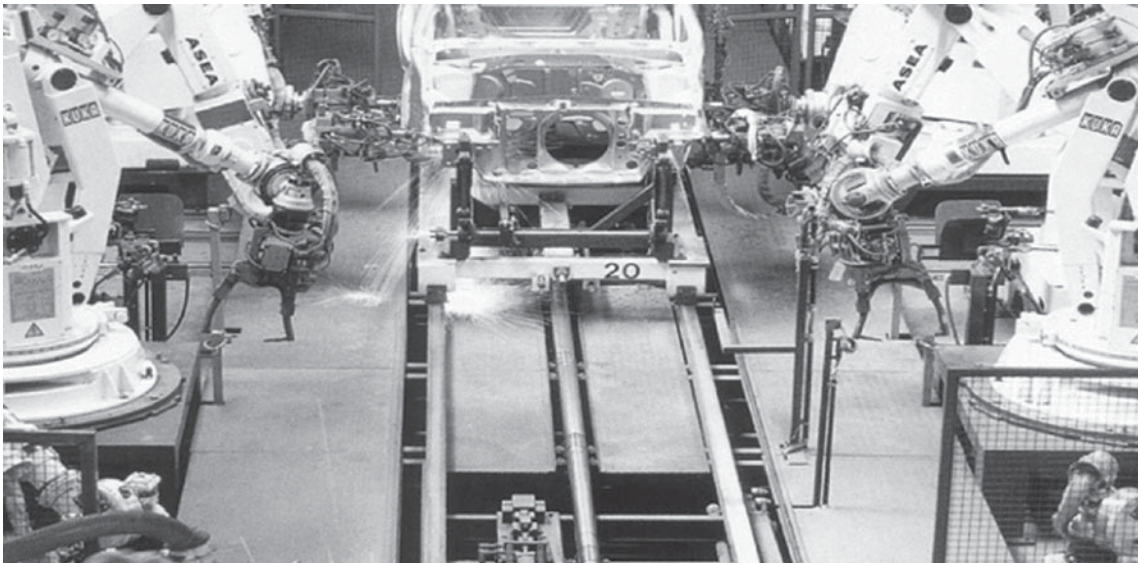

Electronic Proportional Regulator Numbering System

= "Most Popular"

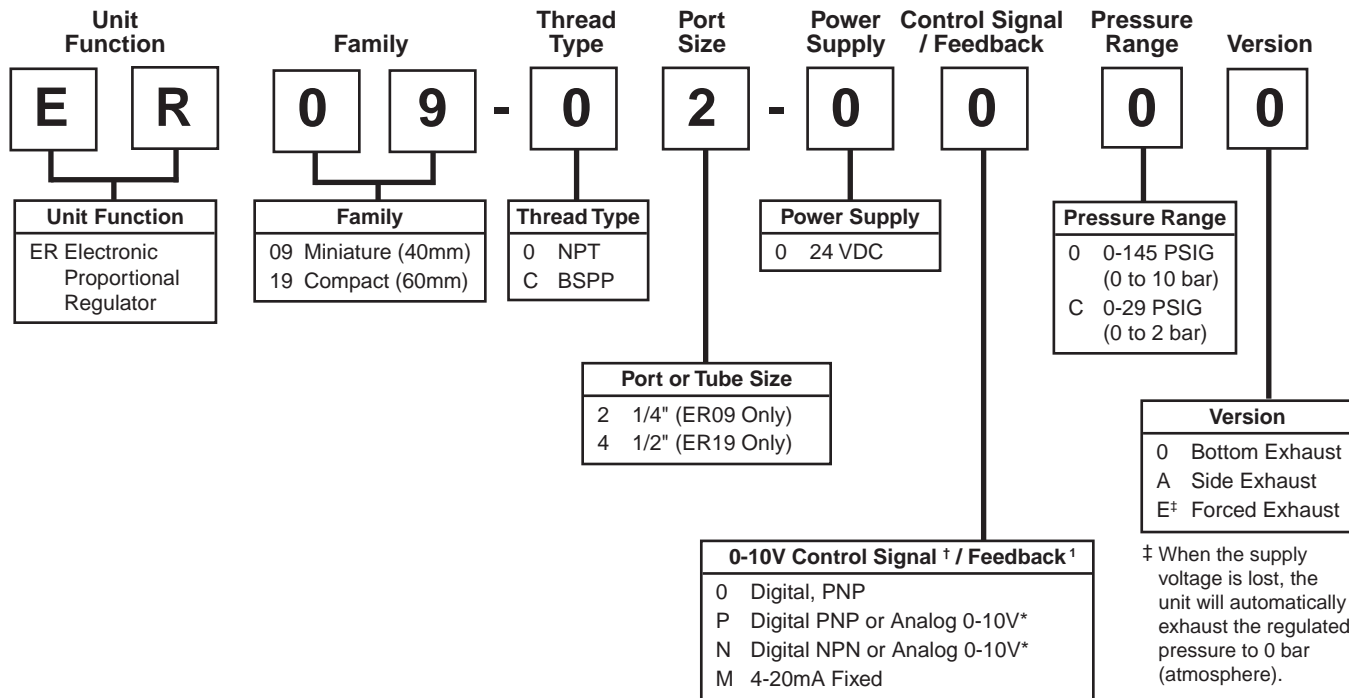

‡ When the supply voltage is lost, the unit will automatically exhaust the regulated pressure to 0 bar (atmosphere).

† All products have a 0-10V control signal, this is switchable to 4-20mA by means of parameter 4.

* Selectable by means of Parameter 6

- 1 0) Digital PNP output only, no analog output selectable
- P) Digital PNP and analog 0-10V outputs selectable by means of parameter 6 (factory defaults 0-10V)
- N) Digital NPN and analog 0-10V outputs selectable by means of parameter 6 (factory defaults 0-10V)
- M) Analog 4-20mA output only

ER09 / ER19 Kits

- Seal Kit (Valve Seat, Cover Seal)3538200
- Valve Kit (2 Valves, Screws, Cover Seal) 3538100
- Cable (M12, 4-Pin Female Connection
with 2m Cable)..... CB-M12-4P-2M

Ordering Code

Port Size	Order Code	Control Signal	Output Signal	Output Pressure
1/4	ER09-02-00C0	0 - 10 V	Digital PNP Only	0-29 PSIG (0 -2 bar)
1/4	ER09-02-0000	0 - 10 V	Digital PNP Only	0-145 PSIG (0 -10 bar)
1/4	ER09-02-0PC0	0 - 10 V	Digital PNP or 0-10V	0-29 PSIG (0 -2 bar)
1/4	ER09-02-0P00	0 - 10 V	Digital PNP or 0-10V	0-145 PSIG (0 -10 bar)
1/4	ER09-02-0NC0	0 - 10 V	Digital NPN or 0-10V	0-29 PSIG (0 -2 bar)
1/4	ER09-02-0N00	0 - 10 V	Digital NPN or 0-10V	0-145 PSIG (0 -10 bar)
1/4	ER09-02-0MC0	0 - 10 V	4-20mA Analog Only	0-29 PSIG (0 -2 bar)
1/4	ER09-02-0M00	0 - 10 V	4-20mA Analog Only	0-145 PSIG (0 -10 bar)
1/2	ER19-04-00C0	0 - 10 V	Digital PNP Only	0-29 PSIG (0 -2 bar)
1/2	ER19-04-0000	0 - 10 V	Digital PNP Only	0-145 PSIG (0 -10 bar)
1/2	ER19-04-0PC0	0 - 10 V	Digital PNP or 0-10V	0-29 PSIG (0 -2 bar)
1/2	ER19-04-0P00	0 - 10 V	Digital PNP or 0-10V	0-145 PSIG (0 -10 bar)
1/2	ER19-04-0NC0	0 - 10 V	Digital NPN or 0-10V	0-29 PSIG (0 -2 bar)
1/2	ER19-04-0N00	0 - 10 V	Digital NPN or 0-10V	0-145 PSIG (0 -10 bar)
1/2	ER19-04-0MC0	0 - 10 V	4-20mA Analog Only	0-29 PSIG (0 -2 bar)
1/2	ER19-04-0M00	0 - 10 V	4-20mA Analog Only	0-145 PSIG (0 -10 bar)

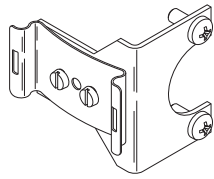

DIN Rail

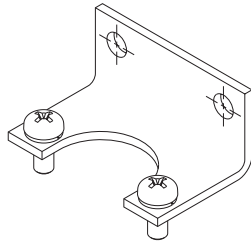

Foot Bracket

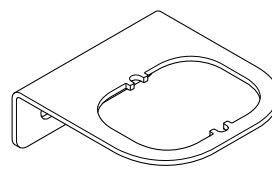

L-Bracket

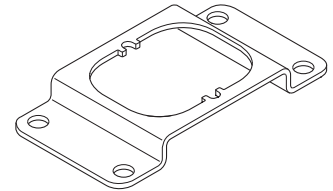

Foot Bracket

ER09 Mounting Brackets

Order Code	Description
P3HKA00MK	DIN Rail Mounting Kit
P3HKA00MF	Foot Bracket Mounting Kit

ER19 Mounting Brackets

Order Code	Description
P3KKA00ML	L-Bracket Mounting Kit
P3KKA00MC	Foot Bracket Mounting Kit

Pneumatics

Working Media

Compressed air or inert gasses, filtered to 40µ.

Operating Pressure

Max. Operating Pressure
 2 bar unit.....3 bar (43.5 PSI)
 10 bar unit10.5 bar (152 PSI)
 Min. Operating Pressure P2 Pressure + 0.5 bar
 (7.3 PSI)

Pressure Control Range

Available in two pressure ranges, 0-2 bar (0-29 PSI) or 0-10 bar (0-145 PSI). Pressure range can be changed through the software at all times. (parameter 19)

Temperature Range

32°F to 122°F (0°C to 50°C)

Weight

ER09 0.64 lbs (.291 kg)
 ER19 1.42 lbs (.645 kg)

Air Consumption

No consumption in stable regulated situation.

Display

The regulator is provided with a digital display, indicating the output pressure, either in PSI or bar.

The factory setting is as indicated on the label, can be changed through the software at all times (parameter 14).

Electronics

Supply Voltage

24 VDC +/- 10%

Power Consumption

1.1 W with unloaded signal outputs

Current Consumption

Max. 200 mA with no load

Control Signals

The electronic pressure regulator can be externally controlled through an analog control signal of 0-10 V, adjustable to 4-20 mA via parameter 4.

Connections

Central M12 male connector 4-pole.

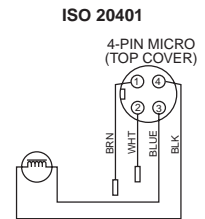

The electrical connections are as follows:

Pin No.	Function	Color	
1	24 V	Supply	Brown
2	0 to 10 V or 4 to 20mA Ri = 100k Ω	Control Signal	White
3	0 V (GND)	Supply	Blue
4	24 V	Alarm Output Signal	Black

In the case of 4 to 20mA the Ri will be 500 Ohm

Schematic

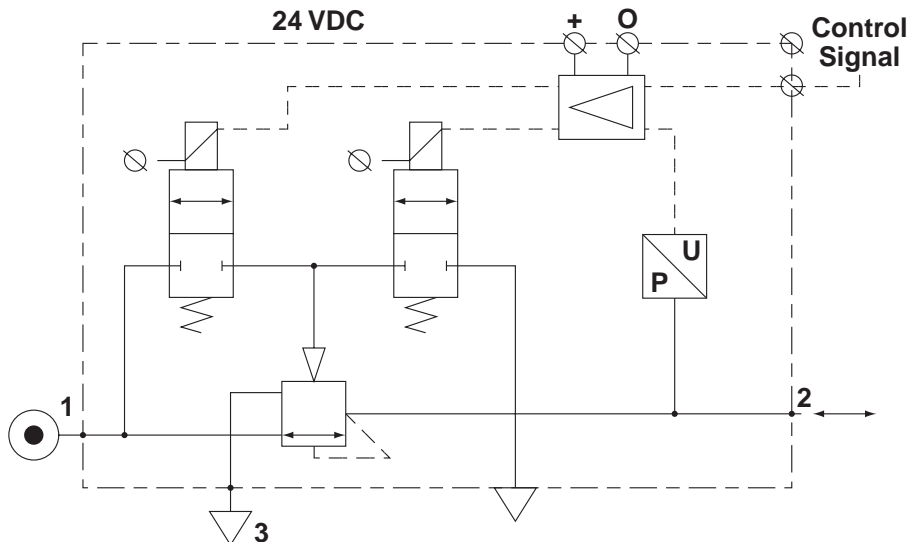

Technical Information

Dead Band

The dead band is preset at 1.3% of Full Scale*, adjustable via parameter 13.

Accuracy

Linearity: = < 0.3% of Full Scale.*

Proportional Band

The proportional band is preset at 10% of Full Scale.*

Fail Safe Operation

- If the ER09 / ER19 unit has an “0” or “A” in the 12th digit of the model number
 - o When the supply voltage drops, the electronic control reverts to the fail safe mode. The last known output pressure is maintained at approximately the same level depending upon air consumption. The digital display indicates the last known pressure setting.
 - o When the supply voltage is reinstated to the correct level, the valve moves from the fail safe mode and the output pressure immediately follows the control signal requirement. The display indicates the actual output pressure.
 - o Note: In the event of loss of both power and inlet pressure the unit will exhaust downstream pressure.
- If the ER09 / ER19 unit has an “E” in the 12th digit of the model number
 - o When the supply voltage drops, the electronic control reverts to “Forced Exhaust Mode” and will automatically exhaust the downstream (regulated) pressure.
 - o When the supply voltage is reinstated to the correct level the unit will return to normal operation and follows the control signal requirement. The display indicates the actual pressure.
- If the unit has been programmed in manual mode (not with a control signal) the unit will EXHAUST and the regulator will need to be reset when power is applied.

Full Exhaust

Complete exhaust of the regulator is defined as $P_2 \leq 1\%$ Full Scale

* Full Scale (F.S.)

For 2 bar versions this will be 2 bar, for the 10 bar version full scale will be 10 bar.

Degree of Protection

IP65

EU Conformity

CE: standard

EMC: according to directive 89/336/EEC

The new pressure regulator is in accordance with:

EN 61000-6-1:2001
EN 61000-6-2:2001
EN 61000-6-3:2001
EN 61000-6-4:2001

These standards ensure that this unit meets the highest level of EMC protection.

Mounting Position

Preferably vertical, with the cable gland on top.

Materials

Magnet Core	Steel
Solenoid Valve Poppet	FPM
Solenoid Valve Housing	Techno Polymer
Regulator Body (ER09 / ER19)	Aluminum
Regulator Top Housing	Nylon
Valve Head	Brass & NBR
Remaining Seals	NBR

Advanced Functionality

Pilot Valve Protection

When the required output pressure can not be achieved due to lack of input pressure, the unit will open fully and will display "NoP". Approximately every 10 seconds the unit will retry. The output pressure will then be approximately equal to the inlet pressure. As soon as the input pressure is back on the required level, the normal control function follows.

Safety Exhaust

Should the **control signal** fall below 0.1 volts, the valve will automatically dump downstream system pressure.

Input Protection

The unit has built-in protection against failure and burnout resulting from incorrect input value, typically:

The 24v DC supply is incorrectly connected to the setpoint input, the display will show 'OL', as an overload indication. The unit will need to be rewired and when correctly connected will operate normally.

The overload indicator 'OL' will also appear should the wrong input value be applied or the wrong input value be programmed: 4 - 20m instead of 0 - 10V. To correct this a different set point value should be input or the unit reprogrammed to correct the set point value acceptance. (via parameter 4).

Response Times

Response time	ER09	ER19
2 to 4 bar	25 msecs	35 msecs
1 to 6 bar	55 msecs	135 msecs
4 to 2 bar	70 msecs	85 msecs
6 to 1 bar	80 msecs	225 msecs

To fill volume of:

100cm³ - ER09

330cm³ - ER19

connected to the outlet of the regulator.

Settings

The regulator is pre-set at the factory. If required, adjustments can be made.

Flow Characteristics

ER09 Regulator 1/4" Ports

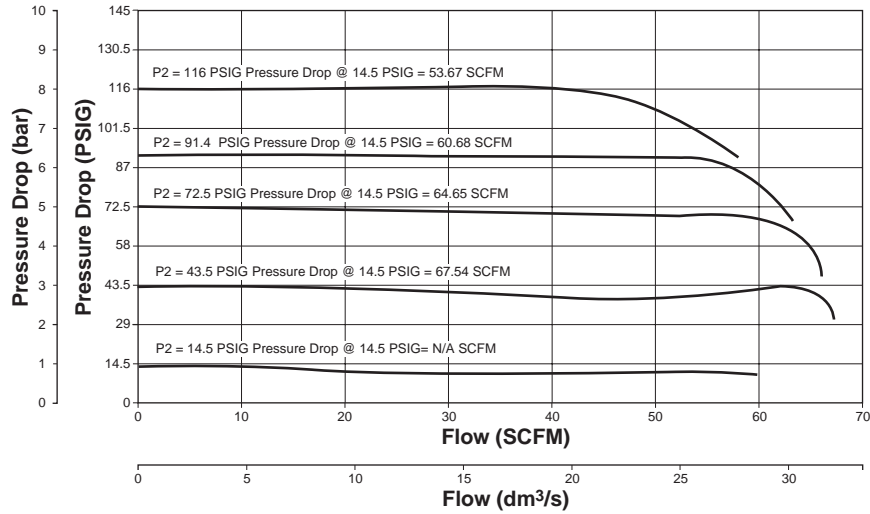

ER19 Regulator 1/2" Ports

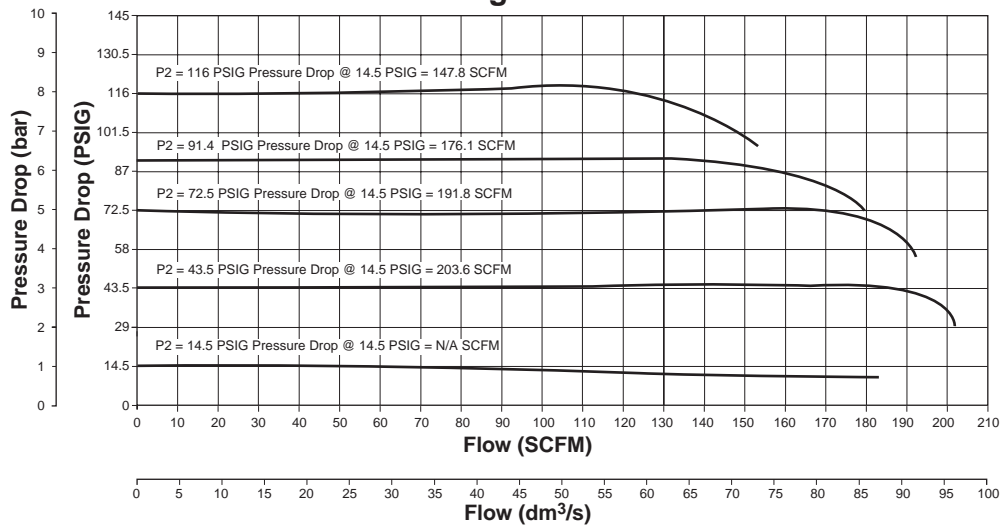

How to change parameters

Pressing the Accept key “acc” for more than 3 seconds, will activate parameter change mode. The user can then select the parameters by pressing up or down key. (display will show Pxx). When parameter number is correct, pressing accept again will enter parameter number.(display will show parameter value).

Pressing the up or down key will change the parameter itself. (display will flash indicating parameter editing mode). Pressing the accept key will accept the new parameter value. (all digits will flash whilst being accepted).

After releasing all keys , the next parameter number will be presented on the display. (you may step to the next parameter). When no key is pressed, after 3 seconds the display will show the actual output pressure.

When the unit is initially powered up allow approximately 10 seconds for the unit to “boot-up” before changing parameter settings.

Only parameter numbers 0, 4, 6, 8, 9, 14, 18, 19, 20, 12, 13 and 21 are accessible to edit. All other parameters are fixed.

Manual mode

When keys DOWN and UP are pressed during startup, (connecting to the 24V power supply) manual mode is activated. This means that the user is able to in/decrease the output pressure of the regulator, by pressing the UP or DOWN key. During this action the display will blink, indicating that the manual mode is activated. After powering up again, the unit will revert back to normal mode.











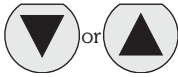

Back to Factory Setting

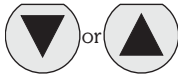
After start up. (Power is on)

Parameter 0 = 3

Entering this value in parameter 0 will store the calibrated factory data into the working parameters. (Default calibration data is used)











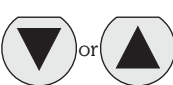

Parameter Number 0 – Reset Back to Factory Settings

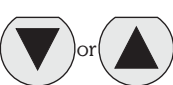
Step	1	2	3	4	5	
Press 	 3-6 seconds					
Until Display Reads			 Flashing Decimal	 Flashing Decimal	 Flashing	
Description	Accesses changeable parameters.	Accesses parameter no. 0.	Displays current parameter value.	Edits parameter. 3 = standard factory settings. If other than 3, use Up or Down Arrow and accept 3	Accepts and saves new parameter setting.	Sequences to next parameter.

Set Control Signal

The unit is factory set for 0-10 V control signal. If 4-20 mA control signal is required, change parameter 4.

Parameter Number 4 – Set Control Signal in Volts or Milliamps

Step	1	2	3	4	5	
Press 	 3-6 seconds					
Until Display Reads			 Flashing Decimal	 Flashing Decimal	 Flashing	
Description	Accesses changeable parameters.	Accesses parameter no. 4.	Displays current parameter value. 1 = V 0 = mA	Edits parameter.	Accepts and saves new parameter setting.	Sequences to next parameter.

Set Output Signal

Parameter 6 is used to set the type of out put signal to your PLC. This parameter is used as follows:

Output Signal option “0” = Digital Output – PNP

- Factory set at “0” Non Adjustable

Output Signal option “P” = Digital PNP or Analog 1-10V

- Factory set at “1” for Analog Signal
- Convert to Digital PNP by changing parameter to “0” setting











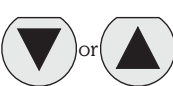

Output Signal option “N” = Digital NPN or Analog 1-10V

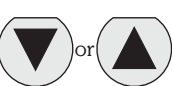
- Factory set at “1” for Analog Signal
- Convert to Digital NPN by changing parameter to “0”

Output Signal option “M” = Analog 4-20 mA

- Factory Set at “2” Non Adjustable

Parameter Number 6 – Set Output Signal











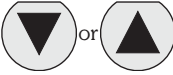

Step	1	2	3	4	5	
Press 	 3-6 seconds					
Until Display Reads			 Flashing Decimal	 Flashing Decimal (Value 0, 1 or 2)	 Flashing	
Description	Accesses changeable parameters.	Accesses parameter no. 6.	Displays current parameter value. 1 = m factory default for ER with analog options	Edits parameter. 0 = digital (NPN or PNP) 1 = analog 0..10V 2 = analog 4..20 mA	Accepts and saves new parameter setting.	Sequences to next parameter.

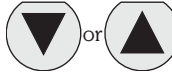
Adjust Span Analog Output Signal

Parameter 8 is used to adjust the Analog output range.

- Set value is a % of Full Analog range. As an example for a 0-10V output signal the original factory setting of 100% will give you an adjustment of 0-10V. If you reset Parameter 8 to 50% the new output range would be 0-5 V or 50% of the full range.
- In the event that the output signal is to low, in a certain application, you can adjust it by increasing Parameter 8 to a maximum value of 130% of scale.
- Note that all values are nominal and that an actual measurement may be required to ensure signal strength.













Parameter Number 8 – Adjust Span Analog Output Signal

Step	1	2	3	4	5	
Press 	 3-6 seconds					
Until Display Reads			 Flashing Decimal	 Flashing Decimal (Value between 0 and 130)	 Flashing	
Description	Accesses changeable parameters.	Accesses parameter no. 8.	Displays current parameter value.	Edits parameter.	Accepts and saves new parameter setting and implements the new analog signal span.	Sequences to next parameter.

Adjust Digital Display

If necessary, adjustments can be made to the digital display when using an external pressure sensor.











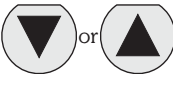

Parameter Number 9 – Adjust Digital Display Value (Pressure Calibration)

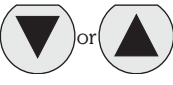
Step	1	2	3	4	5	
Press 	 3-6 seconds					
Until Display Reads			 Flashing Decimal	 Flashing Decimal	 Flashing	
Description	Accesses changeable parameters.	Accesses parameter no. 9.	Displays current digital display	Use up or down arrows and accept to adjust the display value if using an external pressure sensor.	Accepts and saves new parameter setting.	Sequences to next parameter.

Set Pressure Scale

Units with NPT port threads are supplied with a factory set PSI pressure scale. Use parameter 14 to change scale to bar.











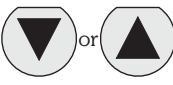

Parameter Number 14 – Set Pressure Scale in PSI or bar

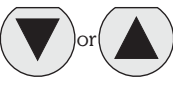
Step	1	2	3	4	5	
Press 	 3-6 seconds					
Until Display Reads			 Flashing Decimal	 Flashing Decimal	 Flashing	
Description	Accesses changeable parameters.	Accesses parameter no. 14.	Displays current parameter value. 1 = PSI 0 = bar 2 = MPA	Edits parameter.	Accepts and saves new parameter setting.	Sequences to next parameter.

Preset Minimum Pressure

If there is a need for a pre-set minimum pressure, use parameter 18. (Note: preset pressure is affected by % P19.)

Parameter Number 18 – Set Minimum Preset Pressure

Step	1	2	3	4	5	
Press 	 3-6 seconds					
Until Display Reads			 Flashing Decimal	 Flashing Decimal (value between 0 and 200)	 Flashing	
Description	Accesses changeable parameters.	Accesses parameter no. 18.	Displays current parameter value. Incremental value is: <u>2 bar unit:</u> x 2 mbar x % P19 <u>10 bar unit:</u> x 10 mbar x % P19	Edits parameter.	Accepts and saves new parameter setting.	Sequences to next parameter.

Set Pressure Correction











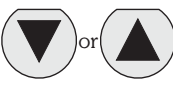

Pressure correction allows the user to set a maximum pressure as a percentage of secondary pressure F.S.

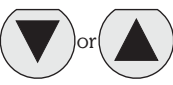
Example: If F.S. is 10 bar, set parameter 19 to 50 for maximum preset pressure of 5 bar.

Pressure correction also affects the minimum preset pressure in parameter 18.

Example: If F.S. is 10 bar and parameter 18 is set to a value of 100 (1 bar), and parameter 19 is set to 50%, then the actual minimum preset pressure seen is 0.5 bar.

Parameter Number 19 – Set Maximum Preset Pressure











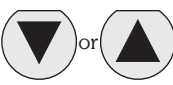

Step	1	2	3	4	5	
Press 	 3-6 seconds					
Until Display Reads			 Flashing Decimal	 Flashing Decimal (value between 0 and 100)	 Flashing	
Description	Accesses changeable parameters.	Accesses parameter no. 19.	Displays current parameter value. Incremental value is: % of F.S.	Edits parameter.	Accepts and saves new parameter setting.	Sequences to next parameter.

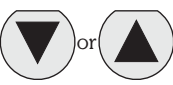
Behavior Control

The regulation speed of the pressure regulator can be modified by means of one parameter. (P 20)

The value in this parameter has a range from 0-5. A higher value indicates slower regulation speed, but will be more stable.

Parameter Number 20 – Set Behavior Control

Step	1	2	3	4	5	
Press 	 3-6 seconds					
Until Display Reads			 Flashing Decimal	 Flashing Decimal (value between 0 and 5)	 Flashing	
Description	Accesses changeable parameters.	Accesses parameter no. 20.	Displays current parameter value.	Edits parameter 0 = custom set* 1 = fastest (narrow proportional band) 2 = fast 3 = normal 4 = slow 5 = slowest (proportional band is broad)	Accepts and saves new parameter setting.	Sequences to next parameter.











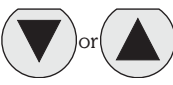

* When the value 0 is entered, you are able to create your own custom settings true parameters 12, 13 and 21.

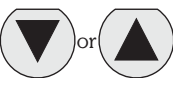
Fine Settings

Set Proportional Band

Proportional band is used for setting the reaction sensitivity of the regulator. The displayed value is X 10 mbar and has a range between 50 (0.5 bar) and 250 (2.5 bar).









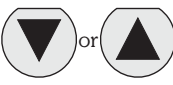

Parameter Number 12 – Set Proportional Band (P20 Must be Set to 0)

Step	1	2	3	4	5	
Press 	 3-6 seconds					
Until Display Reads			 Flashing Decimal	 Flashing Decimal (value between 50 and 250)	 Flashing	
Description	Accesses changeable parameters.	Accesses parameter no. 12.	Displays current parameter value. Incremental value is: x 10 mbar	Edits parameter.	Accepts and saves new parameter setting.	Sequences to next parameter.

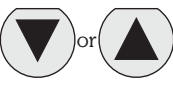
Set Deadband

Deadband is the minimum limit of accuracy at which the regulator is set for normal operation. The displayed value is X 10 mbar and has a range between 4 (40 mbar) and 40 (400 mbar).



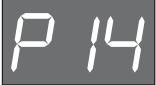







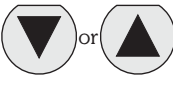

Parameter Number 13 – Set Deadband (P20 Must be Set to 0)

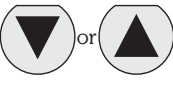
Step	1	2	3	4	5	
Press 	 3-6 seconds					
Until Display Reads			 Flashing Decimal	 Flashing Decimal (value between 4 and 40)	 Flashing	
Description	Accesses changeable parameters.	Accesses parameter no. 13.	Displays current parameter value. Incremental value is x 10 mbar	Edits parameter.	Accepts and saves new parameter setting.	Sequences to next parameter.







Proportional Effect

Sets the speed at which the regulator adjusts either filling or exhausting. The displayed value has a range between 5 (fastest regulation) and 100 (slowest regulation).

Parameter Number 21 – Set Proportional Effect (P20 Must be Set to 0)

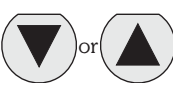
Step	1	2	3	4	5	
Press 	 3-6 seconds					
Until Display Reads			 Flashing Decimal	 Flashing Decimal (value between 5 and 100)	 Flashing	
Description	Accesses changeable parameters.	Accesses parameter no. 21.	Displays current parameter value.	Edits parameter. 5 = fastest regulation 100 = slowest regulation.	Accepts and saves new parameter setting.	Sequences to next parameter.

Parameter Number 39 – Displays Current Software Version

Step	1	2	3	
Press 	 3-6 seconds			
Until Display Reads			 Flashing Decimal	
Description	Accesses changeable parameters.	Accesses parameter no. 39.	Displays current parameter value. XXX = current software version	

ER09

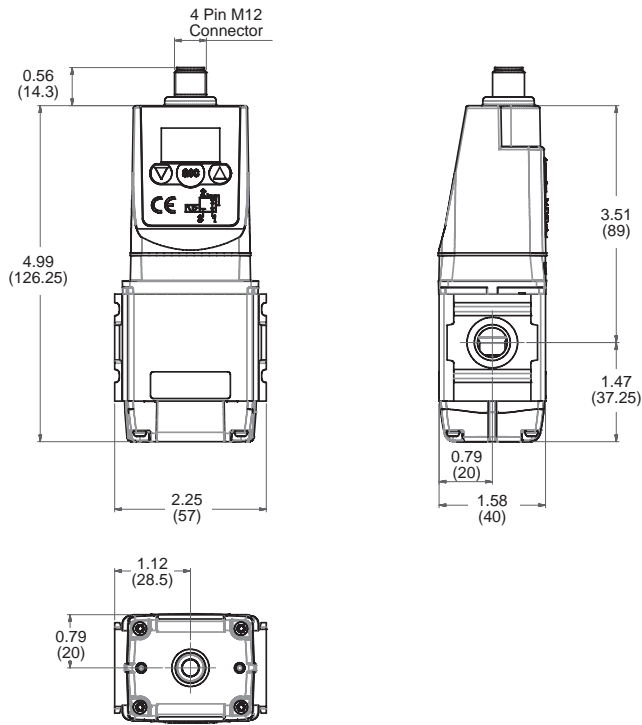

ER19

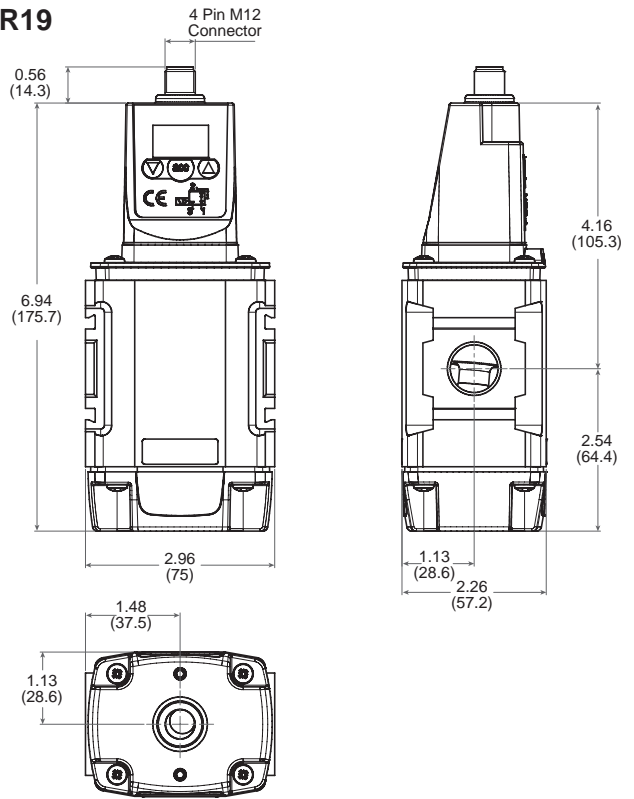

L-Bracket

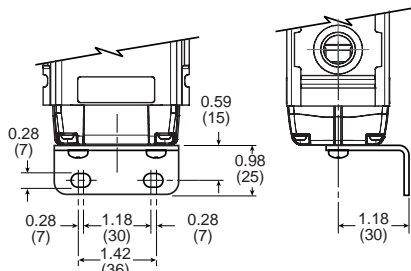

L-Bracket

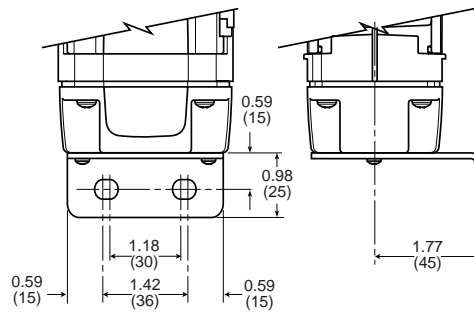

Foot Bracket

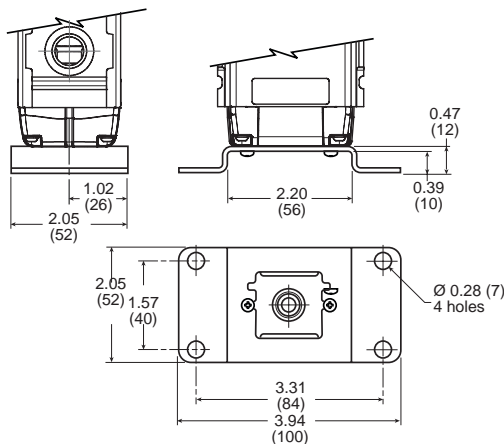

Foot Bracket

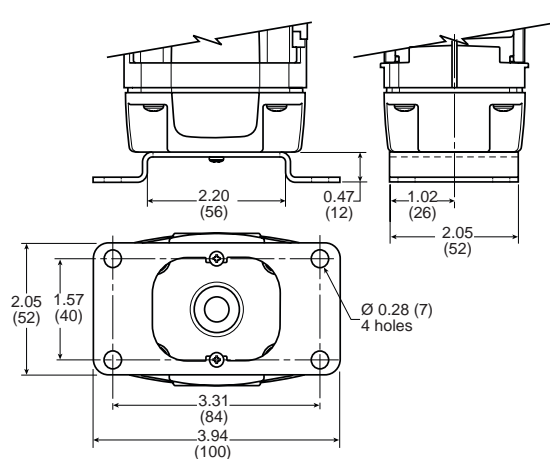

Dimensions are in inches (mm)

Troubleshooting Guide

Problem	Possible Reason	Solution
Display will not light up	No 24 volts power supply	Check if the wiring is connected according to the schematic wiring diagram
Unit will not, or not correctly respond to given setpoint	Wrong current applied (I.e. Volt instead of mA or mA instead of Volt Setpoint signal is not stable enough	Change setpoint current or re configure the setpoint current through the software by changing parameter 4 Check wiring if the setpoint signal lead is connected to the right pin within the male M12 connector (should be pin 2) Stabilize setpoint signal input
Display shows NoP.	Unit detects that required output pressure is higher than the supplied pressure No inlet pressure at all	Adjust the inlet pressure to a higher value, preferably 0,5 bar higher than requested output pressure Give lower setpoint value which corresponds to a output pressure lower than the inlet pressure Connect port 1 to the supply pressure
Unit behavior is not considered normal	Faulty settings made in the parameters	Reset the unit to factory settings by using the green key function under parameter 0
Desired pressure can not be reached	Setpoint value to low Pre-set pressure limit has been changed to a lower max. outlet pressure Supply pressure is to low	Increase setpoint value Change max. outlet pressure back to required pressure by changing parameter 19 Increase supply pressure
Secondary side stays pressurized	Setpoint value is higher than 0,1 Volt Pre-set pressure has been enabled to a certain pressure	Lower your setpoint value, preferably to 0 Volts Reset parameter 18 to 0
Display shows unrealistic value	Display maybe configured in the wrong value (bar instead of psi)	Check through parameter 14, if the display value is set on either psi or bar, if necessary change it to the required setting
Unit response time too slow or too quick	Volume behind the unit is either too big or too small	Adjust the regulating speed of the unit through parameter 20
Unit gives too much overshoot	Relation between volume and response me is out of balance	Adjust response time to a higher value through parameter 20, to achieve more accurate behavior
Unit is adjusting/regulating constantly	Air leakage in the system behind the unit Constant changing volume behind the unit "Deadband "area is set too small	Resolve leakage Unit needs to regulate to keep required pressure at the same level Try to minimize the volume changes Enlarge deadband setting through parameter 13 in the software (parameter 20 has to be set to 0 before changing parameter 13)
Can not enter software through touchpad	Unit is currently working/processing Activating time is too short	Make sure that the unit is in steady state while activating the software Hold the accept button for at least 3 seconds
Display indicates 'OL'	Wiring not according to diagram (24 volt connected on the setpoint connection pin) Wrong setpoint value given in relation to programmed setpoint value acceptance	Rewire so that on the setpoint connection pin will be either 0-10v or 4-20mA Change over setpoint value to either V or mA or Reprogram the unit to the correct setpoint value via parameter 4
Any other problem	Please consult factory	

Glossary

Hysteresis – The mechanical limits of accuracy of the unit. The regulator cannot be adjusted within the inherent mechanical limits of the design.

Dead Band – The minimum limit of accuracy at which the regulator is set for normal operation. This band must be equal to, or exceed, the inherent design limits of the regulator or the hysteresis band.

Proportional Band – The band used for setting reaction sensitivity of the regulator. The regulator senses the excursion from the set pressure and adjusts response in relation to the degree of excursion beyond the dead band. This band must exceed the dead band of the unit.

Proportional Effect – The speed at which the unit approaches P2 (secondary pressure).

Sensitivity – The smallest change in the control signal, or feedback signal, to cause a change in regulated output pressure.

Repeatability – a measurement of how consistently the unit can reproduce an output pressure in relation to a specific set pressure.

Linearity – A measure of how closely the relationship of output pressure vs. the control signal deviates from a straight line function.

PNP Output – Referred to as a “Sourcing” open collector transistor output where the voltage sources towards 24VDC when activated.

NPN Output – Referred to as a “Sinking” open collector transistor output. The output sinks towards 0VDC when activated.

Safety Guide
For more complete information on recommended application guidelines, see the Safety Guide section of Pneumatic Division catalogs or you can download the Pneumatic Division Safety Guide at: www.wilkersoncorp.com