

ATX™ UPR Series 32 Amp Plugs and Sockets

Increased Safety

ATEX/IECEX:
Zone 1 and 2 - 21 and 22
II 2 GD
IP66 - IK09

Appleton

PLUGS AND RECEPTACLES: ATEX/IECEX FLAMEPROOF

Applications

- Plugs and sockets are used with portable or stationary electrical equipment such as:
 - Lighting systems
 - Conveyors
 - Heaters
 - Motor generators
 - Air conditioning equipment
 - Compressors
 - Pumps
- For use in corrosive atmospheres and installations in Zone 1 and 2 and 21 and 22 of the oil and gas industry, such as:
 - Refineries
 - Chemical and petrochemical plants
 - Pipelines
 - Loading docks
 - Onshore and offshore drilling platforms

Features

- Plug and socket system is designed with a mechanical interlock to insure disengagement cannot occur while energized.
- Large ON/OFF actuator on the receptacle gives clear, visible indication of the receptacle status for maximum hazardous location protection.
- Low Voltage receptacle can be locked in 0 (Off) and 1 (On) positions.
- Different voltages are color coded for easy identification.
- The receptacles are keyed to accept UPR plugs of the proper voltage.
- Receptacle explosionproof switch.
- UPR plugs can be used in non-hazardous IEC 60309-2 sockets.
- Operating temperature of -20 °C to +55 °C (-4 °F to +131 °F)

Standard Materials

- Wall Socket: polyamide
- Plug: polyamide

ATEX/IECEX Certifications and Compliances

- Certification Type UPR
 - Gas: Zones 1 and 2
 - Conforming to ATEX 94/9/CE: II 2 G
 - Type of Protection: Ex db eb IIB
 - Temperature Class: T6 for Ta ≤ +40 °C (+104 °F) and T5 for +55 °C (+131 °F)
 - Dust: Zones 21 and 22
 - Conforming to ATEX 94/9/CE: II 2 D
 - Type of Protection: Ex tb IIIB
 - Surface Temperature: T79 °C [Ta +40 °C (+104 °F)]; T94 °C [(Ta +55 °C (+131 °F))]
- Ambient Temperature: -20 °C ≤ Ta ≤ +55 °C (-4 °F ≤ Ta ≤ +131 °F)
- Index of Protection according EN/IEC 60529: IP66
- Impact Resistance (shock): IK09
- CE Declaration of Conformity: 50311
- ATEX Certificate: LCIE 15 ATEX 3054X
- IECEX Certificate: IECEX LCIE 15.0044X



Plug



Wall Mounting Socket

Technical Data

Breaking Capacity		
AC3	32 Amp	690 Vac
AC22	32 Amp	690 Vac

Short Circuit Withstand (ICC) : 10kA

ATX™ UPR Series 32 Amp Plugs and Sockets

Increased Safety

ATEX/IECEX:
Zone 1 and 2 - 21 and 22
II 2 GD
IP66 - IK09



Wall Mounting Socket

- Two M32 threaded entries on the bottom or top upon request.
- Supplied with one M32 cable gland – Ø 10 to Ø 25 mm (0.39 to 0.98 in) and one M32 blanking plugs.
- Terminal capacity 2 x 6 to 10 mm² (#10 to #8 AWG). Can be through-wired up to 6mm² (#10 AWG).
- Fitted with two linked earth terminals.



Plug

- One integrated cable clamp – Ø 14.1 to Ø 29.1 mm (0.55 to 0.98 in) for 3P+N+E versions.
- Terminal capacity 6 to 10 mm² (#10 to #8 AWG).

LV - Low Voltage

Yellow	Blue	Red	Black
100/130 Vac	200/250 Vac	380/415 Vac	480/500 Vac
			600/690 Vac









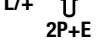

ATX™ UPR Series 32 Amp Plugs and Sockets

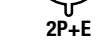
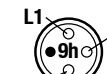
Increased Safety

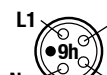
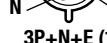
ATEX/IECEX:
Zone 1 and 2 - 21 and 22
II 2 GD
IP66 - IK09

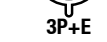
Appleton

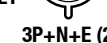
PLUGS AND RECEPTACLES: ATEX/IECEX FLAMEPROOF

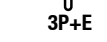
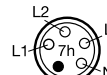
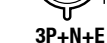
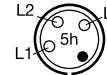
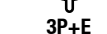
Description	Pin Configuration	Weight kg (lb)	Volume dm ³ (in ³)	Color	Catalog Number
100/130 Vac 50/60 Hz - Yellow					
Wall Socket		1.71 (3.77)	11.30 (689.57)	Yellow	UPR332RY4
Plug		0.46 (1.01)	2.40 (146.46)	Yellow	UPR332PY4
200/250 Vac 50/60 Hz - Blue					
Wall Socket		1.71 (3.77)	11.30 (689.57)	Blue	UPR332RB6
Plug		0.46 (1.01)	2.40 (146.46)	Blue	UPR332PB6
Wall Socket		1.85 (4.08)	11.30 (689.57)	Blue	UPR432RB9
Plug		0.49 (1.08)	2.40 (146.46)	Blue	UPR432PB9
Wall Socket		1.91 (4.21)	11.30 (689.57)	Blue	UPR532RB9
Plug		0.54 (1.19)	2.40 (146.46)	Blue	UPR532PB9
	(1) 120/208 V - 144/250 Vac 50/60 Hz				
380/415 Vac 50/60 Hz - Red					
Wall Socket		1.85 (4.08)	11.30 (689.57)	Red	UPR432RR6
Plug		0.49 (1.08)	2.40 (146.46)	Red	UPR432PR6
Wall Socket		1.91 (4.21)	11.30 (689.57)	Red	UPR532RR6
Plug		0.54 (1.19)	2.40 (146.46)	Red	UPR532PR6
	(2) 200/346 V - 240/415 Vac 50/60 Hz				
480/500 Vac 50/60 Hz - Black					
Wall Socket		1.85 (4.08)	11.30 (689.57)	Black	UPR432RN7
Plug		0.49 (1.08)	2.40 (146.46)	Black	UPR432PN7
Wall Socket		1.91 (4.21)	11.30 (689.57)	Black	UPR532RN7
Plug		0.54 (1.19)	2.40 (146.46)	Black	UPR532PN7
600/690 Vac 50/60 Hz - Black					
Wall Socket		1.85 (4.08)	11.30 (689.57)	Black	UPR432RN5
Plug		0.49 (1.08)	2.40 (146.46)	Black	UPR432PN5

ATX™ UPR Series 32 Amp Plugs and Sockets

Increased Safety

ATEX/IECEX:
 Zone 1 and 2 - 21 and 22
 II 2 GD
 IP66 - IK09

Dimensions in Millimeters (Inches)

32A – 2P+E – 3P+E – 3P+N+E Versions

Wall Mounting Sockets

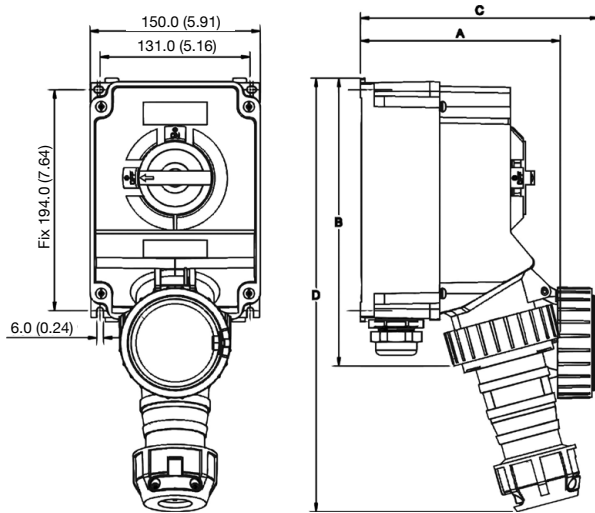

Plugs

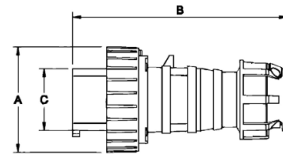

	Dimensions in Millimeters (Inches)			
	A	B	C	D
2 P + E	175.0 (6.89)	250.0 (9.84)	210.0 (8.27)	380.0 (14.96)
3 P + E	175.0 (6.89)	250.0 (9.84)	210.0 (8.27)	380.0 (14.96)
3 P + N + E	177.0 (6.97)	250.0 (9.84)	210.0 (8.27)	380.0 (14.96)

	Dimensions in Millimeters (Inches)		
	A	B	C
2 P + E	98.0 (3.86)	200.0 (7.87)	57.0 (2.24)
3 P + E	98.0 (3.86)	200.0 (7.87)	57.0 (2.24)
3 P + N + E	102.0 (4.02)	200.0 (7.87)	63.0 (2.48)