



Installation and Maintenance Instructions for GC51 Rangeable Pressure Transmitter



LOOK FOR THIS
AGENCY MARK ON
OUR PRODUCTS

Version 6.03 5/11

CONTENTS

CAUTION	5
1. PREFACE	6
2. OVERVIEW	6
3. FEATURES	6
4. SPECIFICATION	7
5. MOUNTING	8
5.1 Mounting Location	8
5.2 Mounting Options	9
5.3 Pressure Connection	9
6. DIMENSIONS	10
7. WIRING	10
7.1 Cable / Wiring Specifications	10
7.2 Wiring Instructions	10
8. DISPLAY FUNCTIONS	14
9. MODE CHANGES	15
10. POWER-ON MESSAGE	15
11. MEASUREMENT MODE	16
11.1 Filter (Damping)	16
11.2 Pressure Display Mode (Re-scaling in "psi" units)	16
11.3 Linear Display Mode (Re-scaling in arbitrary user defined units)	18
11.4 Min/Max Display	21
11.5 Out of Range Display	22
12. ZERO ADJUSTMENT MODE	23
13. KEY LOCK	23
14. SETTING MODE	23
14.1 Setting Items for Pressure Display Mode (Re-scaling in "psi" units)	23
14.2 Setting Items for Linear Display Mode (Re-scaling in arbitrary user defined units)	25
14.3 Setting Procedure	27
14.4 Loop Check	28
15. MAINTENANCE & SERVICE	30



WARNING! READ BEFORE INSTALLATION



1. GENERAL:

A failure resulting in **injury** or **damage** may be caused by excessive overpressure, excessive vibration or pressure pulsation, excessive instrument temperature, corrosion of the pressure containing parts, or other misuse. Consult Ashcroft Inc., Stratford, Connecticut, USA before installing if there are any questions or concerns.

2. OVERPRESSURE:

Pressure spikes in excess of the rated overpressure capability of the transducer may cause **irreversible electrical and/or mechanical damage** to the pressure measuring and containing elements.

Fluid hammer and surges can destroy any pressure transducer and must always be avoided. A pressure snubber should be installed to eliminate the damaging hammer effects. Fluid hammer occurs when a liquid flow is suddenly stopped, as with quick closing solenoid valves. Surges occur when flow is suddenly begun, as when a pump is turned on at full power or a valve is quickly opened.

Liquid surges are particularly damaging to pressure transducers if the pipe is originally empty. To avoid damaging surges, fluid lines should remain full (if possible), pumps should be brought up to power slowly, and valves opened slowly. To avoid damage from both fluid hammer and surges, a surge chamber should be installed.

Symptoms of fluid hammer and surge's damaging effects:

- Pressure transducer exhibits an output at zero pressure (large zero offset).
- Pressure transducer output remains constant regardless of pressure
- In severe cases, there will be no output.

FREEZING:

Prohibit freezing of media in pressure port. Unit should be drained (mount in vertical position with electrical termination upward) to prevent possible overpressure damage from frozen media.

3. STATIC ELECTRICAL CHARGES:

Any electrical device may be susceptible to damage when exposed to static electrical charges. To avoid damage to the transducer observe the following:

- Ground the body of the transducer **BEFORE** making any electrical connections.
- When disconnecting, remove the ground **LAST!**

Note: The shield and drain wire in the cable (if supplied) is not connected to the transducer body, and is not a suitable ground.

1. PREFACE

Thank you for purchasing the GC51 Rangeable Pressure Transmitter. In order to utilize this product safely please note the preceding warning comments. Refer to Ashcroft Bulletin GC-51 for product specifications and applicable operating conditions.

2. OVERVIEW

The GC51 is a 4-20ma loop powered (two-wire) pressure transmitter with display incorporating Ashcroft's polysilicon thin film sensing element which provides high cycle life, excellent overpressure ratings, high stability and durability. Digital compensation techniques are employed to provide an accurate output over the stated pressure and temperature range. The compact design was meant to serve typical industrial applications involving tank level monitoring, pump control, hydraulic system monitoring and control, compressor control and process automation.

3. FEATURES

- A. Linear Scaling Function:** The linear (scaling) zero and span values, 4-20mA output signal, are adjustable by the user and the display will show the proportional output in units noted.
- B. Maximum / Minimum Hold Function:** Captures the maximum and minimum pressure values as experienced by the GC51.
- C. Digital Filter Function:** User adjustable damping of the output signal by means of internally calculated moving average to provide a stable output signal in applications where the user wants to reduce the pulsating of the display and / or output signal.
- D. LED Back Light:** To supplement the LCD display when conditions require (dark area, night etc.).
- E. Loop Check Function:** Allows the user to output an analog signal corresponding to pressure without applying pressure, simplifying system maintenance and troubleshooting.
- F. Zero and Span Adjustment:** The adjustment of the Zero (4mA) and Span (20mA) reading is user friendly via internal push buttons.
- G. Key Lock:** Prevents inadvertent overwriting of setting values. Can not be reset by restoring power when activated.
- H. Rotatable Display:** The user can adjust the display in 90 degree increments allowing for ease of reading with flexibility in mounting orientation.
- I. IP65/ NEMA 4X Environmental Rating:** Enclosure environmental rating suitable for indoor and outdoor installation, depending upon operating temperature range.
Note: Display not to be mounted in direct sunlight.

4. SPECIFICATION

Item: Description

A. Media / Wetted Parts:

Fluids or gases compatible with 316SS and 17-4PH SS

B. Overpressure (Proof):

-1500 psi FS and below; 200% FS value

-3000, 5000 psi; 150% FS value

-7500 psi; 120% FS value

C. Supply Voltage: 12-32 Vdc

D. Output:

4 to 20mA dc (two wire, output range: 3.2 to 20.8mA dc)

Response Time: 30 ms (with "0" filter setting)

Resolution: 0.1%F.S., Load resistance: 500ohms max.

E. Accuracy: $\pm 0.25\%$ F.S. (URL) includes the effects of linearity, hysteresis and repeatability at 23°C (73°F) reference temperature

F. Temperature Effects

Operating and compensated temperature range (-10 to +60 °C);

$\pm 0.02\%$ F.S. (URL)°C from 23°C reference.

G. Rangeability / Adjustment:

Zero: -10 to +110% FS

Span: -10 to + 110% FS

H. Display Accuracy: $\pm 0.25\%$ F.S. (URL) +1digit at 23°C

I. Display:

Character height: 10mm, LCD with LED backlight

Pressure / linear display: four LCD digits max.; 3½ digit

Display update: 500 ms

J. Units: Pressure Units: psi (2), (1) arbitrary

K. Setting Adjustments:

- Internal key switches
- Scaling function: Linear display / output
- Max / Min function: Both the maximum and the minimum readings can be indicated.
- Filter function: User adjustable output damping, select from 0, 2, 4, 8, and 16 (0 = 30ms, 2 = 60ms, 4 = 120ms etc.)
- Loop check function: User adjustable output for loop / system check and troubleshooting, 4 to 20mA
- Key lock function

L. Pressure Connection: ¼ NPT Female

M. Enclosure:

Material: Aluminum (die cast)

Environmental Rating: IP65 / NEMA 4X

N. Mounting:

Pressure Port Location: Lower (bottom)

Panel mounting: via bracket included

Location: compliant with environmental ratings and where display does not get direct sunlight

O. Electrical Termination:

Cable Gland: Cable diameter 0.35 to 0.47" (9-12 mm)

Terminal block: 14-22 AWG (strand or a solid wire)

½ NPT female conduit (optional)

P. Memory Protection:

Permanently stored by EEPROM (nonvolatile memory)

Q. EMC Directive:

CE Compliance: EN61326/1997, A1/1998, A2/2001

R. Operating Temperature: -10 to 60°C (14 to 140°F)

S. Storage Temperature: -20 to 70°C (-4 to 158°F)

T. Vibration: 5g's 60Hz; x, y, z (2.5 hours for each)

U. Shock: 10g's 60Hz; x, y, z (3 times forward and backwards each axis)

V. Insulation Resistance: 50Vdc, 100m Ohm minimum

W. Breakdown Voltage: 250Vac for 1 minute

X. Weight: Approx. 450g (1.0 lb)

5. MOUNTING

5.1. Mounting Location

- Non-hazardous rated area (no combustible gas or liquids)
- Compliant with operating temperature specifications
- Without display receiving direct sunlight
- Compliant with IP65 / NEMA 4X environmental rating
- Within vibration and shock specification

5.2. Mounting Options

Direct connection to pressure ports with suitable piping and / or pressure fitting or with bracket included for panel mounting. If using cable it is recommended that the cable exit downward.

5.3. Pressure Connection

- A. Only apply wrench to pressure port flats, DO NOT apply force to the housing. Clear tubing of any debris (metal filings etc) and unwanted fluids (oil etc).
- B. If using the panel mounting bracket minimize force applied from the piping and ensure piping is parallel to the pressure port centerline.

6. DIMENSIONS

Dimensions in inches

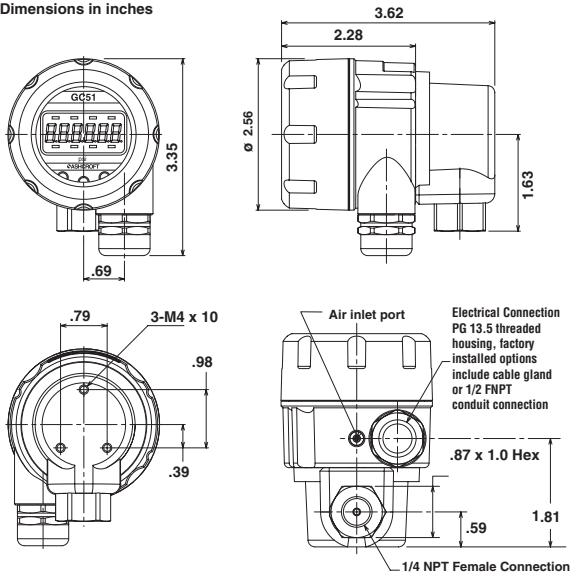

Installation Drawings

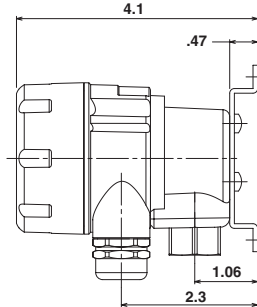
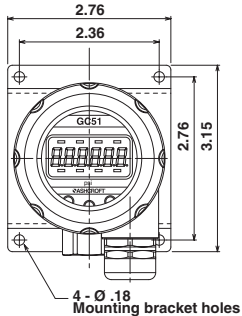

7. WIRING

Power supply requirements, 12 -32 Vdc, note installation recommendations below.

7.1 Cable / Wire Specifications

Terminal Strip	SMKDSP1.5/2-5.08 Phoenix contac
Cable Requirements	<ul style="list-style-type: none"> • Two core shielded cable • Cable outer diameter: 0.35 to 0.47" (9-12mm). Required for proper installation with cable gland option • Wire Gauge: 14-22 AWG (multi-strand or solid)

7.2 Wiring Instructions

- To reduce potential for noise do not run pressure transmitter cable / wires alongside (same conduit as) high voltage (line power) lines. For optimum results use dedicated conduit for GC51 cable / wires.
- If using the Cable Gland termination option must use cable within previously noted diameters to maintain environmental ratings.
- When connecting shield / drain wire, only connect one end which should be at the receiver ground.

- Wiring stripping instructions, remove cable jacket 2-3" and strip wires 0.25". Shield / drain wire should not be exposed at the pressure transmitter termination.
- Remove cover and carefully remove the display to access the terminal strip, take care not to mishandle the display and associated electronics.

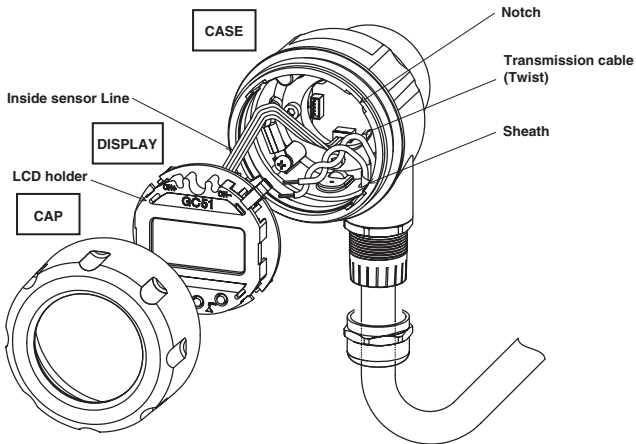
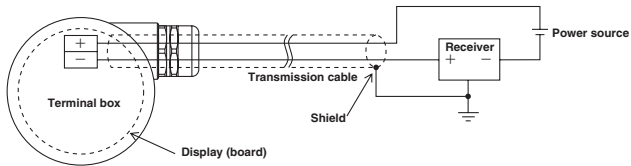

- Turn display over to expose terminal strip, make positive and negative connections, insert wire depth is equal to recommended strip length (0.25").

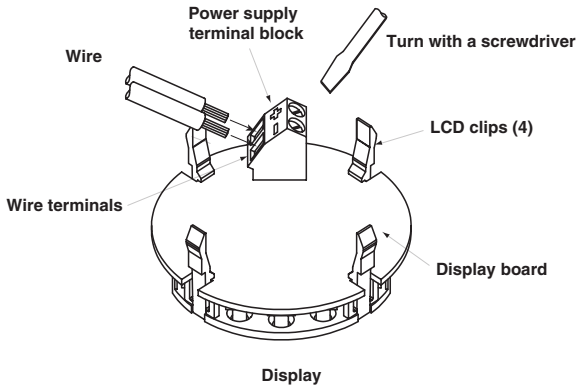

- After completing connections locate retaining clips in the appropriate notches and carefully place into the housing. Be sure that internal sensor ribbon cable does not cross the power supply lines just installed.
- If using the Cable Gland be sure to properly tighten sealing grommet before applying any tension on the cable, the cable gland provides strain relief and environmental sealing.
- Tighten GC51 cover to maintain environmental rating.
- Connect to power source and receiver and power on to confirm correct wiring.
- Power Supply Requirements: Although the 4-20mA signal can travel over long distances one of the most common problems is inadequate power at the pressure transmitter due to the voltage drop across the loop. Be sure to review table below to determine that 12-32V is getting to the pressure transmitter.

Load Limitations 4-20mA Output Only

Loop Resistance (Ω)

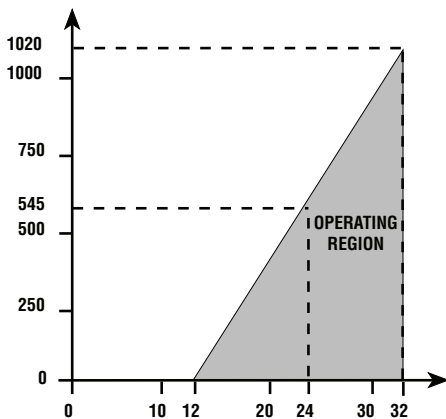

LOOP SUPPLY VOLTAGE

$$V_{\min} = 12V + [.022A * R_L]$$

*Includes a 10% safety factor

$$R_L = R_S + R_W$$



R_L = Loop Resistance (ohms)

R_S = Sense Resistance (ohms)

R_W = Wire Resistance (ohms)

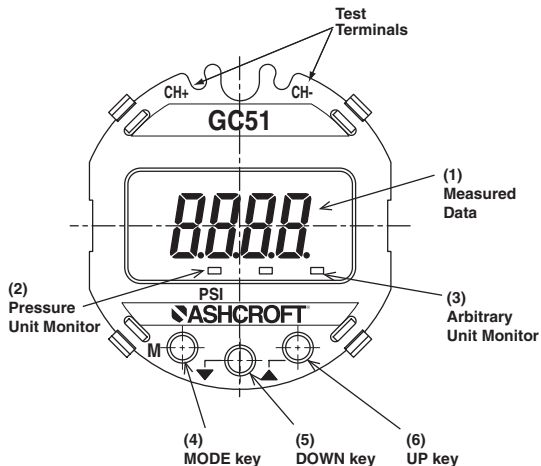
8. DISPLAY FUNCTIONS



Designation	Function
1. Measured Data Display	Pressure, linear scaling value, hold value (max./ min), are displayed.
2. Pressure unit monitor	When either indicator is ON, the display is reading in PSI.
3. Arbitrary unit monitor	When this indicator is ON, the linear scaling value of an arbitrary unit is indicated on the display.
4. MODE button 	Used to switch the setting mode, the measurement mode and the setting item.
5. DOWN button 	Used to change (decrease) and select the set value and to zero-reset the hold function.
6. UP button 	Used to change (increase) and select the set value and to shift from the measurement mode to the zero adjustment mode.

9. MODE CHANGES

- Measurement Mode (Section 11 for further detail) will be entered upon power-on. Setting Mode (Section 13 for further detail) is entered by pressing and holding the MODE button for more than 3 seconds. If there is no button operation for 10 minutes in the setting mode, it will shift back to the Measurement Mode automatically.
- To go from the Measurement Mode to the Zero Adjustment Mode (Section 12 for further detail) press and hold the UP  button for more

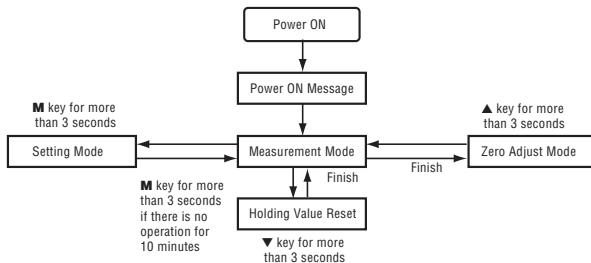

10. POWER-ON MESSAGE

After the power is turned on, the power-on message is displayed for 6 seconds as shown below and then the display is shifted to the measurement mode (section 13).

In addition, the analog output during power-on message is at zero point (4mA).

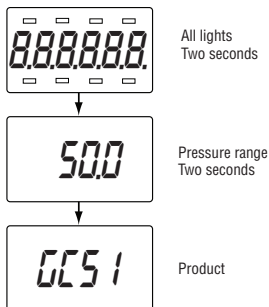

11. MEASUREMENT MODE

The measurement mode includes pressure display mode and linear (scaling) display mode.

11.1 Filter (Damping)

Set the filter before setting pressure display mode or linear (scaling) display mode.

The filter is based on the moving average of the pressure data to decrease display “bounce” and to smooth the analog output due to system pressure fluctuations at the user’s discretion.

Five selections: 0, 2, 4, 8, and 16 where 0=30ms (and in this case the filter is not active), 2=60ms, 4=120ms, 8=240ms, 16=480ms.

Note: see page 24 for full menu.

Filter setting	⇒ Setting item ①
----------------	------------------

11.2 Pressure Display Mode (Re-scaling in “psi” units)

This mode is used for the display and analog output of the actual pressure.

A. Analog Output

The analog output can be adjusted as follows; the zero point (4mA) and the span point (20mA) can each be adjusted from -10 to 110%F.S. (URL).

- This means that although the zero point is typically set at 0%F.S. and the span point is set as 100%F.S., the zero point can be adjusted to the point where zero (4mA) is 110%F.S. and the span point (20mA) can be adjusted to -10%F.S. thus reversing the output. In addition, through this adjustment zero and span can be adjusted accordingly for elevated tank levels.

B. Pressure Display

- The pressure display has a display span between the zero point and the span point as determined by the adjustment of zero and span (see previous paragraph) and can display the range of -5 to 105%F.S.(URL). In addition, the decimal point position of the pressure display is fixed for each pressure range.
- Pressure Units: psi

Note: see page 24 for full menu.

Select the filter of "8 times"	⇒ Setting item ①
Select the "Pressure display mode"	⇒ Setting item ②
Set output zero point as "10.0%F.S." (10 psi)	⇒ Setting item ③
Set output span point as "90.0%F.S." (90 psi)	⇒ Setting item ④

Setting Example 1: Pressure Display Mode

Using a standard pressure range of 0 to 100 psi, the steps to change the display and analog output zero and span points to 10 and 90 psi respectively are as follows: First, set the Filter. In this case set at 8 times (where the output is based upon the moving average equivalent to the pressure data per 30ms for 8 "periods" (240ms).

After Power On, hold "M" button >3 seconds to enter Setting Mode. Display will show "U xxx" (version control), press "M" to enter Filter selection option, display will show "F" and the setting, use Up and Down arrow keys for desired setting. To move from Setting item 1 to 2 (etc.) press M, when desired Setting function has been completed hold the "M" button for greater than 3 seconds to return to Measurement Mode.

Note: see page 24 for full menu.

FURTHER DETAIL of the menu and button sequence is shown in Sections 14.1-14.3.

Pressure Display and Analog Output

	Pressure Display		Analog Output
	PSI		mA
Output span point	90	⇒	20
	50	⇒	12
Output zero point	10	⇒	4

While in Setting Mode press "M" button until display shows "A 000.0", using Up and Down arrow keys adjust to desired setting which is set as a % of FS, thus to display and output 10psi adjust using Up Key until "10.0" is showing, then press "M," display will show "A 100.0" which is for Span adjustment as a %FS, thus using Down key adjust value to "90.0" which will correspond to 90psi (20mA) as the new Full Scale value.

11.3 Linear Display Mode (Re-scaling arbitrary user defined units)

This mode is used for display/analog output of the scaling value where the pressure is linearly converted to an arbitrary physical quantity (user defined, GC51 is supplied with display unit "PSI"). FURTHER DETAIL regarding menu and button sequence is shown in Section 14.2-14.3.

A. Linear display

By setting the OFFSET to the minimum pressure P1 and the FULL SCALE to the maximum pressure P2, the linear display indicates the value on the line between the two points (the maximum display span). The actual linear display span depends on the setting of the zero point and span point of the analog output as shown in (2) of the next page. It can display the range of -5 to 105%F.S. of the linear display span.

- The setting range for the minimum pressure P1 and the maximum pressure P2 is 0 to 100%F.S. of the pressure range. The maximum pressure P2 is set from the value which is more than 25% FS of the pressure range above the minimum pressure P1.
- The setting range for the OFFSET and FULL SCALE values is -1999 to 1999 , and the decimal point can be set arbitrarily. At this time, the arbitrary unit monitor turns on (farthest indicating light at the bottom right of display).

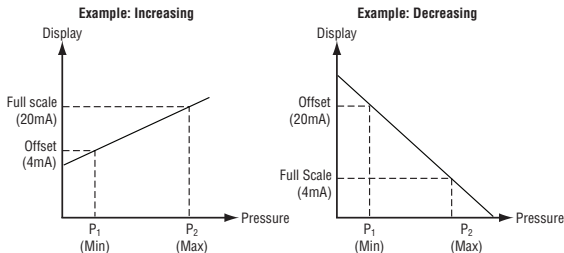

Note: see page 24 for full menu.

Min. pressure P1 & max. pressure P2 setting ⇒ Setting item ⑥, ⑦

OFFSET & FULL SCALE setting ⇒ Setting item ⑧, ⑨, ⑩

B. Analog Output

The zero point (4mA) and span point (20mA) of the analog output can be set in the range of 10 to 110%F.S. of the maximum display span (between OFFSET and FULL SCALE).The span between the zero point and the span point in this analog output is the linear display span.

Note: see page 24 for full menu.

Analog output zero point & span point setting	⇒ Setting item ⑪, ⑫
---	---------------------

- As shown in the graph on the left, the OFFSET is set as Output zero point (4mA) and the FULL SCALE is set as Output span point (20mA), but the OFFSET can be reversed to Output span point (20mA) and the FULL SCALE can be reversed to Output zero point (4mA).

Setting Example 2 : Linear Display Mode

In this example the desire of the user is to use the GC51 as a “load meter” with the arbitrary unit being “ton”. Using a pressure range of 0 to 100psi, Setting Mode to display the OFFSET for minimum pressure 10psi as 0.00, the FULL SCALE for maximum pressure 60psi as 5.00, the unit as arbitrary unit (ton), the zero point (4mA) of analog output as 0.00, and the span point (20mA) as 5.00 is as follows.

FURTHER DETAIL regarding menu and button sequence is shown in Section 14.3.

For display mode, select “Linear display mode”	⇒ Setting item ②
Set min. pressure P1 as “10 psi”	⇒ Setting item ⑥
Set max. pressure P2 as “60 psi”	⇒ Setting item ⑦
Set decimal point position of linear display as “two digit”	⇒ Setting item ⑧
Set OFFSET of linear display as “0.00” ton	⇒ Setting item ⑨
Set FULL SCALE of linear display as “5.00” ton	⇒ Setting item ⑩
Set output zero point as “0.0%F.S.” (0.00ton) of max. display span	⇒ Setting item ⑪
Set output span point as “100.0%F.S.” (5.00ton) of max. display span	⇒ Setting item ⑫

Maximum display span: OFFSET to FULL SCALE

Linear display and Analog



output

	Pressure (psi)	⇒	Linear Display (ton)	⇒	Analog Output (mA)	
 <div style="border: 1px solid black; padding: 2px; display: inline-block;">ton</div>	60	⇒	5.00	⇒	20	Span Point
	f		f		f	
	35	⇒	2.50	⇒	12	
	10	⇒	0.00	⇒	4	Zero Point

11.4 Minimum / Maximum Display



In Pressure Display Mode or Linear Display Mode the maximum and minimum values are captured into nonvolatile memory (EEPROM). The following steps describe how to display these values.

A. Maximum Value

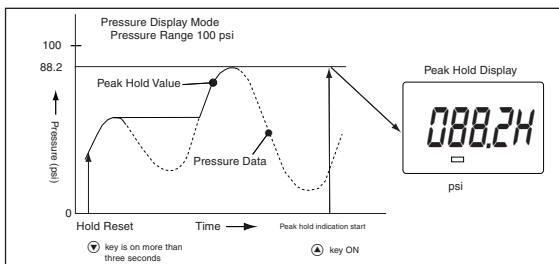
In Measurement Mode (either pressure or linear indication mode), press UP  button to display the maximum value. The letter "H" will follow the reading indicating this is the maximum value. Press the UP  button again to return to Measurement Mode. Note: If the button is held for 3 seconds it will go into zero adjustment mode.



B. Minimum Value

In Measurement Mode (either pressure or linear indication mode), press DOWN  button to display the minimum value. The letter "L" will follow the reading indicating this is the minimum value. Press the DOWN  button again to return to Measurement Mode.

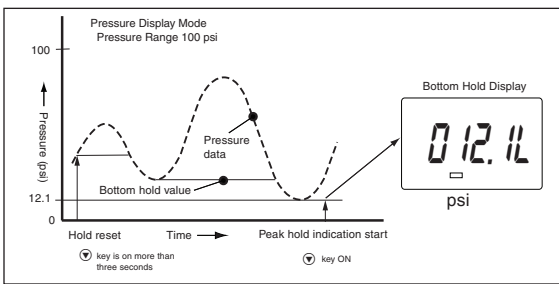

C. Minimum / Maximum Reset

The Minimum / Maximum values can be reset when in either Minimum / Maximum display or Measurement Mode by holding the DOWN  button for more than three seconds, “cLr” will appear on the display for two seconds and the Minimum and Maximum values will be removed.

Note: Values are maintained even if unit is powered OFF.

Hold reset message

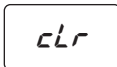

- When first using unit be sure to Reset values to clear values in memory from the factory calibration process.
- Values are captured starting one minute after Reset, thus if unit is powered OFF during the one minute the values during that period will not be kept in memory.

11.5 Out of Range Display

A. Out of Range Display

In the Measurement Mode, if the pressure is below -15% F.S. (URL) “-FFF” will be displayed, and if it is more than 115%F.S., “FFF” will be displayed.

B. Out of Span Display

When the user has adjusted the span of the device this will apply. The display range in each display mode is -5 to 105%F.S. of the display span. When this range is exceeded, the value of -5%F.S. or 105%F.S. will be held (depending upon whether unit is below or above the span values) in a blinking state.

C. Analog Output

The analog output is linked with the display and is at 3.2mA when the display span is at or exceeded -5%F.S. and at 20.8mA when the display span is at or greater than 105%F.S. .

Example: Out of Range Display

Pressure display (Pressure range: 0-100 psi)

Pressure display span: 0-50 psi

Span point: 1.000

Zero point: 0.000

-15%F.S. (-15 psi) or less

-115%F.S. (115 psi) or more

• **Range Over display**



• Span Over display

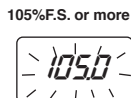
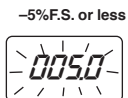

12. ZERO ADJUSTMENT MODE

When in Measurement Mode the zero reading can be adjusted. To adjust the zero reading be sure the pressure connection port (or the system to which it is connected) is open to atmosphere and hold the UP button for more than 3 seconds. This is not to be used for scaling of the output, refer to Section 11.2 and 11.3 for scaling function.

- If the zero point adjustment is performed correctly the message “Adj” will be displayed for 2 seconds, and the display will return to the measurement mode.
- If zero point adjustment has been attempted when the pressure is outside of $\pm 10\%$ F.S. the error message “E-0” will be displayed for 2 seconds, and the display will return to the measurement mode without completing the zero point adjustment.

Normal message



Error message

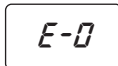

It is important to perform the zero adjustment when the user is certain that the device is at atmospheric pressure otherwise an offset may be introduced which will impact the accuracy of the device.

13. KEY LOCK

Function	Key Manual	Indicator
Setting of key lock	MODE+ one second	LoC (Key invalidity)
Release of key lock	MODE+ one second	UnL (Key invalidity)

Operation during keylock

Function	Key Manual	Indicator
Zero adjust. mode	key greater than 3 sec.	LoC (Key invalidity)
Hold value reset	key greater than 3 sec.	LoC (Key invalidity)
Setting mode	M key greater than 3 sec.	LoC (Key invalidity)
Peak indicator	one push	Peak indicator
Bottom indicator	one push	Bottom indicator

14. SETTING MODE

The setting mode includes access to pressure display mode and linear display mode. In addition loop check (section 13.4) can be performed in each mode.

14.1 Setting Items for Pressure Display Mode (Re-scaling in “psi” units)

Set the filter before setting the pressure setting mode

Note: see page 24 for full menu.

No.	Setting Item	LCD Display	Setting Description	Setting Range	Default*
①	Filter		Selection of moving average time of pressure : 8 (times)	1,2,4,8, 16 times	4

*The default is the factory default.

The following table is the setting. Example 1, Pressure Display Mode, Section 11-2. This applies when re-scaling in “psi” units.

No.	Setting Item	LCD Display	Setting Description	Setting Range	Default*
②	Display mode		Selection of pressure display mode : non	non:pressure display mode Lin: linear display mode	non
③	Output zero point†		Analog output zero point (4mA) : 10.0 (%F.S.)	Pressure range: -10 to 110%F.S.	0.0
④	Output span point‡		Analog output span point (20mA) : 90.0 (%F.S.)	Pressure range: -10 to 110%F.S.	100.0
⑤	Loop check‡		Arbitrary change of pressure display and analog output : 10 psi	Display: Output zero point pressure to span point pressure Analog output 4 to 20mA	0.0 (4mA)

†For setting of zero point and span point in the analog output, input the percent value over the pressure range.

‡Regardless of applied pressure, the loop check can be activated, refer to Section 13.4. This example shows the LCD display at the zero point at the start of loop check start.

14.2 Setting Items for Linear Display Mode (Re-scaling in arbitrary user defined units)

Set the filter before setting the linear display mode (Refer to Section 11.1). The following table is the Setting Example 1, Linear Display Mode, Section 11-3. This applies when re-scaling in arbitrary user defined units.

No.	Setting Item	LCD Display	Setting Description	Setting Range	Default*
②	Display mode		Selection of pressure display mode : Lin	non:pressure display mode Lin:Linear display mode	non
⑥	Minimum pressure†		Min. pressure corresponding to OFFSET 9 : 10 (psi)	Pressure range 0 to 75%F.S.	0.0
⑦	Maximum pressure†		Max. pressure corresponding to FULL SCALE 10 : 60 (psi)	Pressure range 25 to 100%F.S.	100.0
⑧	Decimal point position		Display after decimal point Number of digits : 2 (digit)	0,1,2,3 digit	0
⑨	OFFSET		OFFSET corresponding to min. pressure 6 : 0.00 (ton)	-1999 to 1999	0
⑩	FULL SCALE		FULL SCALE corresponding to mAX. pressure 7 : 5.00 (ton)	-1999 to 1999	1000
⑪	Output zero point††		Analog output zero point (4mA) : 0.0 (%F.S.)	Maximum display span: -10 to 110%F.S.	0.0
⑫	Output span point††		Analog output span point (20mA) : 100.0 (%F.S.)	Maximum display span: -10 to 110%F.S.	100.0
⑬	Loop check‡		Arbitrary change of linear display and analog output : 5.00 (ton)	Display: linear display Analog output 4 to 20mA	0.00 (4.0mA)

†In the setting of a pressure, the decimal point position is fixed for each pressure range. (Refer to section 10, Power-on Message). The maximum pressure can be set from the value which is more than 25%F.S. of the pressure range above the minimum pressure. The values under 25%F.S. cannot be increased or decreased by ▲ ▼ key.

‡For setting of zero point and span point in the analog output, input the percent value over the maximum display span (between OFFSET and FULL SCALE). Its decimal point position can be set up to one digit after decimal point as fixed point.

‡Regardless of applied pressure, the loop check can be activated, refer to Section 13.4. This example shows the LCD display at the span point.

14.3 Setting Procedure

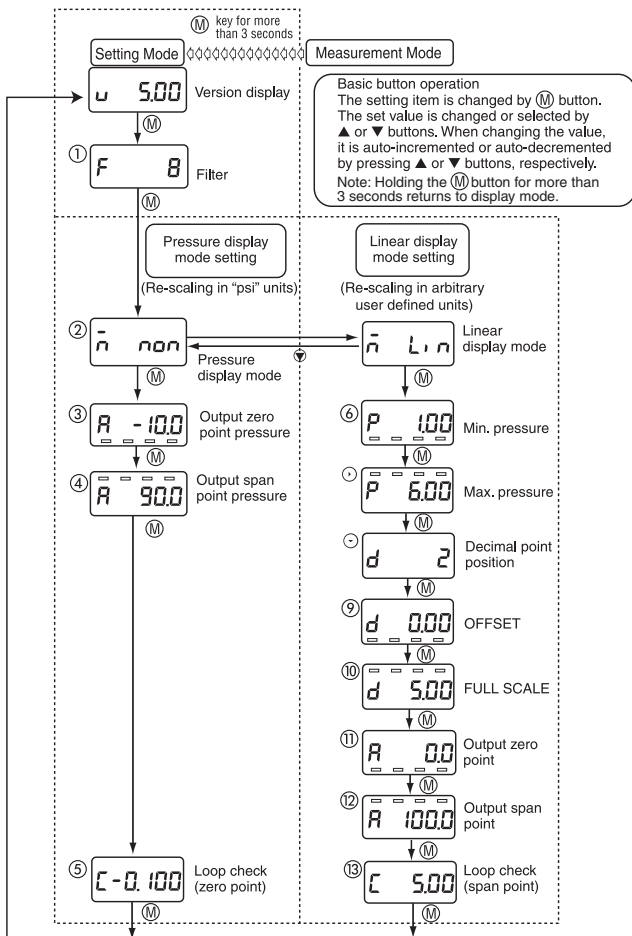

14.4 Loop Check

In each display mode, regardless of applied pressure, the loop check can be activated by following the push button sequence in Section 13.1 and 13.2. This will link the display with the analog output. This allows for checking wiring, receivers, general troubleshooting etc.

- Loop check method (Linear Display Mode)
 1. Turn and remove the lid of this product.
 2. Shift to the linear display mode in the setting item ②. (Refer to Section 13.2, Setting Procedure). The display at the time of loop check start (zero point) and the analog output (4mA) are held.
 3. If ▲ button continues to be pressed, the linear display will auto-increment by linkage between the linear display and the analog output. By continuing to press ▼ button, auto decrement will occur. Release the button at the desired indication. For example, if the button is released at 2.50(ton), the display will stop and be held at analog output 12mA corresponding to the indication.

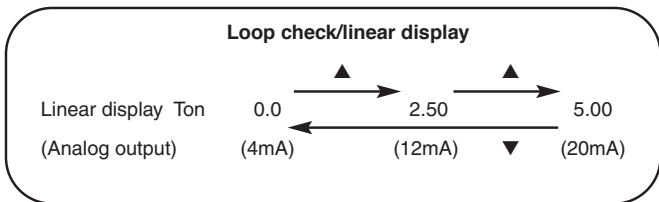

- Analog output terminal check

When the front cover is removed, the analog output check terminals (pad: CH+, CH-) are visible at the upper part of the display substrate. The analog output can be checked during measurement mode or loop check by applying a probe such as a tester for current measurement, as shown in the following figure. In addition, receivers are not affected.

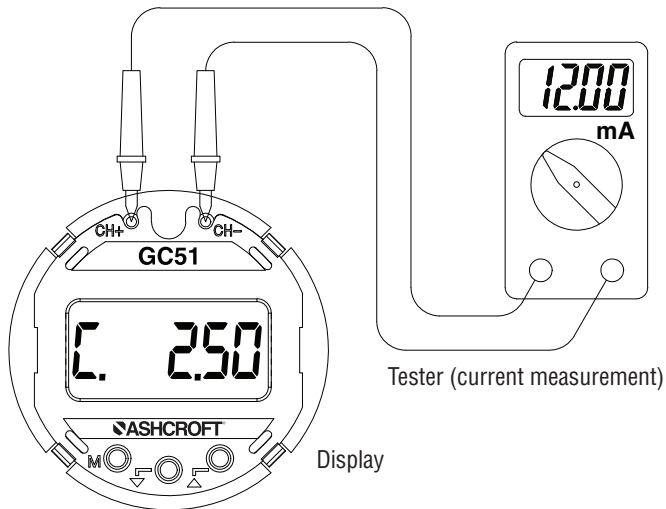

15. MAINTENANCE & SERVICE

- **Periodic inspection**

Depending upon the type of use periodic inspection is recommended at least once a year.

Please refer to the following items for periodic inspection:

1. Appearance
2. Display/output check via appropriate pressure standard.⁽¹⁾
3. Display/output check via Loop Check⁽²⁾

- Avoid ESD. When cleaning this product, please use soft, damp, cloth.
- Do not use thinner, etc. which may cause deterioration and failure.

- **Product warranty**

Except as otherwise provided, the product warranty of this product is as follows:

Period: 12 months after delivery

Warrantable defects: Defects resulting from the design and manufacture of our company, the quality of the material, etc.

Implementation of warranty: This warranty will be completed by substitution or repair of the product concerned.

- If you have any questions about this document, please contact the sales office or distributor nearest you.
- This document is subject to change without notice.

⁽¹⁾ Adjust zero point accordingly. Refer to Section 12, Zero Adjustment Mode.

⁽²⁾ In addition to this product, remote receivers can easily be checked. (Refer to Section 13.4, Loop Check).

© 2011 Ashcroft Inc. 250 East Main Street, Stratford, CT 06614 USA
Tel: 203-378-8281, Fax: 203-385-0402 www.ashcroft.com
All sales subject to standard terms and conditions of sale.
I&M011-10159_Rev. C_6.03_GC51