

# AL Ball and Cushion Flexible Fixture Hangers

UNILETS® for Use with Threaded Rigid Metal Conduit and IMC. Ball Joint Permits 20° Swing.

**NEC:**

Listed for Ordinary (Unclassified) Locations

## Applications

- Designed for suspension of HID, fluorescent and incandescent lighting fixtures.
- Functions as combination conduit outlet box and hanger.

## Features

- Protects fixture against wind and vibration damage.
- Cushion type for added protection where lighting fixtures are subjected to vibration.
- Dual function—conduit outlet box and fixture hanger.
- Choice of ball or cushion type.
- Swivel joint construction—allows 20° swing from vertical.
- Cushion style, with conical spring, supports up to 54 kg (120 lbs).
- Cushion type has setscrew for locking fixture stem.
- Fixture and hanger stem can be wired at work bench.
- Connection block available for convenient wiring of fixture leads.

## Standard Materials

- Malleable iron with steel cover

## Standard Finishes

- Malleable iron parts: triple-coat—(1) zinc electroplate, (2) chromate, and (3) epoxy powder coat
- Steel parts: zinc electroplate

## NEC Certifications and Compliances

- UL Listed: E109438



ALA — Ball Hanger



ALC — Ball Hanger



ALL — Cushion Hanger



ALT — Cushion Hanger

## Illustrated Features

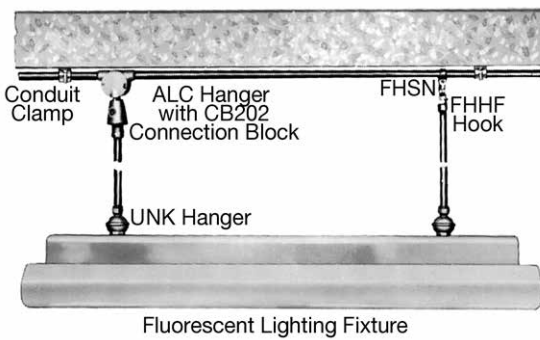





POLES/HANGERS: NEC/CEC ORDINARY LOCATION FLEXIBLE FIXTURE HANGERS



# AL Ball and Cushion Flexible Fixture Hangers

UNILETS® for Use with Threaded Rigid Metal Conduit and IMC. Ball Joint Permits 20° Swing.

NEC:  
Listed for Ordinary (Unclassified) Locations

	Conduit Size (Inches)	Fixture Stem Size (Inches)	Support Weight kg (lbs)	Catalog Number
<b>ALA – Ball Hanger</b>				
	1/2	1/2	112.5 (250)	ALA50-B
	3/4	1/2		ALA7550-B
	3/4	3/4	112.5 (250)	ALA75-B
<b>ALA – Cushion Hanger – Furnished with a 3/4" to 1/2" reducer for 1/2" stems</b>				
	1/2	3/4 or 1/2	1.4 to 5.4 (3 to 12)	ALA50-12
	3/4	3/4 or 1/2		ALA7575-12
	1/2	3/4 or 1/2	5.4 to 21.6 (12 to 48)	ALA50-48
	3/4	3/4 or 1/2		ALA7575-48
	1/2	3/4 or 1/2	21.6 to 54.0 (48 to 120)	ALA50-120
	3/4	3/4 or 1/2		ALA7575-120
<b>ALC – Ball Hanger</b>				
	1/2	1/2	112.5 (250)	ALC50-B
	3/4	1/2		ALC7550-B
	1	1/2		ALC1050-B
	3/4	3/4	112.5 (250)	ALC75-B
	1	3/4		ALC1075-B
<b>ALC – Cushion Hanger – Furnished with a 3/4" to 1/2" reducer for 1/2" stems</b>				
	1/2	3/4 or 1/2	1.4 to 5.4 (3 to 12)	ALC50-12
	3/4	3/4 or 1/2		ALC7575-12
	1	3/4 or 1/2		ALC1075-12
	1/2	3/4 or 1/2	5.4 to 21.6 (12 to 48)	ALC50-48
	3/4	3/4 or 1/2		ALC7575-48
	1	3/4 or 1/2		ALC1075-48
	1/2	3/4 or 1/2	21.6 to 54.0 (48 to 120)	ALC50-120
	3/4	3/4 or 1/2		ALC7575-120
	1	3/4 or 1/2		ALC1075-120

POLES/HANGERS: NEC/CEC ORDINARY LOCATION FLEXIBLE FIXTURE HANGERS





Appleton®

# AL Ball and Cushion Flexible Fixture Hangers

UNILETS® for Use with Threaded Rigid Metal Conduit and IMC. Ball Joint Permits 20° Swing.

**NEC:**

Listed for Ordinary (Unclassified) Locations

	Conduit Size (Inches)	Fixture Stem Size (Inches)	Support Weight kg (lbs)	Catalog Number
<b>ALL – Ball Hanger</b>				
	1/2	1/2	112.5 (250)	ALL50-B
	3/4	1/2		ALL7550-B
	3/4	3/4	112.5 (250)	ALL75-B
<b>ALL – Cushion Hanger – Furnished with a 3/4" to 1/2" reducer for 1/2" stems</b>				
	1/2	3/4 or 1/2	1.4 to 5.4 (3 to 12)	ALL50-12
	3/4	3/4 or 1/2		ALL7575-12
	1/2	3/4 or 1/2	5.4 to 21.6 (12 to 48)	ALL50-48
	3/4	3/4 or 1/2		ALL7575-48
	1/2	3/4 or 1/2	21.6 to 54 (48 to 120)	ALL50-120
	3/4	3/4 or 1/2		ALL7575-120
<b>ALT – Ball Hanger</b>				
	1/2	1/2	112.5 (250)	ALT50-B
	3/4	1/2		ALT7550-B
	1	1/2		ALT1050-B
	3/4	3/4	112.5 (250)	ALT75-B
	1	3/4	112.5 (250)	ALT1075-B
<b>ALT – Cushion Hanger – Furnished with a 3/4" to 1/2" reducer for 1/2" stems</b>				
	1/2	3/4 or 1/2	1.4 to 5.4 (3 to 12)	ALT50-12
	3/4	3/4 or 1/2		ALT7575-12
	1	3/4 or 1/2		ALT1075-12
	1/2	3/4 or 1/2	5.4 to 21.6 (12 to 48)	ALT50-48
	3/4	3/4 or 1/2		ALT7575-48
	1	3/4 or 1/2		ALT1075-48
	1/2	3/4 or 1/2	21.6 to 54 (48 to 120)	ALT50-120
	3/4	3/4 or 1/2		ALT7575-120
	1	3/4 or 1/2		ALT1075-120

POLES/HANGERS: NEC/CEC ORDINARY LOCATION FLEXIBLE FIXTURE HANGERS









# AL Ball and Cushion Flexible Fixture Hangers

UNILETS® for Use with Threaded Rigid Metal Conduit and IMC.

NEC:  
Listed for Ordinary (Unclassified) Locations

POLES/HANGERS: NEC/CEC ORDINARY LOCATION FLEXIBLE FIXTURE HANGERS

	Size (Inches)	Support Weight kg (lbs)	Catalog Number
<b>AL – Hanger Bodies</b>			
 <p><b>ALA</b></p>	1/2	(Refer to Cushion and Ball Fixture Stems Below)	<b>ALA50</b>
	3/4		<b>ALA75</b>
 <p><b>ALC</b></p>	1/2	(Refer to Cushion and Ball Fixture Stems Below)	<b>ALC50</b>
	3/4		<b>ALC75</b>
	1		<b>ALC100</b>
 <p><b>ALL</b></p>	1/2	(Refer to Cushion and Ball Fixture Stems Below)	<b>ALL50</b>
	3/4		<b>ALL75</b>
 <p><b>ALT</b></p>	1/2	(Refer to Cushion and Ball Fixture Stems Below)	<b>ALT50</b>
	3/4		<b>ALT75</b>
	1		<b>ALT100</b>
<b>AL – Ball Fixture Stem</b>			
	1/2	112.5 (250)	<b>BJ50</b>
	3/4		<b>BJ75</b>
<b>AL – Cushion Fixture Stems</b>			
Fixture stem tapped for 3/4"; 3/4" to 1/2" reducer furnished for 1/2" stems. With setscrew for locking fixture stem.			
	3/4 or 1/2	1.4-5.4 (3-12)	<b>CJC75-12</b>
	3/4 or 1/2	5.4-21.6 (12-48)	<b>CJC75-48</b>
	3/4 or 1/2	21.6-54.0 (48-120)	<b>CJC75-120</b>
<b>AL – Porcelain Connection Block</b>			
	2 Wire, 20 Amp, 277 Volt Maximum Wire Size Two No. 10 AWG Large Terminal Two No. 14 AWG Small Terminal		<b>CB202</b>

## AL Fixture Hanger Dimensions – Millimeters (Inches)

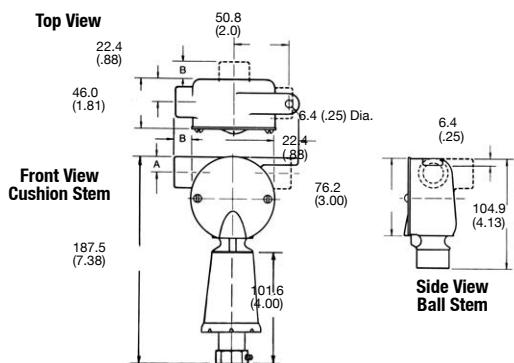

Conduit Trade Size	Dimensions in Millimeters (Inches)	
	A	B
1/2"	4.2 (0.56)	17.5 (0.69)
3/4"	17.5 (0.69)	17.5 (0.69)
1"	22.4 (0.88)	20.6 (0.81)