



# High-Integrity Pressure Protection System (HIPPS)

Dependable pressure protection for downstream systems

# HIPPS

## Dependable pressure protection for downstream systems

When operating in high-pressure environments and production fields, an overpressure event can cause damage to the environment, infrastructure, and personnel. Mitigating that risk on production wells and flowlines is a challenge that can be met with a HIPPS.

A HIPPS is designed and built in accordance with IEC 61508 and IEC 61511 standards. These international standards refer to safety functions and safety instrumented systems when

discussing a solution to protect equipment, personnel, and environment. A system that closes the source of overpressure within the required timeframe and incorporates redundancy within the initiators (pressure sensors), logic solver, and final elements (shutdown valves) with at least the same reliability as a safety relief valve is usually identified as a HIPPS.

### Applications

- Wellhead flowline
- Pipeline and compressor stations
- Flaring systems
- Separation and processing facilities
- Gas plants
- Gas storage
- Floating production storage and offloading (FPSO) vessels
- Offshore platforms
- Onshore operations

A HIPPS is a safety instrumented system designed to prevent overpressurization of a piping system and processing facility.

### Benefits

- Protects downstream equipment
- Minimizes flare system requirements
- Reduces weight of downstream systems
- Maximizes system availability
- Reduces high-pressure pipelines or vessel overpressure risk
- Improves economic viability of a development
- Reduces risk to a facility, plant, or flowline
- Reduces the total load of relief in a relief or flare system

### Features

- High-integrity, flexible mechanical and electronic design
- Pneumatic and hydraulic actuator options (conventional or compact)
- Self-contained hydraulic system
- Partial- or full-stroke testing (automated or mechanical)
- SIL 3 certified design
- System diagnostics and status feedback
- Conformance to safety regulations and environmental policies



*Mechanical HIPPS skid in Saudi Arabia.*

## Hydraulic HIPPS

The hydraulic (mechanical) HIPPS provides a self-contained, independent protection system operated on demand with one-out-of-two (1oo2) or two-out-of-three (2oo3) (voting) pressure sensor inputs, a hydraulic logic solver, and two spring-return hydraulically actuated safety valves. The unit is typically self powered and can be provided with additional real-time controls via a hydraulic power unit (HPU). This pressurizes the system and opens the safety shutdown valves. The system remains open (armed) until an abnormal condition is detected. If an abnormal condition is detected, then the system closes the two actuated final element valves, protecting the downstream production or facility.

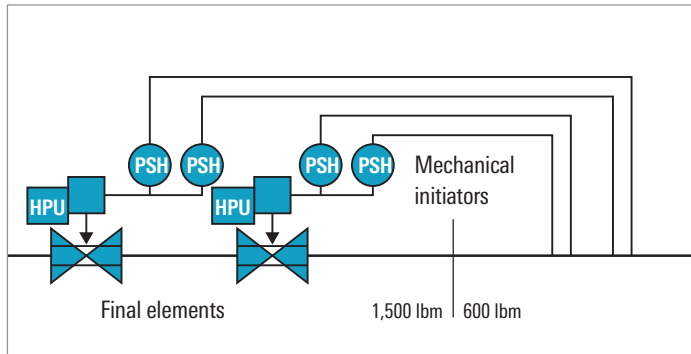

*Hydraulic (mechanical) HIPPS safety loop.*

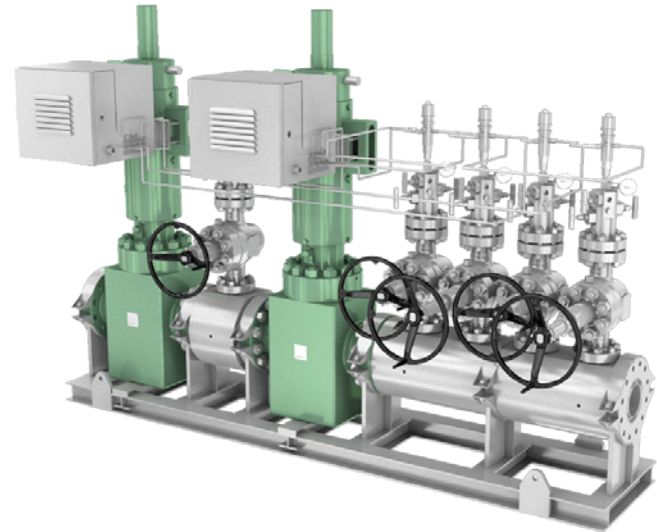

*Hydraulic HIPPS.*

## Electronic HIPPS

The electronic HIPPS is a self-contained, independent system operated on demand with 1oo2 or 2oo3 (voting) pressure transmitter inputs, an electronic logic solver, and two spring-return hydraulically actuated safety valves. The unit can be self powered with a manual hand pump or HPU and can also be configured to operate using facility power sources. This pressurizes the system and opens the safety shutdown valves. The system remains open until an abnormal condition is detected. If such an event is detected, the system closes the two actuated final element valves, protecting the downstream production or facility.

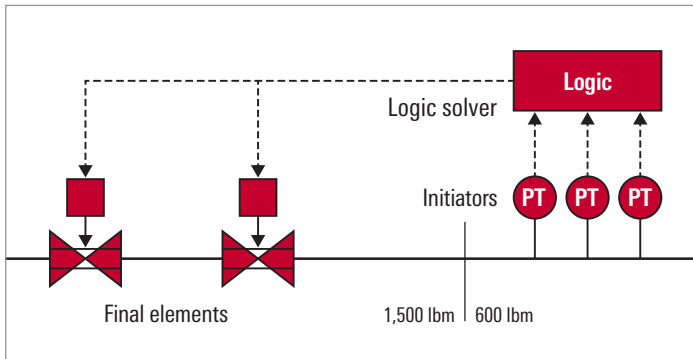

*Electronic HIPPS safety loop.*



*Electronic HIPPS.*

# How a HIPPS Works

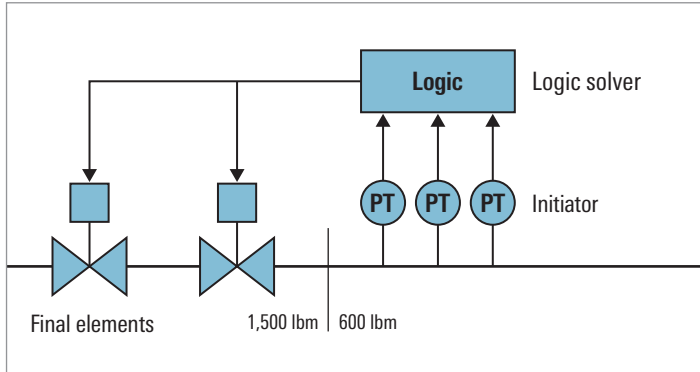

*Typical safety loop.*

The primary function of HIPPS is to detect high-pressure conditions and close isolation valves to protect lower-rated downstream infrastructure. The system operates autonomously and is independent of the facilities' process shutdown (PSD), emergency shutdown (ESD), or control systems. HIPPS are fail-close by design based on the signal of an overpressure event and can be configured to operate on other events, such as a loss of motive power or instrument signal. It is typically fail-close for any loss of instrument air, hydraulic power, electric power, or instrument signals. Each HIPPS loop is independent. A HIPPS is designed with redundant safety functions to reduce the risk of failure on demand and to maximize availability.

# Safety Instrumented Systems

A safety instrumented system (SIS) prevents or reduces hazardous events by taking a process to a safe state when predetermined conditions are met. An SIS can be an ESD, safety interlock system, or safety shutdown system. Each SIS has one or more safety instrumented functions (SIFs).

Each SIF loop is a combination of logic solvers, sensors, solenoids, and final control elements, such as an automated valve. Every SIF within an SIS will have a safety integrity level (SIL), which is a measure of the system performance in terms of probability of failure on demand (PFD). These SIL levels may be the same or may differ depending on the process. An entire system does not need to have the same SIL level for each safety function.

## Advantages

- 25+ years of HIPPS application experience
- Complete solutions provider
- Best-in-class field-proven gate and ball valves
- Best-in-class field-proven linear and quarter-turn actuation
- Global full-service support

### Probability of Failure on Demand

Safety integrity level	Risk reduction factor	Probability of failure on demand
SIL 4	100,000 to 10,000	$10^{-5}$ to $10^{-4}$
SIL 3	10,000 to 1,000	$10^{-4}$ to $10^{-3}$
SIL 2	1,000 to 100	$10^{-3}$ to $10^{-2}$
SIL 1	100 to 10	$10^{-2}$ to $10^{-1}$

Refer to 61508-1 in the IEC Standards.

# HIPPS Components

The Cameron HIPPS comprises two ESD valves, a 1oo2 logic solver, and typically three pressure transmitters with 2oo3 voting logic.

Components include

- sensors that detect high pressures or flow rates 1oo2, 2oo3, or both
- logic solver that processes the input from the sensors to the final element
- SIL 3 rated final elements that bring the process to a final safe state, isolating the source of overpressure.

We manufacture HIPPS to meet customer requirements using the following components:

- complete system design to meet HIPPS standards
- API 6A fail-safe gate valves
- API 6A linear hydraulic spring-return actuators
- API 6D quarter-turn ball valves

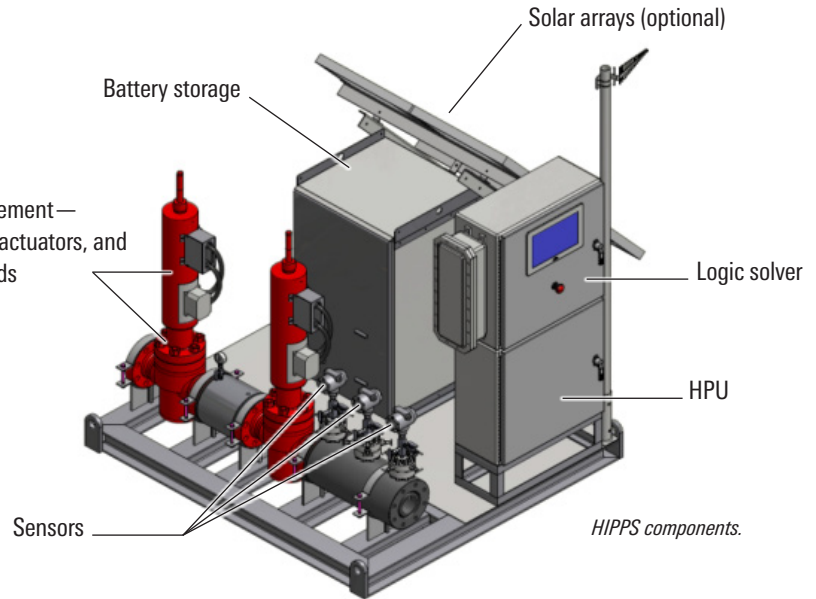

- API 6D quarter-turn or spring-return actuators
- skids designed for HIPPS
- controls or HPU designs (mechanical or electrical with logic solvers)
- solenoid valves
- pressure transmitters
- pressure sensors.



The Cameron HIPPS is an independently instrumented system designed with higher integrity compared with PSD and ESD systems. Suitable for onshore and offshore installations requiring high-integrity pressure protection of downstream systems, a HIPPS is used to prevent a system from exceeding its rated pressure level. The Cameron HIPPS is SIL 3 certified and incorporates our field-proven valves and actuators, such as the FLS\* extreme service API 6A slab-style gate valve and GROVE\* valves. Pneumatic and hydraulic actuators, such as the Saf-T-Gard\* MH Series hydraulic piston actuators and LEDEEN\* actuators, are supplied. A HIPPS is considered the barrier between the high- and low-pressure sections of an installation or production facility.

The HIPPS combines Cameron products into an independent, stand-alone system for any application within the oil and gas industry. Cameron provides the systems in a variety of configurations, including mechanical and electronic standalone packages.

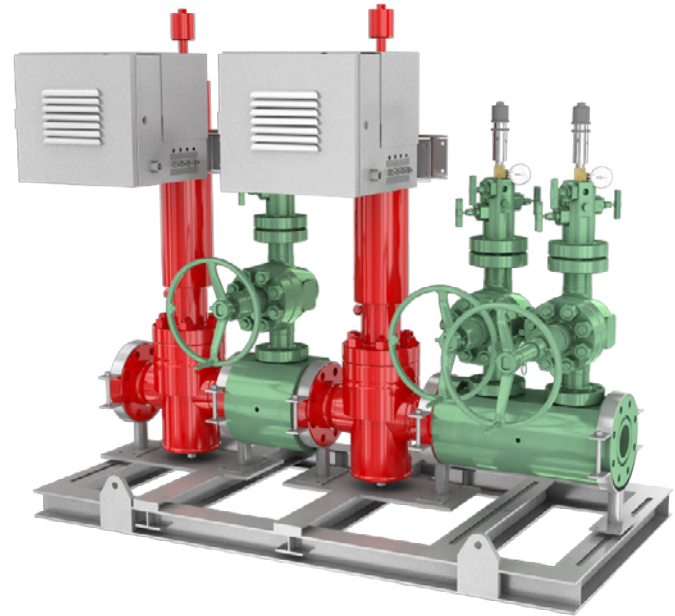

*Each Cameron HIPPS includes two ESD valves (final elements), a logic solver, and pressure transmitters arranged in a configuration that fits individual applications.*

# API 6D Quarter-Turn Actuators

## LEDEEN actuators

Consistent engineering design and efficient modular assembly of LEDEEN actuators increases operational flexibility. The low-pressure-air, high-pressure-gas, and hydraulic products enable on-demand double-acting, spring-fail close-open or manual override operations. This feature maintains product consistency throughout any project requirement, regardless of valve size, class, actuator supply medium, pressure, or actuator function requirements. In addition, the consistent design provides a significant reduction in the quantity of recommended spare parts and seal kits, which reduces costs within maintenance programs.

## Advantages

- Complete controls package designed to meet performance requirements as required
  - Redundancy
  - Partial stroking
  - Diagnostics
  - HPUs
- Fail-safe spring-return and double-acting design

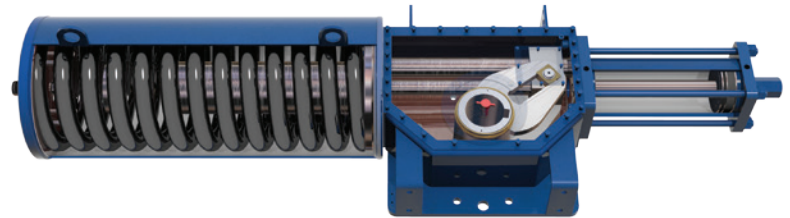

*LEDEEN pneumatic spring-return actuator.*

## DYNATORQUE valve accessories

Cameron is a single-source solution for both standard and customized gears and automated valve accessories, including declutchable and nondeclutchable manual overrides; the DYNATORQUE D-Stop\* partial-stroke test device; the DYNATORQUE D-Lock\* valve-locking device; spur and miter gears; handwheels; and ground position indicators.

### Advantages

- Mechanical partial stroke that does not rely on additional hydraulic or pneumatic controls
- Keyable for manual intervention only or automated for control room diagnostics

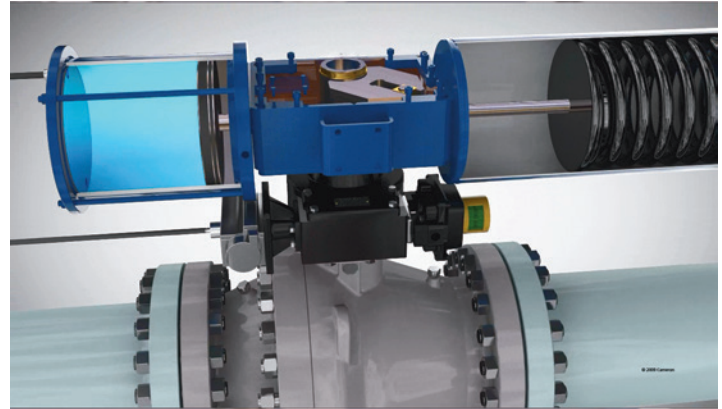
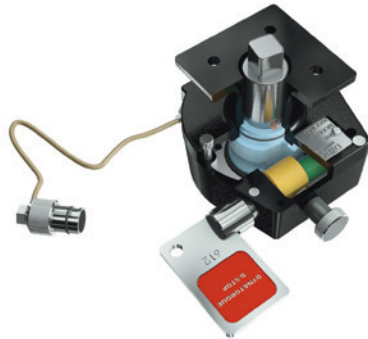

*DYNATORQUE D-Stop partial-stroke test device.*

# API 6D Ball Valves

GROVE side-entry and top-entry trunnion mounted ball valves are designed to API 6A and 6D standards in a wide range of diameters and pressure classes. Split-body construction enables using forged materials in various grades of carbon, stainless, and high-alloy steel, which equips the valves for some of the most severe service conditions. Top-entry valves facilitate maintenance, even when the valves are welded in line, reducing total leak paths.

## Advantages

- Nominal sizes ranging from
  - 1½ in to 60 in
  - ASME Class 150 to Class 2500
  - API 2,000 to 10,000 psi [13.8 to 68.9 MPa]
- Bidirectional design that provides flow direction versatility
- Double-block-and bleed (DBB) capabilities
- Soft or metal-to-metal sealing (for example, ball-to-seat and seat-to-body)
- Self-relieving (SR) or double-piston-effect (DPE) dual-barrier seat sealing design
- Explosive-decompression-resistant thermoplastic or elastomer seals depending on service conditions
- Possibility for both stem and seat emergency injection systems
- Low-fugitive-emissions (FE) stem design options to latest industry standards
- Fire-safe designs
- SIL 3 certification
- Third-party certification available when required

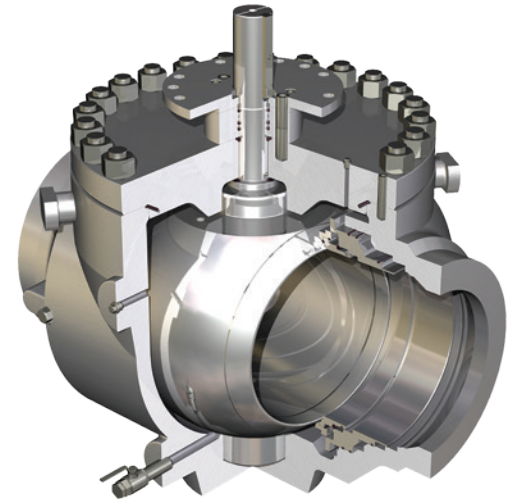

*GROVE BT2 top-entry ball valve.*

# API 6A Hydraulic Actuators

## Saf-T-Gard MH Series hydraulic piston actuators

Designed for use with most manufacturers' gate valves, the Saf-T-Gard MH Series actuators provide a reliable and robust solution for harsh and remote environments. They are recommended for high-thrust applications and for large-bore and high-pressure valves when there is no gas source or when the well gas is too sour.

### Advantages

- Top-mounted power head for ease of maintenance
- Rising stem design that provides visual indication of valve position (also available in nonrising stem)
- 360° of head and housing for optimized positioning of inlet and outlet ports
- Nonpressurized housing for simple and timely seal replacement
- Corrosion-resistant materials with Ever-Slik® corrosion-resistant barrier coating externally coated on all nonstainless-steel components

### Standard actuator specifications

- API 6A actuators for use with 1<sup>13</sup>/<sub>16</sub>-in through 9<sup>1</sup>/<sub>8</sub>-in nominal gate valves
- Piston sizes ranging from 3 in to 14 in
- 6,000-psi maximum operating pressure
- API 6A Appendix F, PR-2 qualification
- SIL rated
- Wide range of options and accessories

### Standard bonnet data

- Standard stem and bonnet materials dependent on temperature class
- Standard bonnet backseat test and packing leak indicator port provided
- Available PSL 1, 2, 3, and 4 qualification

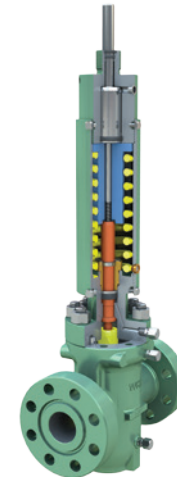

*Saf-T-Gard MH Series hydraulic piston actuator.*

# API 6A Gate Valves

## FL and FLS gate valves

The FL\* API 6A slab-style gate valve and FLS extreme service API 6A slab-style gate valve feature a forged body and are readily adapted to multiple actuator designs. The FL gate valve is available in nominal sizes ranging from 2<sup>1</sup>/<sub>16</sub> in to 4<sup>1</sup>/<sub>8</sub> in and working pressures from 2,000 to 5,000 psi [13.8 to 34.5 MPa]. The FLS gate valve is available in nominal sizes ranging from 1<sup>13</sup>/<sub>16</sub> in to 11 in and working pressures from 2,000 to 20,000 psi [137.9 MPa]. The FLS gate valve is the standard valve for critical requirements, including extreme sour gas applications.

## Advantages

- Bidirectional sealing—The FL gate valve has a symmetrical, bidirectional design without a preferred direction of operation. The seal diameters and bearing areas of the seats are designed to prevent trapping of pressure inside the valve cavity.
- Metal-to-metal sealing—The FL gate valve features bonnet, gate-to-seat, and seat-to-body seals, which all include metal-to-metal sealing.
- Reliability through streamlined design—One-piece floating seats and a floating slab gate provide reliable performance due to the simplicity of operation and a minimum number of sealing interfaces. Cavity clearances are carefully controlled to limit the amount of float needed, and special modified acme threads at the gate-to-stem interface provide sufficient freedom of movement in all directions to affect a positive downstream seal.

- Lip seals—The FL gate valve incorporates one lip seal, and the FLS gate valve incorporates two lip seals between the seat and body. The lip seals are spring-loaded and include pressure-energized, nonelastomeric seals that assist in low-pressure sealing and protect against intrusion of particle contaminants into the body cavity and seal areas.

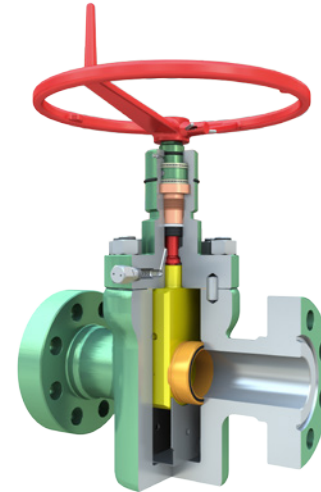

*API 6A gate valve.*

## M Saf-T-Seal gate valve

The M Saf-T-Seal\* API 6A power-actuated fullbore through-conduit gate valve delivers leading sealing performance across a wide range of conditions. This gate valve is available in sizes from 2<sup>1</sup>/<sub>16</sub> in to 4<sup>1</sup>/<sub>16</sub> in, with pressure ratings from 2,000 to 5,000 psi, and with either flanged or threaded connections. The M Saf-T-Seal gate valve is available in trims for most types of oilfield service, including sour gas and API 6A SSV Class I and II applications. The valve can be fitted with a Cameron pneumatic, hydraulic, or electric actuator or with non-Cameron actuators.

### Advantages

- Fullbore, through-conduit API 6A gate valve
- Bidirectional design
- Metal-to-metal sealing at the gate-to-seat and seat-to-body seals
- Seat skirts that reduce loss of valve body lubricant
- Field-replaceable valve cavity parts
- Cast valve body
- API 6A PR-2 qualification

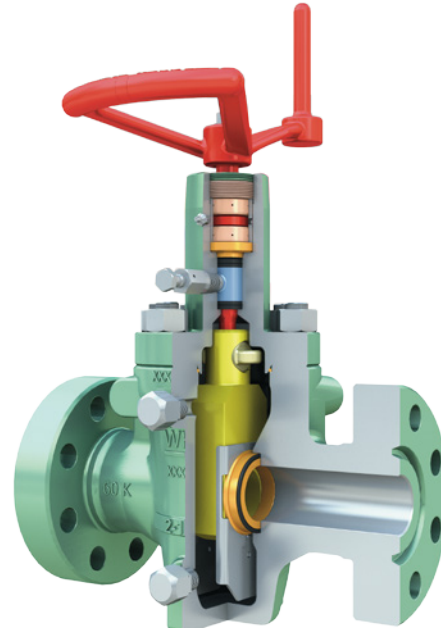

*M Saf-T-Seal API 6A power-actuated fullbore through-conduit gate valve.*

# High-Integrity Pressure Protection System (HIPPS)



\*Mark of Schlumberger  
Other company, product, and service names  
are the properties of their respective owners.  
Copyright © 2016 Schlumberger. All rights reserved. 16-SUR-178595

[cameron.slb.com/HIPPS](http://cameron.slb.com/HIPPS)

