

# ATX™ JBEP Series FRP Terminal Junction Boxes for Electrical and Power Applications

Fiberglass Reinforced Polyester. Increased Safety. Factory Drilled and Equipped.

**NEC/CEC:**  
Class I, Zone 1, AEx e IIC, T5 or T6  
Ex e IIC, T5 or T6  
IP66

**ATEX/IECEX:**  
Zone 1 and 2 – 21 and 22  
Ⓢ II 2 GD  
IP66 – IK10

## Applications

- Electrical junction boxes are used to distribute power to lighting and to other Power and control circuits.
- Power junction boxes are used to connect cables together to supply main lighting circuits, motors, service receptacles and other equipment.
- Designed for Zones 1 or 2 areas, where flammable gases or vapors are present either continuously, often or accidentally such as:
  - Petroleum
  - Chemical
  - Refineries
  - Other industrial process facilities
- Ideal for indoor/outdoor use with wet or corrosive atmospheres.
- Designed for use in Zones 21 or 22 areas where flammables dusts (conductive and non conductive) are present either continuously, often or accidentally such as:
  - Food processing
  - Dairy
  - Brewing
  - Other industrial process facilities

## Features

- Available in multiple terminal configurations.
- Supplied with terminals Size 2.5 mm<sup>2</sup> (14AWG) through 240 mm<sup>2</sup> (474MCM).
- Optional external hinged enclosures:
  - Reversible door opening 120°.
  - Door with double bar lock.
  - Key locking facility.

## Standard materials

- Enclosures: Static resistant carbon filled fiberglass reinforced polyester (FRP)
- Hardware: stainless steel
- Gasket for sizes 85 x 85, 120 x 120: silicone
- Gasket for other sizes: EPDM (ethylene propylene diene monomer rubber)

## Options

- External hinges are available on the following sizes:
  - 500 x 320 x 150
  - 500 x 320 x 230
  - 750 x 320 x 150
  - 750 x 320 x 230
- Removable glands plates
- Nameplates
- Mounting pan
- Inside pocket for document
- Consult factory for custom drilling, assembly requirements and other ambient temperatures.

## NEC/CEC Certifications and Compliances

- UL Standard: UL 60079-0; 60079-7
- CSA Standard: C22.2 No. 60079-0: 11; 60079-7: 12
- cCSAus Certified: 2625458
- CSA Listed: 013017



**Un-Armored Cable Glands are Supplied as Standard.**  
*Armored Cable Glands are available as an Option.*

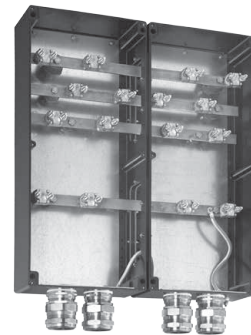

**Sample of 2 x JBEP753215**

## ATEX/IECEX Certifications and Compliances <sup>①</sup>

- Certification Type JBEP
  - Gas, Zones 1 and 2:
    - Conforming to ATEX 94/9/EC: Ⓢ II 2G
    - Conforming to IECEx : EPL Gb
    - Type of Protection: Ex eb IIC
    - Temperature Class: T6 for Ta ≤ +40 °C (+104 °F) and T5 for Ta ≤ +60 °C (+140 °F)
  - Dusts, Zones 21 and 22:
    - Conforming to ATEX: Ⓢ II 2D
    - Conforming to IECEx: EPL Db
    - Type of Protection: Ex tb IIC
    - Surface Temperature : T60 °C (T140 °F) for Ta ≤ +40 °C (+104 °F), T90 °C (+194 °F) for Ta ≤ +60 °C (+140 °F)
- Ambient Temperatures: -55 °C ≤ Ta ≤ +60 °C (-67 °F ≤ Ta ≤ +140 °F)
- ATEX Certificate : LCIE 12 ATEX 3037X
- EC Declaration of Conformity : 50291
- IECEx Certificate : IECEx LCIE 13.0003X
- Index of Protection according EN/IEC 60529: IP66

<sup>①</sup> The ambient temperature for complete assembly is equal to the lowest ambient temperature of the components used.

# ATX™ JBEP Series FRP Terminal Junction Boxes for Electrical and Power Applications

Fiberglass Reinforced Polyester. Increased Safety. Factory Drilled and Equipped.

**NEC/CEC:**  
Class I, Zone 1, AEx e IIC, T5 or T6  
Ex e IIC, T5 or T6  
IP66

**ATEX/IECEx:**  
Zone 1 and 2 – 21 and 22  
II 2 GD  
IP66 – IK10

## Components Ambient Temperature ①

- Type : Bve (plastic close up plug)  
– Ambient Temperatures : -40 °C to +55 °C (-40 °F to +131 °F)
- Type : 757 (nickel plated close up plug)  
– Ambient Temperatures : -60 °C to +100 °C (-40 °F to +212 °F)
- Type : EEXe (plastic cable gland)  
– Ambient Temperatures : -20 °C to +55 °C (-4 °F to +131 °F)
- Type : E1FX, E2FX, E1FW, E2FW, T3, A2F (metal cable gland)  
– Ambient Temperatures : -60 °C to +130 °C (-76 °F to +266 °F)
- Type : PX, PX2K (metal cable gland)  
– Ambient Temperatures : -60 °C to +100 °C (-76 °F to +212 °F)
- Type : DBE (drain/breather)  
– Ambient Temperatures : -50 °C to +85 °C (-58 °F to +185 °F)
- Type : WDU, WFF (terminal)  
– Ambient Temperatures : -50 °C to +120 °C (-58 °F to +248 °F)
- Type : SAK, AKZ (terminal)  
– Ambient Temperatures : -50 °C to +100 °C (-58 °F to +212 °F)

## EURASEC Certification

- Type : JBEP  
– EURASEC N° TC RU C-FR.Г505.B.00911

## Other Certifications

- Type : JBEP  
– INMETRO Certificate: BVC 13.3238-X ②

## Illustrated Features — Sample of JBEP080806NE04T

Description	
1 Screw M5 X 6	
2 JBEP0808060 - Base Holes: 3 x Ø 20.5	
3 Cover Of Polyester Box Type (85 x 85 x 60)	
4 Hood Terminals Compact Set	
8 Nameplate	
9 Gasket Box Type 85 x 85 x 60	
10 Pan Head Screw M4 X 7	
11 Entry Thread Seal M20	
12 Nickel-Plated Brass Locknuts M20 X 1.5	
13 EEx e M20 Cable Gland	
15 Screw M6 X 20 X 10	
16 Hood Term Cover	
17 Earth Plate	

① The ambient temperature for complete assembly is equal to the lowest ambient temperature of the components used.  
② INMETRO certification available on special request only. Contact your local sales representative for more information.

**ATX™ JBEP Series FRP Terminal Junction Boxes for Electrical and Power Applications**

Fiberglass Reinforced Polyester. Increased Safety. Factory Drilled and Equipped.

**NEC/CEC:**  
Class I, Zone 1, AEx e IIC, T5 or T6  
Ex e IIC, T5 or T6  
IP66

**ATEX/IECEx:**  
Zone 1 and 2 – 21 and 22  
II 2 GD  
IP66 – IK10

The Catalog Numbering Guide is a reference tool to explain the make-up of the catalog number. It is not to be used to create a custom product for ordering.

**Catalog Numbering Guide - JBEP Polyester Junction Boxes for Electrical and Power Applications**

<b>JBE</b>	<b>P</b>	<b>08</b>	<b>08</b>	<b>06</b>	<b>A</b>	<b>E</b>	<b>01</b>	<b>T</b>
Series: JBE - NEC/ CEC and ATEX/IECEx Certified Junction Box		Dimensions Height mm (in): 08 - 85 (3.35) 12 - 120 (4.72) 17 - 170 (6.69) 20 - 200 (7.87) 25 - 250 (9.84) 32 - 320 (12.60) 50 - 500 (19.69) 75 - 750 (29.53)		Dimensions Depth mm (in): 06 - 60 (2.36) 09 - 91 (3.58) 09S - 91 (3.58) ① 10 - 95 (3.74) 15 - 150 (5.91) 23 - 230 (9.06)		Options: <i>(Options must be listed alphabetically)</i> E - Electrical: 2.5 mm <sup>2</sup> (14AWG) x 10 mm <sup>2</sup> (6AWG) P - Power: 16 mm <sup>2</sup> (6AWG) to 240 mm <sup>2</sup> (474MCM)		Other Suffix: T - Mantle Clamping (Pillar Terminals)
	Material: P - Polyester		Dimensions Width mm (in): 08 - 85 (3.35) 12 - 120 (4.72) 17 - 170 (6.69) 21 - 215 (8.47) 25 - 250 (9.84) 32 - 320 (12.60) 50 - 500 (19.69) 75 - 750 (29.53)		Cable Type: A - Armored N - Non-Armored		Suffix: 01 to 99 Assigned at Factory	

① 09S Internal dimensions are 0.9 mm (0.035 in) less than the 09 internal dimensions.

# ATX™ JBEP Series FRP Terminal Junction Boxes for Electrical and Power Applications

Fiberglass Reinforced Polyester. Increased Safety. Factory Drilled and Equipped.

Maximum Capacity Per Terminal: 4 x 2.5 mm<sup>2</sup> or 2 x 4 mm<sup>2</sup> + 2 x 2.5 mm<sup>2</sup>; 4 x 6 mm<sup>2</sup> or 3 x 10 mm<sup>2</sup> + 4 mm<sup>2</sup>

**NEC/CEC:**  
Class I, Zone 1, AEx e IIC, T5 or T6  
Ex e IIC, T5 or T6  
IP66

**ATEX/IECEx:**  
Zone 1 and 2 – 21 and 22  
II 2 GD  
IP66 – IK10



JBEP080806NE04T

## Ex eb IIC Factory Drilled JBEP Polyester Junction Boxes Equipped with 4 Live Mantle Clamping (Pillar Terminals) and 1 Earth Terminal Per Way

Maximum capacity per terminal:

- 4 x 2.5 mm<sup>2</sup> or 2 x 4 mm<sup>2</sup> + 2 x 2.5 mm<sup>2</sup>, 550 Volts

Maximum capacity per earth terminal:

- 1 x 4 mm<sup>2</sup>

Rating (Amps):

- 28 Amps for 2.5 mm<sup>2</sup>, 38 Amps for 4 mm<sup>2</sup>

Enclosure Type	Equipment	Entry Layout	Weight kg (lb)	Volume dm <sup>3</sup> (in <sup>3</sup> )	Dimensions – mm (in)	Catalog Number
JBEP0808060	3 x M20 with earth continuity sheet		0.42 (0.93)	0.44 (26.9)	85 x 85 x 61 (3.35 x 3.35 x 2.40)	JBEP080806AE03T
JBEP0808060	3 x M20 with three cable glands for unarmored cable – diameter 6.5 to 14.5 mm (0.26 to 0.57 in)		0.45 (0.99)	0.44 (26.9)	85 x 85 x 61 (3.35 x 3.35 x 2.40)	JBEP080806NE03T
JBEP0808060	4 x M20 with earth continuity sheet		0.43 (0.95)	0.44 (26.9)	85 x 85 x 61 (3.35 x 3.35 x 2.40)	JBEP080806AE04T
JBEP0808060	4 x M20 with four cable glands for unarmored cable – diameter 6.5 to 14.5 mm (0.26 to 0.57 in)		0.48 (1.06)	0.44 (26.9)	85 x 85 x 61 (3.35 x 3.35 x 2.40)	JBEP080806NE04T

## Ex eb IIC Factory Drilled JBEP Polyester Junction Boxes Equipped with 5 Live Mantle Clamping (Pillar Terminals) and 1 Earth Terminal Per Way

Maximum capacity per terminal:

- 4 x 6 mm<sup>2</sup> or 3 x 10 mm<sup>2</sup> + 4 mm<sup>2</sup>, 690 Volts

Maximum capacity per earth terminal:

- 1 x 10 mm<sup>2</sup>

Rating (Amps):

- 28 Amps for 2.5 mm<sup>2</sup>, 38 Amps for 4 mm<sup>2</sup>, 42 Amps for 10 mm<sup>2</sup>

Enclosure Type	Equipment	Entry Layout	Weight kg (lb)	Volume dm <sup>3</sup> (in <sup>3</sup> )	Dimensions – mm (in)	Catalog Number
JBEP121209S0	3 x M20 with earth continuity sheet		0.85 (1.87)	1.31 (80.0)	120 x 120 x 91 (4.72 x 4.72 x 3.58)	JBEP121209AE03T
JBEP121209S0	3 x M25 with three cable glands for unarmored cable – diameter 8 to 17 mm (0.31 to 0.67 in) ⊗		0.9 (1.98)	1.31 (80.0)	120 x 120 x 91 (4.72 x 4.72 x 3.58)	JBEP121209NE13T
JBEP121209S0	4 x M20 with earth continuity sheet		0.88 (1.94)	1.31 (80.0)	120 x 120 x 91 (4.72 x 4.72 x 3.58)	JBEP121209AE04T
JBEP121209S0	4 x M25 with four cable glands for unarmored cable – diameter 8 to 17 mm (0.31 to 0.67 in) ⊗		0.95 (2.09)	1.31 (80.0)	120 x 120 x 91 (4.72 x 4.72 x 3.58)	JBEP121209NE14T

**ATX™ JBEP Series FRP Terminal Junction Boxes for Electrical and Power Applications**

Fiberglass Reinforced Polyester. Increased Safety. Factory Drilled and Equipped.

Maximum Capacity Per Terminal: 4 x 6 mm<sup>2</sup>

**NEC/CEC:**  
 Class I, Zone 1, AEx e IIC, T5 or T6  
 Ex e IIC, T5 or T6  
 IP66

**ATEX/IECEX:**  
 Zone 1 and 2 – 21 and 22  
 II 2 GD  
 IP66 – IK10

**Ex eb IIC Factory Drilled JBEP Polyester Junction Boxes Equipped with 8 Live Mantle Clamping (Pillar Terminals) and 1 Earth Terminal Per Way**

Maximum capacity per terminal:

- 4 x 6 mm<sup>2</sup> or 3 x 10 mm<sup>2</sup> + 4 mm<sup>2</sup>, 690 Volts

Maximum capacity per earth terminal:

- 1 x 10 mm<sup>2</sup>

Rating (Amps):

- 28 Amps for 2.5 mm<sup>2</sup>, 38 Amps for 4 mm<sup>2</sup>, 42 Amps for 10 mm<sup>2</sup>

Enclosure Type	Equipment	Entry Layout	Weight kg (lb)	Volume dm <sup>3</sup> (in <sup>3</sup> )	Dimensions – mm (in)	Catalog Number
JBEP1717090	4 x M20 with earth continuity sheet		1.63 (3.59)	8.91 x 10 <sup>8</sup> (54.3)	170 x 170 x 91 (6.69 x 6.69 x 3.58)	<b>JBEP171709AE04T</b>
JBEP1717090	4 x M20 with three cable glands for unarmored cable – diameter 6.5 to 14.5 mm (0.26 to 0.57 in)		1.55 (3.42)	8.91 x 10 <sup>8</sup> (54.3)	170 x 170 x 91 (6.69 x 6.69 x 3.58)	<b>JBEP171709NE04T</b>
JBEP1717090	6 x M20 with earth continuity sheet		1.55 (3.42)	8.91 x 10 <sup>8</sup> (54.3)	170 x 170 x 91 (6.69 x 6.69 x 3.58)	<b>JBEP171709AE06T</b>
JBEP1717090	6 x M20 with three cable glands for unarmored cable – diameter 6.5 to 14.5 mm (0.26 to 0.57 in)		1.65 (3.64)	8.91 x 10 <sup>8</sup> (54.3)	170 x 170 x 91 (6.69 x 6.69 x 3.58)	<b>JBEP171709NE06T</b>
JBEP1717090	4 x M25 with earth continuity sheet		1.62 (3.57)	8.91 x 10 <sup>8</sup> (54.3)	170 x 170 x 91 (6.69 x 6.69 x 3.58)	<b>JBEP171709AE14T</b>
JBEP1717090	4 x M25 with four cable glands for unarmored cable – diameter 8 to 17 mm (0.31 to 0.67 in)		1.60 (3.53)	8.91 x 10 <sup>8</sup> (54.3)	170 x 170 x 91 (6.69 x 6.69 x 3.58)	<b>JBEP171709NE14T</b>
JBEP1717090	6 x M25 with earth continuity sheet		1.55 (3.42)	8.91 x 10 <sup>8</sup> (54.3)	170 x 170 x 91 (6.69 x 6.69 x 3.58)	<b>JBEP171709AE16T</b>
JBEP1717090	6 x M25 with four cable glands for unarmored cable – diameter 8 to 17 mm (0.31 to 0.67 in)		1.65 (3.64)	8.91 x 10 <sup>8</sup> (54.3)	170 x 170 x 91 (6.69 x 6.69 x 3.58)	<b>JBEP171709NE16T</b>

# ATX™ JBEP Series FRP Terminal Junction Boxes for Electrical and Power Applications

Fiberglass Reinforced Polyester. Increased Safety. Factory Drilled and Equipped.

Maximum Capacity Per Terminal: 2 x 4 mm<sup>2</sup>

NEC/CEC:  
Class I, Zone 1, AEx e IIC, T5 or T6  
Ex e IIC, T5 or T6  
IP66

ATEX/IECEx:  
Zone 1 and 2 – 21 and 22  
II 2 GD  
IP66 – IK10



JBEP080806AE05

## Ex eb IIC Factory Drilled JBEP Polyester Junction Boxes Equipped with 4 Screw Terminals and 2 Earth Terminals

- 2 x 4 mm<sup>2</sup> terminals (MBK3), Rating 24 Amps, 275 Volts  
MBK3/E-Z and MSLKG2.5

Enclosure Type	Equipment	Entry Layout	Weight kg (lb)	Volume dm <sup>3</sup> (in <sup>3</sup> )	Dimensions – mm (in)	Terminal Jumped Catalog Number
<b>Configuration: P + N (1PE + 2L + 2N + 1PE)</b>						
JBEP0808060	3 x M20 with earth continuity device		0.40 (0.88)	0.44 (26.9)	85 x 85 x 61 (3.35 x 3.35 x 2.40)	JBEP080806AE03
JBEP0808060	3 x M20 with four cable glands for unarmored cable – diameter 6.5 to 14.5 mm (0.26 to 0.57 in)		0.42 (0.93)	0.44 (26.9)	85 x 85 x 61 (3.35 x 3.35 x 2.40)	JBEP080806NE03
JBEP0808060	4 x M20 with earth continuity device		0.40 (0.88)	0.44 (26.9)	85 x 85 x 61 (3.35 x 3.35 x 2.40)	JBEP080806AE05
JBEP0808060	4 x M20 with four cable glands for unarmored cable – diameter 6.5 to 14.5 mm (0.26 to 0.57 in)		0.45 (0.99)	0.44 (26.9)	85 x 85 x 61 (3.35 x 3.35 x 2.40)	JBEP080806NE05

## Ex eb IIC Factory Drilled JBEP Polyester Junction Boxes Equipped with 4 Screw Terminals and 2 Earth Terminals

- 2 x 4 mm<sup>2</sup> terminals (MBK3)  
MBK3/E-Z and MSLKG2.5

Enclosure Type	Equipment	Entry Layout	Weight kg (lb)	Volume dm <sup>3</sup> (in <sup>3</sup> )	Dimensions – mm (in)	Catalog Number
<b>Configuration: P + N (1PE + 1 + 2 + 3 + 4 + 1PE)</b>						
JBEP0808060	2 x M20 with earth continuity device, rated Ex eb IIC		0.40 (0.88)	0.44 (26.9)	85 x 85 x 60 (3.35 x 3.35 x 2.36)	JBEP080806AE22
JBEP0808060	2 x M20 with earth continuity device, rated Ex ia IIC		0.45 (0.99)	0.44 (26.9)	85 x 85 x 60 (3.35 x 3.35 x 2.36)	JBEP080806AE23

## Ex eb IIC Factory Drilled JBEP Polyester Junction Boxes Equipped with 6 Screw Terminals and 2 Earth Terminals

- 2 x 4 mm<sup>2</sup> terminals (MBK3), Rating 24 Amps, 275 Volts  
MBK3/E-Z and MSLKG2.5

Enclosure Type	Equipment	Entry Layout	Weight kg (lb)	Volume dm <sup>3</sup> (in <sup>3</sup> )	Dimensions – mm (in)	Catalog Number
<b>Configuration: P + N (1PE + 1 + 2 + 3 + 4 + 5 + 6 + 1PE)</b>						
JBEP0808060	4 x M20 with earth continuity device, rated Ex eb IIC		0.40 (0.88)	0.44 (26.9)	85 x 85 x 60 (3.35 x 3.35 x 2.36)	JBEP080806AE24
JBEP0808060	4 x M20 with earth continuity device, rated Ex ia IIC		0.45 (0.99)	0.44 (26.9)	85 x 85 x 60 (3.35 x 3.35 x 2.36)	JBEP080806AE25

# ATX™ JBEP Series FRP Terminal Junction Boxes for Electrical and Power Applications

Fiberglass Reinforced Polyester. Increased Safety. Factory Drilled and Equipped.

Maximum Capacity Per Terminal: 2 x 4 mm<sup>2</sup>; 2 x 6 mm<sup>2</sup>

NEC/CEC:  
Class I, Zone 1, AEx e IIC, T5 or T6  
Ex e IIC, T5 or T6  
IP66

ATEX/IECEX:  
Zone 1 and 2 – 21 and 22  
II 2 GD  
IP66 – IK10



JBEP121209AE07

## Ex eb IIC Factory Drilled JBEP Polyester Junction Boxes Equipped with 4 Screw Terminals and 2 Earth Terminals

- 2 x 4 mm<sup>2</sup> terminals (WDU4N), Rating 27 Amps, 275 Volts

Enclosure Type	Equipment	Entry Layout	Weight kg (lb)	Volume dm <sup>3</sup> (in <sup>3</sup> )	Dimensions – mm (in)	Terminal Jumped Catalog Number
Configuration: P + N (1PE + 2L + 2N + 1PE)						
JBEP121209S0	4 x M20 with earth continuity device		0.89 (1.96)	1.31 (80.0)	120 x 120 x 91 (4.72 x 4.72 x 3.58)	JBEP121209AE07
JBEP121209S0	4 x M25 with four cable glands for unarmored cable – diameter 8 to 17 mm (0.31 to 0.67 in)		0.93 (2.05)	1.31 (80.0)	120 x 120 x 91 (4.72 x 4.72 x 3.58)	JBEP121209NE08

## Ex eb IIC Factory Drilled JBEP Polyester Junction Boxes Equipped with 4 Screw Terminals and 2 Earth Terminals

- 2 x 6 mm<sup>2</sup> terminals (WDU6), Rating 36 Amps, 550 Volts

Enclosure Type	Equipment	Entry Layout	Weight kg (lb)	Volume dm <sup>3</sup> (in <sup>3</sup> )	Dimensions – mm (in)	Terminal Jumped Catalog Number
Configuration: P + N (1PE + 2L + 2N + 1PE)						
JBEP121209S0	4 x M20 with earth continuity device		1.00 (2.20)	1.31 (80.0)	120 x 120 x 91 (4.72 x 4.72 x 3.58)	JBEP121209AE45
JBEP121209S0	4 x M25 with four cable glands for unarmored cable – diameter 8 to 17 mm (0.31 to 0.67 in)		1.00 (2.20)	1.31 (80.0)	120 x 120 x 91 (4.72 x 4.72 x 3.58)	JBEP121209NE46
JBEP121209S0	4 x M20 with earth continuity device		0.96 (2.12)	1.31 (80.0)	120 x 120 x 91 (4.72 x 4.72 x 3.58)	JBEP121209AE47
JBEP121209S0	4 x M25 with four cable glands for unarmored cable – diameter 8 to 17 mm (0.31 to 0.67 in)		1.00 (2.20)	1.31 (80.0)	120 x 120 x 91 (4.72 x 4.72 x 3.58)	JBEP121209NE48

# ATX™ JBEP Series FRP Terminal Junction Boxes for Electrical and Power Applications

Fiberglass Reinforced Polyester. Increased Safety. Factory Drilled and Equipped.

Maximum Capacity Per Terminal: 2 x 4 mm<sup>2</sup>

NEC/CEC:  
Class I, Zone 1, AEx e IIC, T5 or T6  
Ex e IIC, T5 or T6  
IP66

ATEX/IECEX:  
Zone 1 and 2 – 21 and 22  
II 2 GD  
IP66 – IK10



JBEP121209NE26

## Ex eb IIC Factory Drilled JBEP Polyester Junction Boxes Equipped with 6 Screw Terminals and 2 Earth Terminals

- 2 x 4 mm<sup>2</sup> terminals (MBK3/E-Z and MSLKG2.5), Rating 24 Amps, 275 Volts

Enclosure Type	Equipment	Entry Layout	Weight kg (lb)	Volume dm <sup>3</sup> (in <sup>3</sup> )	Dimensions – mm (in)	Terminal Jumped Catalog Number
<b>Configuration: TP (1PE + 2L1 + 2L2 + 2L3 + 1PE)</b>						
JBEP1212090	4 x M20 with earth continuity device		0.88 (1.94)	1.31 (80.0)	120 x 120 x 91 (4.72 x 4.72 x 3.58)	JBEP121209AE25
JBEP1212090	4 x M25 with four cable glands for unarmored cable – diameter 8 to 17 mm (0.31 to 0.67 in)		0.87 (1.92)	1.31 (80.0)	120 x 120 x 91 (4.72 x 4.72 x 3.58)	JBEP121209NE26
JBEP1212090	4 x M20 with earth continuity device		0.84 (1.85)	1.31 (80.0)	120 x 120 x 91 (4.72 x 4.72 x 3.58)	JBEP121209AE27
JBEP1212090	4 x M25 with four cable glands for unarmored cable – diameter 8 to 17 mm (0.31 to 0.67 in)		0.88 (1.94)	1.31 (80.0)	120 x 120 x 91 (4.72 x 4.72 x 3.58)	JBEP121209NE28

## Ex eb IIC Factory Drilled JBEP Polyester Junction Boxes Equipped with 12 Screw Terminals and 3 Earth Terminals

- 2 x 4 mm<sup>2</sup> terminals (WDU4), Rating 22 Amps, 690 Volts

Enclosure Type	Equipment	Entry Layout	Weight kg (lb)	Volume dm <sup>3</sup> (in <sup>3</sup> )	Dimensions – mm (in)	Terminal Jumped Catalog Number
<b>Configuration: TP + N (1PE + 3L1 + 3L2 + 3L3 + 3N + 2PE)</b>						
JBEP1717090	4 x M25 with earth continuity device		1.54 (3.40)	2.63 (160.49)	170 x 170 x 91 (6.69 x 6.69 x 3.58)	JBEP171709AE46
JBEP1717090	4 x M25 with four cable glands for unarmored cable – diameter 8 to 17 mm (0.31 to 0.67 in)		1.54 (3.40)	2.63 (160.49)	170 x 170 x 91 (6.69 x 6.69 x 3.58)	JBEP171709NE46
JBEP1717090	6 x M20 with earth continuity device		1.54 (3.40)	2.63 (160.49)	170 x 170 x 91 (6.69 x 6.69 x 3.58)	JBEP171709AE47
JBEP1717090	6 x M20 with four cable glands for unarmored cable – diameter 6.5 to 14.5 mm (0.26 to 0.57 in)		1.54 (3.40)	2.63 (160.49)	170 x 170 x 91 (6.69 x 6.69 x 3.58)	JBEP171709NE47
JBEP1717090	6 x M25 with earth continuity device		1.54 (3.40)	2.63 (160.49)	170 x 170 x 91 (6.69 x 6.69 x 3.58)	JBEP171709AE48
JBEP1717090	6 x M25 with four cable glands for unarmored cable – diameter 8 to 17 mm (0.31 to 0.67 in)		1.54 (3.40)	2.63 (160.49)	170 x 170 x 91 (6.69 x 6.69 x 3.58)	JBEP171709NE48



**ATX™ JBEP Series FRP Terminal Junction Boxes for Electrical and Power Applications**

Fiberglass Reinforced Polyester. Increased Safety. Factory Drilled and Equipped.

Maximum Capacity Per Terminal: 6 mm<sup>2</sup>

NEC/CEC:  
Class I, Zone 1, AEx e IIC, T5 or T6  
Ex e IIC, T5 or T6  
IP66

ATEX/IECEX:  
Zone 1 and 2 – 21 and 22  
II 2 GD  
IP66 – IK10

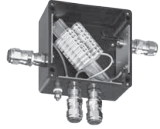

JBEP171709AE06

**Ex eb IIC Factory Drilled JBEP Polyester Junction Boxes Equipped with Screw Terminals and Earth Terminals**

- 6 mm<sup>2</sup> terminals (WDU6) and earth terminals (WPE6), Rating 32 Amps, 550 Volts

Enclosure Type	Equipment	Entry Layout	Weight kg (lb)	Volume dm <sup>3</sup> (in <sup>3</sup> )	Dimensions – mm (in)	Terminal Jumped Catalog Number
<b>Configuration: P + N (1PE + 2L + 2N + 1PE)</b>						
JBEP1717090	3 x M20 with earth continuity device		1.54 (3.40)	2.63 (160.49)	170 x 170 x 91 (6.69 x 6.69 x 3.58)	<b>JBEP171709AE01</b>
JBEP1717090	3 x M25 with three cable glands for unarmored cable – diameter 8 to 17 mm (0.31 to 0.67 in)		1.54 (3.40)	2.63 (160.49)	170 x 170 x 91 (6.69 x 6.69 x 3.58)	<b>JBEP171709NE01</b>
JBEP1717090	4 x M20 with earth continuity device		1.54 (3.40)	2.63 (160.49)	170 x 170 x 91 (6.69 x 6.69 x 3.58)	<b>JBEP171709AE02</b>
JBEP1717090	4 x M25 with four cable glands for unarmored cable – diameter 8 to 17 mm (0.31 to 0.67 in)		1.54 (3.40)	2.63 (160.49)	170 x 170 x 91 (6.69 x 6.69 x 3.58)	<b>JBEP171709NE02</b>
JBEP1717090	4 x M20 with earth continuity device		1.54 (3.40)	2.63 (160.49)	170 x 170 x 91 (6.69 x 6.69 x 3.58)	<b>JBEP171709AE03</b>
JBEP1717090	4 x M25 with four cable glands for unarmored cable – diameter 8 to 17 mm (0.31 to 0.67 in)		1.54 (3.40)	2.63 (160.49)	170 x 170 x 91 (6.69 x 6.69 x 3.58)	<b>JBEP171709NE03</b>
<b>Configuration: P + N (1PE + 3L + 3N + 2PE)</b>						
JBEP1717090	6 x M20 with earth continuity device		1.54 (3.40)	2.63 (160.49)	170 x 170 x 91 (6.69 x 6.69 x 3.58)	<b>JBEP171709AE04</b>
JBEP1717090	6 x M25 with six cable glands for unarmored cable – diameter 8 to 17 mm (0.31 to 0.67 in)		1.54 (3.40)	2.63 (160.49)	170 x 170 x 91 (6.69 x 6.69 x 3.58)	<b>JBEP171709NE04</b>
<b>Configuration: TP (1PE + 2L1 + 2L2 + 2L3 + 1PE)</b>						
JBEP1717090	3 x M20 with earth continuity device		1.54 (3.40)	2.63 (160.49)	170 x 170 x 91 (6.69 x 6.69 x 3.58)	<b>JBEP171709AE05</b>
JBEP1717090	3 x M25 with three cable glands for unarmored cable – diameter 8 to 17 mm (0.31 to 0.67 in)		1.54 (3.40)	2.63 (160.49)	170 x 170 x 91 (6.69 x 6.69 x 3.58)	<b>JBEP171709NE05</b>
JBEP1717090	4 x M20 with earth continuity device		1.54 (3.40)	2.63 (160.49)	170 x 170 x 91 (6.69 x 6.69 x 3.58)	<b>JBEP171709AE06</b>
JBEP1717090	4 x M25 with four cable glands for unarmored cable – diameter 8 to 17 mm (0.31 to 0.67 in)		1.54 (3.40)	2.63 (160.49)	170 x 170 x 91 (6.69 x 6.69 x 3.58)	<b>JBEP171709NE06</b>
JBEP1717090	4 x M20 with earth continuity device		1.54 (3.40)	2.63 (160.49)	170 x 170 x 91 (6.69 x 6.69 x 3.58)	<b>JBEP171709AE07</b>
JBEP1717090	4 x M25 with four cable glands for unarmored cable – diameter 8 to 17 mm (0.31 to 0.67 in)		1.54 (3.40)	2.63 (160.49)	170 x 170 x 91 (6.69 x 6.69 x 3.58)	<b>JBEP171709NE07</b>

# ATX™ JBEP Series FRP Terminal Junction Boxes for Electrical and Power Applications

Fiberglass Reinforced Polyester. Increased Safety. Factory Drilled and Equipped.

Maximum Capacity Per Terminal: 6 mm<sup>2</sup>

NEC/CEC:  
Class I, Zone 1, AEx e IIC, T5 or T6  
Ex e IIC, T5 or T6  
IP66

ATEX/IECEX:  
Zone 1 and 2 – 21 and 22  
II 2 GD  
IP66 – IK10

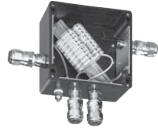

JBEP171709AE10

## Ex eb IIC Factory Drilled JBEP Polyester Junction Boxes Equipped with Screw Terminals and Earth Terminals

- 6 mm<sup>2</sup> terminals (WDU6) and earth terminals (WPE6), Rating 32 Amps, 550 Volts

Enclosure Type	Equipment	Entry Layout	Weight kg (lb)	Volume dm <sup>3</sup> (in <sup>3</sup> )	Dimensions – mm (in)	Terminal Jumped Catalog Number
<b>Configuration: TP (2PE + 3L1 + 3L2 + 3L3 + 1PE)</b>						
JBEP1717090	6 x M20 with earth continuity device		1.54 (3.40)	2.63 (160.49)	170 x 170 x 91 (6.69 x 6.69 x 3.58)	<b>JBEP171709AE08</b>
JBEP1717090	6 x M25 with six cable glands for unarmored cable – diameter 8 to 17 mm (0.31 to 0.67 in)		1.54 (3.40)	2.63 (160.49)	170 x 170 x 91 (6.69 x 6.69 x 3.58)	<b>JBEP171709NE08</b>
<b>Configuration: TP + N (2PE + 2L1 + 2L2 + 2L3 + 2N + 1PE)</b>						
JBEP1717090	3 x M20 with earth continuity device		1.54 (3.40)	2.63 (160.49)	170 x 170 x 91 (6.69 x 6.69 x 3.58)	<b>JBEP171709AE09</b>
JBEP1717090	3 x M25 with three cable glands for unarmored cable – diameter 8 to 17 mm (0.31 to 0.67 in)		1.54 (3.40)	2.63 (160.49)	170 x 170 x 91 (6.69 x 6.69 x 3.58)	<b>JBEP171709NE09</b>
JBEP1717090	4 x M20 with earth continuity device		1.54 (3.40)	2.63 (160.49)	170 x 170 x 91 (6.69 x 6.69 x 3.58)	<b>JBEP171709AE10</b>
JBEP1717090	4 x M25 with four cable glands for unarmored cable – diameter 8 to 17 mm (0.31 to 0.67 in)		1.54 (3.40)	2.63 (160.49)	170 x 170 x 91 (6.69 x 6.69 x 3.58)	<b>JBEP171709NE10</b>
JBEP1717090	4 x M20 with earth continuity device		1.54 (3.40)	2.63 (160.49)	170 x 170 x 91 (6.69 x 6.69 x 3.58)	<b>JBEP171709AE11</b>
JBEP1717090	4 x M25 with four cable glands for unarmored cable – diameter 8 to 17 mm (0.31 to 0.67 in)		1.54 (3.40)	2.63 (160.49)	170 x 170 x 91 (6.69 x 6.69 x 3.58)	<b>JBEP171709NE11</b>
<b>Configuration: TP + N (2PE + 3L1 + 3L2 + 3L3 + 3N + 1PE)</b>						
JBEP2021100	6 x M20 with earth continuity device		2.04 (4.50)	4.09 (249.28)	200 x 215 x 95 (7.87 x 8.46 x 3.74)	<b>JBEP202110AE12</b>
JBEP2021100	6 x M25 with six cable glands for unarmored cable – diameter 8 to 17 mm (0.31 to 0.67 in)		2.04 (4.50)	4.09 (249.28)	200 x 215 x 95 (7.87 x 8.46 x 3.74)	<b>JBEP202110NE12</b>

**ATX™ JBEP Series FRP Terminal Junction Boxes for Electrical and Power Applications**

Fiberglass Reinforced Polyester. Increased Safety. Factory Drilled and Equipped.

Maximum Capacity Per Terminal: 10 mm<sup>2</sup>

NEC/CEC:  
Class I, Zone 1, AEx e IIC, T5 or T6  
Ex e IIC, T5 or T6  
IP66

ATEX/IECEX:  
Zone 1 and 2 – 21 and 22  
II 2 GD  
IP66 – IK10



JBEP171709NE52

**Ex eb IIC Factory Drilled JBEP Polyester Junction Boxes Equipped with Screw Terminals and Earth Terminals**

- 10 mm<sup>2</sup> terminals (WDU10) and earth terminals (WPE10), Rating 50 Amps, 550 Volts

Enclosure Type	Equipment	Entry Layout	Weight kg (lb)	Volume dm <sup>3</sup> (in <sup>3</sup> )	Dimensions – mm (in)	Terminal Jumped Catalog Number
<b>Configuration: P + N (1PE + 2L + 2N + 1PE)</b>						
JBEP1717090	3 x M20 with earth continuity device		2.04 (4.50)	2.63 (160.49)	170 x 170 x 91 (6.69 x 6.69 x 3.58)	<b>JBEP171709AE51</b>
JBEP1717090	3 x M25 with three cable glands for unarmored cable – diameter 8 to 17 mm (0.31 to 0.67 in)		2.04 (4.50)	2.63 (160.49)	170 x 170 x 91 (6.69 x 6.69 x 3.58)	<b>JBEP171709NE51</b>
JBEP1717090	4 x M20 with earth continuity device		2.04 (4.50)	2.63 (160.49)	170 x 170 x 91 (6.69 x 6.69 x 3.58)	<b>JBEP171709AE52</b>
JBEP1717090	4 x M25 with four cable glands for unarmored cable – diameter 8 to 17 mm (0.31 to 0.67 in)		2.04 (4.50)	2.63 (160.49)	170 x 170 x 91 (6.69 x 6.69 x 3.58)	<b>JBEP171709NE52</b>
JBEP1717090	4 x M20 with earth continuity device		2.04 (4.50)	2.63 (160.49)	170 x 170 x 91 (6.69 x 6.69 x 3.58)	<b>JBEP171709AE53</b>
JBEP1717090	4 x M25 with four cable glands for unarmored cable – diameter 8 to 17 mm (0.31 to 0.67 in)		2.04 (4.50)	2.63 (160.49)	170 x 170 x 91 (6.69 x 6.69 x 3.58)	<b>JBEP171709NE53</b>

# ATX™ JBEP Series FRP Terminal Junction Boxes for Electrical and Power Applications

Fiberglass Reinforced Polyester. Increased Safety. Factory Drilled and Equipped.

Maximum Capacity Per Terminal: 10 mm<sup>2</sup>

**NEC/CEC:**  
Class I, Zone 1, AEx e IIC, T5 or T6  
Ex e IIC, T5 or T6  
IP66

**ATEX/IECEX:**  
Zone 1 and 2 – 21 and 22  
II 2 GD  
IP66 – IK10

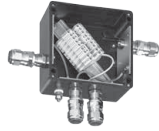

JBEP171709AE57

## Ex eb IIC Factory Drilled JBEP Polyester Junction Boxes Equipped with Screw Terminals and Earth Terminals

- 10 mm<sup>2</sup> terminals (WDU10) and earth terminals (WPE10), Rating 47 Amps, 550 Volts

Enclosure Type	Equipment	Entry Layout	Weight kg (lb)	Volume dm <sup>3</sup> (in <sup>3</sup> )	Dimensions – mm (in)	Terminal Jumped Catalog Number
<b>Configuration: P + N (2PE + 3L + 3N + 1PE)</b>						
JBEP1717090	6 x M20 with earth continuity device		2.04 (4.50)	2.63 (160.49)	170 x 170 x 91 (6.69 x 6.69 x 3.58)	<b>JBEP171709AE54</b>
JBEP1717090	6 x M25 with six cable glands for unarmored cable – diameter 8 to 17 mm (0.31 to 0.67 in)		2.04 (4.50)	2.63 (160.49)	170 x 170 x 91 (6.69 x 6.69 x 3.58)	<b>JBEP171709NE54</b>
<b>Configuration: TP (1PE + 2L1 + 2L2 + 2L3 + 1PE)</b>						
JBEP1717090	3 x M25 with earth continuity device		2.04 (4.50)	2.63 (160.49)	170 x 170 x 91 (6.69 x 6.69 x 3.58)	<b>JBEP171709AE55</b>
JBEP1717090	3 x M25 with three cable glands for unarmored cable – diameter 8 to 17 mm (0.31 to 0.67 in)		2.04 (4.50)	2.63 (160.49)	170 x 170 x 91 (6.69 x 6.69 x 3.58)	<b>JBEP171709NE55</b>
JBEP1717090	4 x M25 with earth continuity device		2.04 (4.50)	2.63 (160.49)	170 x 170 x 91 (6.69 x 6.69 x 3.58)	<b>JBEP171709AE56</b>
JBEP1717090	4 x M25 with four cable glands for unarmored cable – diameter 8 to 17 mm (0.31 to 0.67 in)		2.04 (4.50)	2.63 (160.49)	170 x 170 x 91 (6.69 x 6.69 x 3.58)	<b>JBEP171709NE56</b>
JBEP1717090	4 x M25 with earth continuity device		2.04 (4.50)	2.63 (160.49)	170 x 170 x 91 (6.69 x 6.69 x 3.58)	<b>JBEP171709AE57</b>
JBEP1717090	4 x M25 with four cable glands for unarmored cable – diameter 8 to 17 mm (0.31 to 0.67 in)		2.04 (4.50)	2.63 (160.49)	170 x 170 x 91 (6.69 x 6.69 x 3.58)	<b>JBEP171709NE57</b>

# ATX™ JBEP Series FRP Terminal Junction Boxes for Electrical and Power Applications

Fiberglass Reinforced Polyester. Increased Safety. Factory Drilled and Equipped.

Maximum Capacity Per Terminal: 10 mm<sup>2</sup>

**NEC/CEC:**  
Class I, Zone 1, AEx e IIC, T5 or T6  
Ex e IIC, T5 or T6  
IP66

**ATEX/IECEX:**  
Zone 1 and 2 – 21 and 22  
II 2 GD  
IP66 – IK10

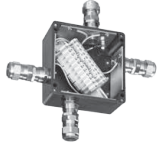

JBEP171709AE61

### Ex eb IIC Factory Drilled JBEP Polyester Junction Boxes Equipped with Screw Terminals and Earth Terminals

- 10 mm<sup>2</sup> terminals (WDU10) and earth terminals (WPE10), Rating 37 Amps, 550 Volts

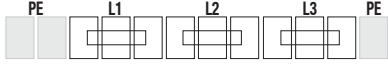
Enclosure Type	Equipment	Entry Layout	Weight kg (lb)	Volume dm <sup>3</sup> (in <sup>3</sup> )	Dimensions – mm (in)	Terminal Jumped Catalog Number
<b>Configuration: TP (2PE + 3L1 + 3L2 + 3L3 + 1PE)</b> 						
JBEP1717090	6 x M25 with earth continuity device		1.60 (3.60)	2.63 (160.49)	170 x 170 x 91 (6.69 x 6.69 x 3.58)	<b>JBEP171709AE58</b>
JBEP1717090	6 x M25 with six cable glands for unarmored cable – diameter 8 to 17 mm (0.31 to 0.67 in)		1.60 (3.60)	2.63 (160.49)	170 x 170 x 91 (6.69 x 6.69 x 3.58)	<b>JBEP171709NE58</b>

### Ex eb IIC Factory Drilled JBEP Polyester Junction Boxes Equipped with Screw Terminals and Earth Terminals

- 10 mm<sup>2</sup> terminals (WDU10) and earth terminals (WPE10), Rating 40 Amps, 550 Volts

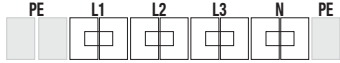
Enclosure Type	Equipment	Entry Layout	Weight kg (lb)	Volume dm <sup>3</sup> (in <sup>3</sup> )	Dimensions – mm (in)	Terminal Jumped Catalog Number
<b>Configuration: TP + N (2PE + 2L1 + 2L2 + 2L3 + 2N + 1PE)</b> 						
JBEP1717090	3 x M25 with earth continuity device		1.60 (3.60)	2.63 (160.49)	170 x 170 x 91 (6.69 x 6.69 x 3.58)	<b>JBEP171709AE59</b>
JBEP1717090	3 x M32 with three cable glands for unarmored cable – diameter 10 to 25 mm (0.39 to 0.98 in)		1.60 (3.60)	2.63 (160.49)	170 x 170 x 91 (6.69 x 6.69 x 3.58)	<b>JBEP171709NE59</b>
JBEP1717090	4 x M25 with earth continuity device		1.60 (3.60)	2.63 (160.49)	170 x 170 x 91 (6.69 x 6.69 x 3.58)	<b>JBEP171709AE60</b>
JBEP1717090	4 x M32 with four cable glands for unarmored cable – diameter 10 to 25 mm (0.39 to 0.98 in)		1.60 (3.60)	2.63 (160.49)	170 x 170 x 91 (6.69 x 6.69 x 3.58)	<b>JBEP171709NE60</b>
JBEP1717090	4 x M25 with earth continuity device		1.60 (3.60)	2.63 (160.49)	170 x 170 x 91 (6.69 x 6.69 x 3.58)	<b>JBEP171709AE61</b>
JBEP1717090	4 x M32 with four cable glands for unarmored cable – diameter 10 to 25 mm (0.39 to 0.98 in)		1.60 (3.60)	2.63 (160.49)	170 x 170 x 91 (6.69 x 6.69 x 3.58)	<b>JBEP171709NE61</b>

# ATX™ JBEP Series FRP Terminal Junction Boxes for Electrical and Power Applications

Fiberglass Reinforced Polyester. Increased Safety. Factory Drilled and Equipped.

Maximum Capacity Per Terminal: 10 mm<sup>2</sup>

**NEC/CEC:**  
Class I, Zone 1, AEx e IIC, T5 or T6  
Ex e IIC, T5 or T6  
IP66

**ATEX/IECEX:**  
Zone 1 and 2 – 21 and 22  
II 2 GD  
IP66 – IK10

## Ex eb IIC Factory Drilled JBEP Polyester Junction Boxes Equipped with Screw Terminals and Earth Terminals

- 10 mm<sup>2</sup> terminals (WDU10) and earth terminals (WPE10), Rating 40 Amps, 550 Volts

Enclosure Type	Equipment	Entry Layout	Weight kg (lb)	Volume dm <sup>3</sup> (in <sup>3</sup> )	Dimensions – mm (in)	Terminal Jumped Catalog Number
<b>Configuration: TP + N (2PE + 3L1 + 3L2 + 3L3 + 3N + 1PE)</b>						
JBEP2021100	6 x M25 with earth continuity device		2.10 (4.60)	4.09 (249.28)	200 x 215 x 95 (7.87 x 8.46 x 3.74)	<b>JBEP202110AE62</b>
JBEP2021100	6 x M32 with six cable glands for unarmored cable – diameter 10 to 25 mm (0.39 to 0.98 in)		2.10 (4.60)	4.09 (249.28)	200 x 215 x 95 (7.87 x 8.46 x 3.74)	<b>JBEP202110NE62</b>

**ATX™ JBEP Series FRP Terminal Junction Boxes for Electrical and Power Applications**

Fiberglass Reinforced Polyester. Increased Safety. Factory Drilled and Equipped.

Maximum Capacity Per Terminal: 16 mm<sup>2</sup>

NEC/CEC:  
Class I, Zone 1, AEx e IIC, T5 or T6  
Ex e IIC, T5 or T6  
IP66

ATEX/IECEx:  
Zone 1 and 2 – 21 and 22  
II 2 GD  
IP66 – IK10



JBEP202115AP06

**Ex eb IIC Factory Drilled JBEP Polyester Junction Boxes Equipped with Screw Terminals, Earth Terminals and Earth Stud**

- 16 mm<sup>2</sup> terminals (WDU16) and earth terminals (WPE16), Rating 60 Amps, 690 Volts

Enclosure Type	Equipment	Entry Layout	Weight kg (lb)	Volume dm <sup>3</sup> (in <sup>3</sup> )	Dimensions – mm (in)	Terminal Jumped Catalog Number
<b>Configuration: P + N (1PE + 2L + 2N + 2PE)</b>						
JBEP2021150	3 x M25 with earth continuity device		4.00 (8.80)	6.45 (393.60)	200 x 215 x 145 (7.87 x 8.46 x 5.71)	<b>JBEP202115AP01</b>
JBEP2021150	3 x M25 with three cable glands for unarmored cable – diameter 8 to 17 mm (0.31 to 0.67 in)		4.00 (8.80)	6.45 (393.60)	200 x 215 x 145 (7.87 x 8.46 x 5.71)	<b>JBEP202115NP01</b>
JBEP2021150	4 x M25 with earth continuity device		4.00 (8.80)	6.45 (393.60)	200 x 215 x 145 (7.87 x 8.46 x 5.71)	<b>JBEP202115AP02</b>
JBEP2021150	4 x M25 with four cable glands for unarmored cable – diameter 8 to 17 mm (0.31 to 0.67 in)		4.00 (8.80)	6.45 (393.60)	200 x 215 x 145 (7.87 x 8.46 x 5.71)	<b>JBEP202115NP02</b>
JBEP2021150	4 x M25 with earth continuity device		4.00 (8.80)	6.45 (393.60)	200 x 215 x 145 (7.87 x 8.46 x 5.71)	<b>JBEP202115AP03</b>
JBEP2021150	4 x M25 with four cable glands for unarmored cable – diameter 8 to 17 mm (0.31 to 0.67 in)		4.00 (8.80)	6.45 (393.60)	200 x 215 x 145 (7.87 x 8.46 x 5.71)	<b>JBEP202115NP03</b>
JBEP2021150	4 x M25 with earth continuity device		4.00 (8.80)	6.45 (393.60)	200 x 215 x 145 (7.87 x 8.46 x 5.71)	<b>JBEP202115AP04</b>
JBEP2021150	4 x M25 with four cable glands for unarmored cable – diameter 8 to 17 mm (0.31 to 0.67 in)		4.00 (8.80)	6.45 (393.60)	200 x 215 x 145 (7.87 x 8.46 x 5.71)	<b>JBEP202115NP04</b>

**Ex eb IIC Factory Drilled JBEP Polyester Junction Boxes Equipped with Screw Terminals, Earth Terminals and Earth Stud**

- 16 mm<sup>2</sup> terminals (WDU16) and earth terminals (WPE16), Rating 55 Amps, 690 Volts

Enclosure Type	Equipment	Entry Layout	Weight kg (lb)	Volume dm <sup>3</sup> (in <sup>3</sup> )	Dimensions – mm (in)	Terminal Jumped Catalog Number
<b>Configuration: P + N (2PE + 3L + 3N + 2PE)</b>						
JBEP2021150	6 x M25 with earth continuity device		4.00 (8.80)	6.45 (393.60)	200 x 215 x 145 (7.87 x 8.46 x 5.71)	<b>JBEP202115AP05</b>
JBEP2021150	6 x M25 with six cable glands for unarmored cable – diameter 8 to 17 mm (0.31 to 0.67 in)		4.00 (8.80)	6.45 (393.60)	200 x 215 x 145 (7.87 x 8.46 x 5.71)	<b>JBEP202115NP05</b>
JBEP2021150	6 x M25 with earth continuity device		4.00 (8.80)	6.45 (393.60)	200 x 215 x 145 (7.87 x 8.46 x 5.71)	<b>JBEP202115AP06</b>
JBEP2021150	6 x M25 with six cable glands for unarmored cable – diameter 8 to 17 mm (0.31 to 0.67 in)		4.00 (8.80)	6.45 (393.60)	200 x 215 x 145 (7.87 x 8.46 x 5.71)	<b>JBEP202115NP06</b>

# ATX™ JBEP Series FRP Terminal Junction Boxes for Electrical and Power Applications

Fiberglass Reinforced Polyester. Increased Safety. Factory Drilled and Equipped.

Maximum Capacity Per Terminal: 16 mm<sup>2</sup>

NEC/CEC:  
Class I, Zone 1, AEx e IIC, T5 or T6  
Ex e IIC, T5 or T6  
IP66

ATEX/IECEx:  
Zone 1 and 2 – 21 and 22  
II 2 GD  
IP66 – IK10



JBEP202115AP12

## Ex eb IIC Factory Drilled JBEP Polyester Junction Boxes Equipped with Screw Terminals, Earth Terminals and Earth Stud

- 16 mm<sup>2</sup> terminals (WDU16) and earth terminals (WPE16), Rating 55 Amps, 690 Volts

Enclosure Type	Equipment	Entry Layout	Weight kg (lb)	Volume dm <sup>3</sup> (in <sup>3</sup> )	Dimensions – mm (in)	Terminal Jumped Catalog Number					
						PE	L1	L2	L3	PE	
<b>Configuration: TP (1PE + 2L1 + 2L2 + 2L3 + 2PE)</b>											
JBEP2021150	3 x M25 with earth continuity device		4.00 (8.80)	6.45 (393.60)	200 x 215 x 145 (7.87 x 8.46 x 5.71)	<b>JBEP202115AP07</b>					
JBEP2021150	3 x M25 with three cable glands for unarmored cable – diameter 8 to 17 mm (0.31 to 0.67 in)		4.00 (8.80)	6.45 (393.60)	200 x 215 x 145 (7.87 x 8.46 x 5.71)	<b>JBEP202115NP07</b>					
JBEP2021150	4 x M25 with earth continuity device		4.00 (8.80)	6.45 (393.60)	200 x 215 x 145 (7.87 x 8.46 x 5.71)	<b>JBEP202115AP08</b>					
JBEP2021150	4 x M25 with four cable glands for unarmored cable – diameter 8 to 17 mm (0.31 to 0.67 in)		4.00 (8.80)	6.45 (393.60)	200 x 215 x 145 (7.87 x 8.46 x 5.71)	<b>JBEP202115NP08</b>					
JBEP2021150	4 x M25 with earth continuity device		4.00 (8.80)	6.45 (393.60)	200 x 215 x 145 (7.87 x 8.46 x 5.71)	<b>JBEP202115AP09</b>					
JBEP2021150	4 x M25 with four cable glands for unarmored cable – diameter 8 to 17 mm (0.31 to 0.67 in)		4.00 (8.80)	6.45 (393.60)	200 x 215 x 145 (7.87 x 8.46 x 5.71)	<b>JBEP202115NP09</b>					
JBEP2021150	4 x M25 with earth continuity device		4.00 (8.80)	6.45 (393.60)	200 x 215 x 145 (7.87 x 8.46 x 5.71)	<b>JBEP202115AP10</b>					
JBEP2021150	4 x M25 with four cable glands for unarmored cable – diameter 8 to 17 mm (0.31 to 0.67 in)		4.00 (8.80)	6.45 (393.60)	200 x 215 x 145 (7.87 x 8.46 x 5.71)	<b>JBEP202115NP10</b>					

## Ex eb IIC Factory Drilled JBEP Polyester Junction Boxes Equipped with Screw Terminals, Earth Terminals and Earth Stud

- 16 mm<sup>2</sup> terminals (WDU16) and earth terminals (WPE16), Rating 43 Amps, 690 Volts

Enclosure Type	Equipment	Entry Layout	Weight kg (lb)	Volume dm <sup>3</sup> (in <sup>3</sup> )	Dimensions – mm (in)	Terminal Jumped Catalog Number					
						PE	L1	L2	L3	PE	
<b>Configuration: TP (2PE + 3L1 + 3L2 + 3L3 + 2PE)</b>											
JBEP2021150	6 x M25 with earth continuity device		4.00 (8.80)	6.45 (393.60)	200 x 215 x 145 (7.87 x 8.46 x 5.71)	<b>JBEP202115AP11</b>					
JBEP2021150	6 x M25 with six cable glands for unarmored cable – diameter 8 to 17 mm (0.31 to 0.67 in)		4.00 (8.80)	6.45 (393.60)	200 x 215 x 145 (7.87 x 8.46 x 5.71)	<b>JBEP202115NP11</b>					
JBEP2021150	6 x M25 with earth continuity device		4.00 (8.80)	6.45 (393.60)	200 x 215 x 145 (7.87 x 8.46 x 5.71)	<b>JBEP202115AP12</b>					
JBEP2021150	6 x M25 with six cable glands for unarmored cable – diameter 8 to 17 mm (0.31 to 0.67 in)		4.00 (8.80)	6.45 (393.60)	200 x 215 x 145 (7.87 x 8.46 x 5.71)	<b>JBEP202115NP12</b>					



# ATX™ JBEP Series FRP Terminal Junction Boxes for Electrical and Power Applications

Fiberglass Reinforced Polyester. Increased Safety. Factory Drilled and Equipped.

Maximum Capacity Per Terminal: 16 mm<sup>2</sup>

**NEC/CEC:**  
Class I, Zone 1, AEx e IIC, T5 or T6  
Ex e IIC, T5 or T6  
IP66

**ATEX/IEC:**  
Zone 1 and 2 – 21 and 22  
II 2 GD  
IP66 – IK10

## Ex eb IIC Factory Drilled JBEP Polyester Junction Boxes Equipped with Screw Terminals, Earth Terminals and Earth Stud

- 16 mm<sup>2</sup> terminals (WDU16) and earth terminals (WPE16), Rating 45 Amps, 690 Volts

Enclosure Type	Equipment	Entry Layout	Weight kg (lb)	Volume dm <sup>3</sup> (in <sup>3</sup> )	Dimensions – mm (in)	Terminal Jumped
						Catalog Number
<b>Configuration: TP + N (2PE + 2L1 + 2L2 + 2L3 + 2N + PE)</b>						
JBEP2021150	3 x M25 with earth continuity device		4.00 (8.80)	6.45 (393.60)	200 x 215 x 145 (7.87 x 8.46 x 5.71)	<b>JBEP202115AP13</b>
JBEP2021150	3 x M32 with three cable glands for unarmored cable – diameter 10 to 25 mm (0.39 to 0.98 in)		4.00 (8.80)	6.45 (393.60)	200 x 215 x 145 (7.87 x 8.46 x 5.71)	<b>JBEP202115NP13</b>
JBEP2021150	4 x M25 with earth continuity device		4.00 (8.80)	6.45 (393.60)	200 x 215 x 145 (7.87 x 8.46 x 5.71)	<b>JBEP202115AP14</b>
JBEP2021150	4 x M32 with four cable glands for unarmored cable – diameter 10 to 25 mm (0.39 to 0.98 in)		4.00 (8.80)	6.45 (393.60)	200 x 215 x 145 (7.87 x 8.46 x 5.71)	<b>JBEP202115NP14</b>
JBEP2021150	4 x M25 with earth continuity device		4.00 (8.80)	6.45 (393.60)	200 x 215 x 145 (7.87 x 8.46 x 5.71)	<b>JBEP202115AP15</b>
JBEP2021150	4 x M32 with four cable glands for unarmored cable – diameter 10 to 25 mm (0.39 to 0.98 in)		4.00 (8.80)	6.45 (393.60)	200 x 215 x 145 (7.87 x 8.46 x 5.71)	<b>JBEP202115NP15</b>
JBEP2021150	4 x M25 with earth continuity device		4.00 (8.80)	6.45 (393.60)	200 x 215 x 145 (7.87 x 8.46 x 5.71)	<b>JBEP202115AP16</b>
JBEP2021150	4 x M32 with four cable glands for unarmored cable – diameter 10 to 25 mm (0.39 to 0.98 in)		4.00 (8.80)	6.45 (393.60)	200 x 215 x 145 (7.87 x 8.46 x 5.71)	<b>JBEP202115NP16</b>

## Ex eb IIC Factory Drilled JBEP Polyester Junction Boxes Equipped with Screw Terminals, Earth Terminals and Earth Stud

- 16 mm<sup>2</sup> terminals (WDU16) and earth terminals (WPE16), Rating 40 Amps, 690 Volts

Enclosure Type	Equipment	Entry Layout	Weight kg (lb)	Volume dm <sup>3</sup> (in <sup>3</sup> )	Dimensions – mm (in)	Terminal Jumped
						Catalog Number
<b>Configuration: TP + N (2PE + 3L1 + 3L2 + 3L3 + 3N + 2PE)</b>						
JBEP2532150	6 x M25 with earth continuity device		8.20 (18.00)	12.00 (732.28)	250 x 320 x 150 (9.84 x 12.60 x 5.94)	<b>JBEP253215AP17</b>
JBEP2532150	6 x M32 with six cable glands for unarmored cable – diameter 10 to 25 mm (0.39 to 0.98 in)		8.20 (18.00)	12.00 (732.28)	250 x 320 x 150 (9.84 x 12.60 x 5.94)	<b>JBEP253215NP17</b>
JBEP2532150	6 x M25 with earth continuity device		8.20 (18.00)	12.00 (732.28)	250 x 320 x 150 (9.84 x 12.60 x 5.94)	<b>JBEP253215AP18</b>
JBEP2532150	6 x M32 with six cable glands for unarmored cable – diameter 10 to 25 mm (0.39 to 0.98 in)		8.20 (18.00)	12.00 (732.28)	250 x 320 x 150 (9.84 x 12.60 x 5.94)	<b>JBEP253215NP18</b>

# ATX™ JBEP Series FRP Terminal Junction Boxes for Electrical and Power Applications

Fiberglass Reinforced Polyester. Increased Safety. Factory Drilled and Equipped.

Maximum Capacity Per Terminal: 25/35 mm<sup>2</sup>

**NEC/CEC:**  
Class I, Zone 1, AEx e IIC, T5 or T6  
Ex e IIC, T5 or T6  
IP66

**ATEX/IECEX:**  
Zone 1 and 2 – 21 and 22  
II 2 GD  
IP66 – IK10



JBEP253215NP02

## Ex eb IIC Factory Drilled JBEP Polyester Junction Boxes Equipped with Screw Terminals, Earth Terminals and Earth Stud

- 25 mm<sup>2</sup> terminals (WDU35) and earth terminals (WPE35), Rating 80 Amps, 690 Volts
- 35 mm<sup>2</sup> terminals (WDU35) and earth terminals (WPE35), Rating 98 Amps, 690 Volts

Enclosure Type	Equipment	Entry Layout	Weight kg (lb)	Volume dm <sup>3</sup> (in <sup>3</sup> )	Dimensions – mm (in)	Terminal Jumped Catalog Number
<b>Configuration: TP (1PE + 2L1 + 2L2 + 2L3 + 2PE)</b>						
JBEP2532150	4 x M32 with earth continuity device		8.20 (18.00)	12.00 (732.28)	250 x 320 x 151 (9.84 x 12.60 x 5.94)	<b>JBEP253215AP01</b>
JBEP2532150	4 x M32 with four cable glands for unarmored cable – diameter 10 to 25 mm (0.39 to 0.98 in)		8.20 (18.00)	12.00 (732.28)	250 x 320 x 151 (9.84 x 12.60 x 5.94)	<b>JBEP253215NP01</b>

## Ex eb IIC Factory Drilled JBEP Polyester Junction Boxes Equipped with Screw Terminals, Earth Terminals and Earth Stud

- 25 mm<sup>2</sup> terminals (WDU35) and earth terminals (WPE35), Rating 70 Amps, 690 Volts
- 35 mm<sup>2</sup> terminals (WDU35) and earth terminals (WPE35), Rating 80 Amps, 690 Volts

Enclosure Type	Equipment	Entry Layout	Weight kg (lb)	Volume dm <sup>3</sup> (in <sup>3</sup> )	Dimensions – mm (in)	Terminal Jumped Catalog Number
<b>Configuration: TP (2PE + 3L1 + 3L2 + 3L3 + 2PE)</b>						
JBEP2532150	6 x M32 with earth continuity device		8.20 (18.00)	12.00 (732.28)	250 x 320 x 151 (9.84 x 12.60 x 5.94)	<b>JBEP253215AP02</b>
JBEP2532150	6 x M32 with six cable glands for unarmored cable – diameter 10 to 25 mm (0.39 to 0.98 in)		8.20 (18.00)	12.00 (732.28)	250 x 320 x 151 (9.84 x 12.60 x 5.94)	<b>JBEP253215NP02</b>

# ATX™ JBEP Series FRP Terminal Junction Boxes for Electrical and Power Applications

Fiberglass Reinforced Polyester. Increased Safety. Factory Drilled and Equipped.

Maximum Capacity Per Terminal: 25/35 mm<sup>2</sup>

NEC/CEC:  
Class I, Zone 1, AEx e IIC, T5 or T6  
Ex e IIC, T5 or T6  
IP66

ATEX/IECEx:  
Zone 1 and 2 – 21 and 22  
II 2 GD  
IP66 – IK10



JBEP253215NP04

## Ex eb IIC Factory Drilled JBEP Polyester Junction Boxes Equipped with Screw Terminals, Earth Terminals and Earth Stud

- 25 mm<sup>2</sup> terminals (WDU35) and earth terminals (WPE35), Rating 75 Amps, 690 Volts
- 35 mm<sup>2</sup> terminals (WDU35) and earth terminals (WPE35), Rating 85 Amps, 690 Volts

Enclosure Type	Equipment	Entry Layout	Weight kg (lb)	Volume dm <sup>3</sup> (in <sup>3</sup> )	Dimensions – mm (in)	Terminal Jumped Catalog Number
<b>Configuration: TP + N (2PE + 2L1 + 2L2 + 2L3 + 2N + PE)</b>						
JBEP2532150	4 x M32 with earth continuity device		8.20 (18.00)	12.00 (732.28)	250 x 320 x 150 (9.84 x 12.60 x 5.91)	<b>JBEP253215AP03</b>
JBEP2532150	4 x M32 with four cable glands for unarmored cable – diameter 10 to 25 mm (0.39 to 0.98 in)		8.20 (18.00)	12.00 (732.28)	250 x 320 x 150 (9.84 x 12.60 x 5.91)	<b>JBEP253215NP03</b>

## Ex eb IIC Factory Drilled JBEP Polyester Junction Boxes Equipped with Screw Terminals, Earth Terminals and Earth Stud

- 25 mm<sup>2</sup> terminals (WDU35) and earth terminals (WPE35), Rating 58 Amps, 690 Volts
- 35 mm<sup>2</sup> terminals (WDU35) and earth terminals (WPE35), Rating 68 Amps, 690 Volts

Enclosure Type	Equipment	Entry Layout	Weight kg (lb)	Volume dm <sup>3</sup> (in <sup>3</sup> )	Dimensions – mm (in)	Terminal Jumped Catalog Number
<b>Configuration: TP + N (2PE + 3L1 + 3L2 + 3L3 + 3N + 2PE)</b>						
JBEP2532150	6 x M32 with earth continuity device		8.20 (18.00)	12.00 (732.28)	250 x 320 x 150 (9.84 x 12.60 x 5.91)	<b>JBEP253215AP04</b>
JBEP2532150	6 x M40 with six cable glands for unarmored cable – diameter 24 to 34 mm (0.94 to 1.34 in)		8.20 (18.00)	12.00 (732.28)	250 x 320 x 150 (9.84 x 12.60 x 5.91)	<b>JBEP253215NP04</b>

# ATX™ JBEP Series FRP Terminal Junction Boxes for Electrical and Power Applications

Fiberglass Reinforced Polyester. Increased Safety. Factory Drilled and Equipped.

Maximum Capacity Per Terminal: 10 mm<sup>2</sup> to 50 mm<sup>2</sup>

**NEC/CEC:**  
Class I, Zone 1, AEx e IIC, T5 or T6  
Ex e IIC, T5 or T6  
IP66

**ATEX/IECEX:**  
Zone 1 and 2 – 21 and 22  
II 2 GD  
IP66 – IK10



JBEP503215AP02

## Ex eb IIC Factory Drilled JBEP Polyester Junction Boxes Equipped with Screw Terminals, Earth Terminals and Earth Stud

- 10 mm<sup>2</sup> to 50 mm<sup>2</sup> terminals (WDU50N) and earth terminals (WPE35), Rating 125 Amps, 550 Volts

Enclosure Type	Equipment	Entry Layout	Weight kg (lb)	Volume dm <sup>3</sup> (in <sup>3</sup> )	Dimensions – mm (in)	Terminal Jumped Catalog Number
<b>Configuration: TP (1PE + 2L1 + 2L2 + 2L3 + 2PE)</b>						
JBEP5032150	4 x M40 with earth continuity device		8.50 (18.60)	24.00 (1464.57)	500 x 320 x 150 (19.68 x 12.60 x 5.91)	<b>JBEP503215AP01</b>
JBEP5032150	4 x M40 with four cable glands for unarmored cable – diameter 24 to 34 mm (0.94 to 1.34 in)		8.50 (18.60)	24.00 (1464.57)	500 x 320 x 150 (19.68 x 12.60 x 5.91)	<b>JBEP503215NP01</b>

## Ex eb IIC Factory Drilled JBEP Polyester Junction Boxes Equipped with Screw Terminals, Earth Terminals and Earth Stud

- 10 mm<sup>2</sup> to 50 mm<sup>2</sup> terminals (WDU50N) and earth terminals (WPE35), Rating 125 Amps, 550 Volts

Enclosure Type	Equipment	Entry Layout	Weight kg (lb)	Volume dm <sup>3</sup> (in <sup>3</sup> )	Dimensions – mm (in)	Terminal Jumped Catalog Number
<b>Configuration: TP (2PE + 3L1 + 3L2 + 3L3 + 2PE)</b>						
JBEP5032150	6 x M40 with earth continuity device		8.50 (18.60)	24.00 (1464.57)	500 x 320 x 150 (19.68 x 12.60 x 5.91)	<b>JBEP503215AP02</b>
JBEP5032150	6 x M40 with six cable glands for unarmored cable – diameter 24 to 34 mm (0.94 to 1.34 in)		8.50 (18.60)	24.00 (1464.57)	500 x 320 x 150 (19.68 x 12.60 x 5.91)	<b>JBEP503215NP02</b>

# ATX™ JBEP Series FRP Terminal Junction Boxes for Electrical and Power Applications

Fiberglass Reinforced Polyester. Increased Safety. Factory Drilled and Equipped.

Maximum Capacity Per Terminal: 10 mm<sup>2</sup> to 50 mm<sup>2</sup>

**NEC/CEC:**  
Class I, Zone 1, AEx e IIC, T5 or T6  
Ex e IIC, T5 or T6  
IP66

**ATEX/IECEX:**  
Zone 1 and 2 – 21 and 22  
II 2 GD  
IP66 – IK10



JBEP503215AP04

### Ex eb IIC Factory Drilled JBEP Polyester Junction Boxes Equipped with Screw Terminals, Earth Terminals and Earth Stud

- 10 mm<sup>2</sup> to 50 mm<sup>2</sup> terminals (WDU50N) and earth terminals (WPE35), Rating 125 Amps, 550 Volts

Enclosure Type	Equipment	Entry Layout	Weight kg (lb)	Volume dm <sup>3</sup> (in <sup>3</sup> )	Dimensions – mm (in)	Terminal Jumped Catalog Number
<b>Configuration: TP + N (2PE + 2L1 + 2L2 + 2L3 + 2N + PE)</b>						
JBEP5032150	4 x M40 with earth continuity device		8.50 (18.60)	24.00 (1464.57)	500 x 320 x 150 (19.68 x 12.60 x 5.91)	<b>JBEP503215AP03</b>
JBEP5032150	4 x M40 with four cable glands for unarmored cable – diameter 24 to 34 mm (0.94 to 1.34 in)		8.50 (18.60)	24.00 (1464.57)	500 x 320 x 150 (19.68 x 12.60 x 5.91)	<b>JBEP503215NP03</b>

### Ex eb IIC Factory Drilled JBEP Polyester Junction Boxes Equipped with Screw Terminals, Earth Terminals and Earth Stud

- 10 mm<sup>2</sup> to 50 mm<sup>2</sup> terminals (WDU50N) and earth terminals (WPE35), Rating 100 Amps, 550 Volts

Enclosure Type	Equipment	Entry Layout	Weight kg (lb)	Volume dm <sup>3</sup> (in <sup>3</sup> )	Dimensions – mm (in)	Terminal Jumped Catalog Number
<b>Configuration: TP + N (2PE + 3L1 + 3L2 + 3L3 + 3N + 2PE)</b>						
JBEP5032150	6 x M40 with earth continuity device		9.30 (20.50)	24.00 (1464.57)	500 x 320 x 150 (19.68 x 12.60 x 5.91)	<b>JBEP503215AP04</b>
JBEP5032230	6 x M50 with six cable glands for unarmored cable – diameter 28 to 42 mm (1.10 to 1.65 in)		10.30 (22.70)	36.80 (2245.67)	500 x 320 x 230 (19.68 x 12.60 x 9.06)	<b>JBEP503223NP04</b>

# ATX™ JBEP Series FRP Terminal Junction Boxes for Electrical and Power Applications

Fiberglass Reinforced Polyester. Increased Safety. Factory Drilled and Equipped.

Maximum Capacity Per Terminal: 10 mm<sup>2</sup> to 70 mm<sup>2</sup>

**NEC/CEC:**  
Class I, Zone 1, AEx e IIC, T5 or T6  
Ex e IIC, T5 or T6  
IP66

**ATEX/IECEX:**  
Zone 1 and 2 – 21 and 22  
Ⓢ II 2 GD  
IP66 – IK10



JBEP503215AP22

## Ex eb IIC Factory Drilled JBEP Polyester Junction Boxes Equipped with Screw Terminals, Earth Terminals and Earth Stud

- 10 mm<sup>2</sup> to 70 mm<sup>2</sup> terminals (WDU70N) and earth terminals (WPE35), Rating 160 Amps, 550 Volts

Enclosure Type	Equipment	Entry Layout	Weight kg (lb)	Volume dm <sup>3</sup> (in <sup>3</sup> )	Dimensions – mm (in)	Terminal Jumped Catalog Number
<b>Configuration: TP (1PE + 2L1 + 2L2 + 2L3 + 2PE)</b>						
JBEP5032150	4 x M40 with earth continuity device		9.30 (20.50)	24.00 (1464.57)	500 x 320 x 150 (19.68 x 12.60 x 5.91)	<b>JBEP503215AP21</b>
JBEP5032150	4 x M40 with four cable glands for unarmored cable – diameter 24 to 34 mm (0.94 to 1.34 in)		9.30 (20.50)	24.00 (1464.57)	500 x 320 x 150 (19.68 x 12.60 x 5.91)	<b>JBEP503215NP21</b>

## Ex eb IIC Factory Drilled JBEP Polyester Junction Boxes Equipped with Screw Terminals, Earth Terminals and Earth Stud

- 10 mm<sup>2</sup> to 70 mm<sup>2</sup> terminals (WDU70N) and earth terminals (WPE35), Rating 140 Amps, 550 Volts

Enclosure Type	Equipment	Entry Layout	Weight kg (lb)	Volume dm <sup>3</sup> (in <sup>3</sup> )	Dimensions – mm (in)	Terminal Jumped Catalog Number ②
<b>Configuration: TP (2PE + 3L1 + 3L2 + 3L3 + 2PE)</b>						
JBEP5032150	6 x M40 with earth continuity device		9.30 (20.50)	24.00 (1464.57)	500 x 320 x 150 (19.68 x 12.60 x 5.91)	<b>JBEP503215AP22</b>
JBEP5032150	6 x M40 with six cable glands for unarmored cable – diameter 24 to 34 mm (0.94 to 1.34 in)		9.30 (20.50)	24.00 (1464.57)	500 x 320 x 150 (19.68 x 12.60 x 5.91)	<b>JBEP503215NP22</b>

**ATX™ JBEP Series FRP Terminal Junction Boxes for Electrical and Power Applications**

Fiberglass Reinforced Polyester. Increased Safety. Factory Drilled and Equipped.

Maximum Capacity Per Terminal: 10 mm<sup>2</sup> to 70 mm<sup>2</sup>

NEC/CEC:  
Class I, Zone 1, AEx e IIC, T5 or T6  
Ex e IIC, T5 or T6  
IP66

ATEX/IECEX:  
Zone 1 and 2 – 21 and 22  
II 2 GD  
IP66 – IK10



JBEP503215AP24

**Ex eb IIC Factory Drilled JBEP Polyester Junction Boxes Equipped with Screw Terminals, Earth Terminals and Earth Stud**

- 10 mm<sup>2</sup> to 70 mm<sup>2</sup> terminals (WDU70N) and earth terminals (WPE35), Rating 150 Amps, 550 Volts

Enclosure Type	Equipment	Entry Layout	Weight kg (lb)	Volume dm <sup>3</sup> (in <sup>3</sup> )	Dimensions – mm (in)	Terminal Jumped Catalog Number ②
<b>Configuration: TP + N (2PE + 2L1 + 2L2 + 2L3 + 2N + PE)</b>						
JBEP5032150	4 x M40 with earth continuity device		9.30 (20.50)	24.00 (1464.57)	500 x 320 x 150 (19.68 x 12.60 x 5.91)	<b>JBEP503215AP23</b>
JBEP5032150	4 x M40 with four cable glands for unarmored cable – diameter 24 to 34 mm (0.94 to 1.34 in)		9.30 (20.50)	24.00 (1464.57)	500 x 320 x 150 (19.68 x 12.60 x 5.91)	<b>JBEP503215NP23</b>

**Ex eb IIC Factory Drilled JBEP Polyester Junction Boxes Equipped with Screw Terminals, Earth Terminals and Earth Stud**

- 10 mm<sup>2</sup> to 70 mm<sup>2</sup> terminals (WDU70N) and earth terminals (WPE35), Rating 125 Amps, 550 Volts

Enclosure Type	Equipment	Entry Layout	Weight kg (lb)	Volume dm <sup>3</sup> (in <sup>3</sup> )	Dimensions – mm (in)	Terminal Jumped Catalog Number
<b>Configuration: TP + N (2PE + 3L1 + 3L2 + 3L3 + 3N + 2PE)</b>						
JBEP5032150	6 x M40 with earth continuity device		9.30 (20.50)	24.00 (1464.57)	500 x 320 x 150 (19.68 x 12.60 x 5.91)	<b>JBEP503215AP24</b>
JBEP5032230	6 x M50 with six cable glands for unarmored cable – diameter 28 to 42 mm (1.10 to 1.65 in)		10.30 (22.70)	36.80 (2245.67)	500 x 320 x 230 (19.68 x 12.60 x 9.06)	<b>JBEP503223NP24</b>

# ATX™ JBEP Series FRP Terminal Junction Boxes for Electrical and Power Applications

Fiberglass Reinforced Polyester. Increased Safety. Factory Drilled and Equipped.







Maximum Capacity Per Terminal: 120 mm<sup>2</sup>

**NEC/CEC:**  
Class I, Zone 1, AEx e IIC, T5 or T6  
Ex e IIC, T5 or T6  
IP66

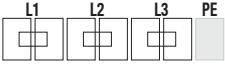
**ATEX/IECEX:**  
Zone 1 and 2 – 21 and 22  
II 2 GD  
IP66 – IK10

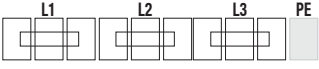
## Ex eb IIC Factory Drilled JBEP Polyester Junction Boxes Equipped with Screw Terminals, Earth Bar and Earth Stud

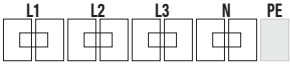
- 10 mm<sup>2</sup> to 120 mm<sup>2</sup> terminals (WDU95N/120N) and earth copper bar, Rating 200 Amps, 690 Volts

Enclosure Type	Equipment	Entry Layout	Weight kg (lb)	Volume dm <sup>3</sup> (in <sup>3</sup> )	Dimensions – mm (in)	Terminal Jumped Catalog Number
						
<b>Configuration: TP (2L1 + 2L2 + 2L3 + 1PE)</b>						
JBEP7532230	4 x M50 with earth continuity device		10.80 (23.80)	55.20 (3368.51)	750 x 320 x 230 (29.53 x 12.60 x 9.06)	<b>JBEP753223AP01</b>
JBEP7532150	4 x M50 with four cable glands for unarmored cable – diameter 28 to 42 mm (1.10 to 1.65 in)		9.75 (21.50)	36.00 (2196.85)	750 x 320 x 150 (29.53 x 12.60 x 5.91)	<b>JBEP753215NP01</b>
						
<b>Configuration: TP (3L1 + 3L2 + 3L3 + 1PE)</b>						
JBEP7532230	6 x M50 with earth continuity device		10.80 (23.80)	55.20 (3368.51)	750 x 320 x 230 (29.53 x 12.60 x 9.06)	<b>JBEP753223AP02</b>
JBEP7532230	6 x M50 with six cable glands for unarmored cable – diameter 28 to 42 mm (1.10 to 1.65 in)		10.80 (23.80)	55.20 (3368.51)	750 x 320 x 230 (29.53 x 12.60 x 9.06)	<b>JBEP753223NP02</b>
						
<b>Configuration: TP + N (2L1 + 2L2 + 2L3 + 2N + 1PE)</b>						
JBEP7532230	4 x M50 with earth continuity device		10.80 (23.80)	55.20 (3368.51)	750 x 320 x 230 (29.53 x 12.60 x 9.06)	<b>JBEP753223AP03</b>
JBEP7532150	4 x M50 with four cable glands for unarmored cable – diameter 28 to 42 mm (1.10 to 1.65 in)		9.75 (21.50)	36.00 (2196.85)	750 x 320 x 150 (29.53 x 12.60 x 5.91)	<b>JBEP753215NP03</b>



# ATX™ JBEP Series FRP Terminal Junction Boxes for Electrical and Power Applications

Fiberglass Reinforced Polyester. Increased Safety. Factory Drilled and Equipped.

Maximum Capacity Per Terminal: 240 mm<sup>2</sup>

**NEC/CEC:**  
Class I, Zone 1, AEx e IIC, T5 or T6  
Ex e IIC, T5 or T6  
IP66

**ATEX/IECEX:**  
Zone 1 and 2 – 21 and 22  
II 2 GD  
IP66 – IK10

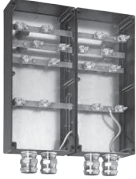

JBEP753215AP72

### Ex eb IIC Factory Drilled JBEP Polyester Junction Boxes Equipped with Clamping Terminals and Earth Stud

- 35/240 mm<sup>2</sup> clamping terminals on a bus bar and earth terminal (Earth Bus), Rating 400 Amps, 1100 Volts

Enclosure Type	Equipment	Entry Layout	Weight kg (lb)	Volume dm <sup>3</sup> (in <sup>3</sup> )	Dimensions – mm (in)	Standard Bus Bar Catalog Number
<div style="display: flex; justify-content: space-between; align-items: center;"> <div> <p><b>Configuration: (L1 + L2 + L3 + PE All Copper Bars)</b></p> </div> <div style="text-align: right;"> </div> </div>						
2 x JBEP7532150	3 x M50 with earth continuity device, 3 Clamping terminals per bar		40.50 (89.30)	73.13 (4462.36)	750 x 650 x 150 (29.53 x 25.59 x 5.91)	JBEP753215AP61
2 x JBEP7532150	4 x M50 with earth continuity device, 4 Clamping terminals per bar		40.50 (89.30)	73.13 (4462.36)	750 x 650 x 150 (29.53 x 25.59 x 5.91)	JBEP753215AP62
2 x JBEP7532150	3 x M63 with earth continuity device, 3 Clamping terminals per bar		40.50 (89.30)	73.13 (4462.36)	750 x 650 x 150 (29.53 x 25.59 x 5.91)	JBEP753215AP71
2 x JBEP7532150	4 x M63 with earth continuity device, 4 Clamping terminals per bar		40.50 (89.30)	73.13 (4462.36)	750 x 650 x 150 (29.53 x 25.59 x 5.91)	JBEP753215AP72

### Example of Two JBEP753215 Enclosures Coupled

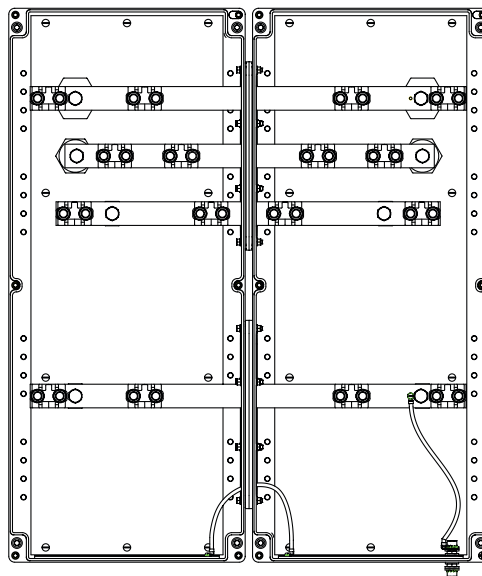

# ATX™ JBEP Series FRP Terminal Junction Boxes for Electrical and Power Applications

Fiberglass Reinforced Polyester. Increased Safety. Factory Drilled and Equipped.

NEC/CEC:  
Class I, Zone 1, AEx e IIC, T5 or T6  
Ex e IIC, T5 or T6  
IP66

ATEX/IECEX:  
Zone 1 and 2 – 21 and 22  
II 2 GD  
IP66 – IK10

Dimensions in Millimeters (Inches) ①

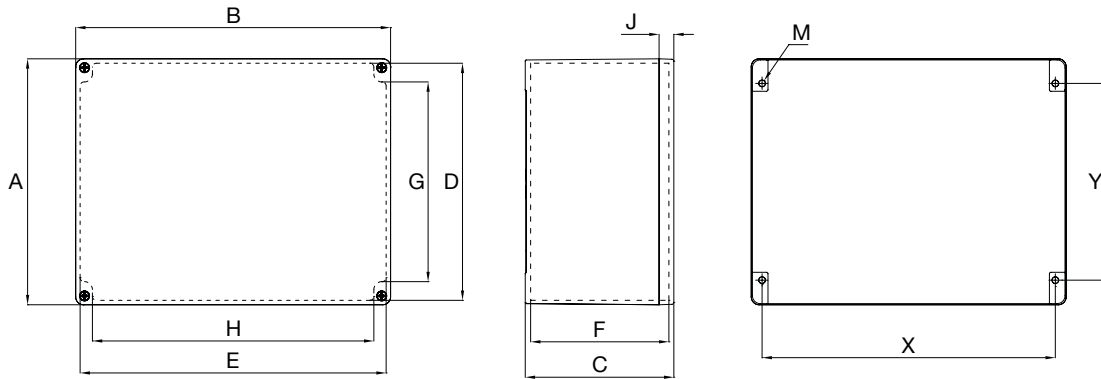

Enclosure Catalog Number	External Dimension				Internal Dimensions				Cover J	Body Thickness	Wall Fixing		M ②
	A	B	C	D	E	F	G	H			X	Y	
JBEP0808060	85.0 (3.346)	85.0 (3.346)	61.0 (2.402)	76.7 (3.020)	76.7 (3.020)	47.0 (1.850)	41.0 (1.614)	51.0 (2.008)	15.0 (0.591)	3.5 (0.138)	69.0 (2.717)	49.0 (1.929)	M4
JBEP1212090	120.0 (4.724)	120.0 (4.724)	91.0 (3.583)	109.5 (4.311)	109.5 (4.311)	75.0 (2.953)	63.0 (4.528)	85.0 (3.346)	40.0 (1.575)	4.5 (0.177)	103.0 (4.055)	83.0 (3.268)	M5
JBEP121209S0	120.0 (4.724)	120.0 (4.724)	91.0 (3.583)	108.6 (4.276)	108.6 (4.276)	75.0 (2.953)	63.0 (4.528)	85.0 (3.346)	15.0 (0.591)	4.5 (0.177)	103.0 (4.055)	83.0 (3.268)	M5
JBEP1717090	170.0 (6.693)	170.0 (6.693)	91.0 (3.583)	158.5 (6.240)	158.5 (6.240)	72.0 (2.835)	112.5 (4.429)	137.0 (5.394)	15.0 (0.591)	4.5 (0.177)	153.0 (6.024)	131.0 (5.157)	M5
JBEP2021100	200.0 (7.874)	215.0 (8.465)	95.0 (3.740)	185.8 (7.315)	200.8 (7.906)	76.0 (2.992)	116.0 (4.567)	159.0 (6.260)	20.0 (0.787)	6.1 (0.240)	189.0 (7.441)	146.0 (5.748)	M6
JBEP2021150	200.0 (7.874)	215.0 (8.465)	145.0 (5.709)	185.8 (7.315)	200.8 (7.906)	122.5 (4.823)	114.8 (4.519)	159.0 (6.260)	20.0 (0.787)	6.1 (0.240)	189.0 (7.441)	146.0 (5.748)	M6
JBEP2532150	250.0 (9.843)	320.0 (12.598)	150.0 (5.906)	241.0 (9.488)	311.0 (12.244)	133.5 (5.256)	171.0 (6.732)	267.0 (10.512)	15.0 (0.591)	5.0 (0.197)	200.0 (7.874)	298.0 (11.732)	M6
JBEP3225150	320.0 (12.598)	250.0 (9.843)	150.0 (5.906)	311.0 (12.244)	241.0 (9.488)	133.5 (5.256)	267.0 (10.512)	171.0 (6.732)	15.0 (0.591)	5.0 (0.197)	298.0 (11.732)	200.0 (7.874)	M6
JBEP3250150	320.0 (12.598)	500.0 (19.685)	150.0 (5.906)	311.0 (12.244)	491.0 (19.331)	133.5 (5.256)	267.0 (10.512)	421.0 (16.575)	15.0 (0.591)	5.0 (0.197)	298.0 (11.732)	447.0 (17.598)	M6
JBEP3250230	320.0 (12.598)	500.0 (19.685)	230.0 (9.055)	311.0 (12.244)	491.0 (19.331)	213.5 (8.406)	267.0 (10.512)	421.0 (16.575)	15.0 (0.591)	5.0 (0.197)	298.0 (11.732)	447.0 (17.598)	M6
JBEP3275150	320.0 (12.598)	750.0 (29.528)	150.0 (5.906)	311.0 (12.244)	741.0 (29.173)	133.5 (5.256)	267.0 (10.512)	671.0 (26.417)	15.0 (0.591)	5.0 (0.197)	298.0 (11.732)	698.0 (27.480)	M6
JBEP3275230	320.0 (12.598)	750.0 (29.528)	230.0 (9.055)	311.0 (12.244)	741.0 (29.173)	213.5 (8.406)	267.0 (10.512)	671.0 (26.417)	15.0 (0.591)	5.0 (0.197)	298.0 (11.732)	698.0 (27.480)	M6

① Wall fixing screw diameter 5 mm (0.20"). Wall fixing screw hole 6 mm (0.24").

② Screw to be used for mounting box.

**ATX™ JBEP Series FRP Terminal Junction Boxes for Electrical and Power Applications**

Fiberglass Reinforced Polyester. Increased Safety. Factory Drilled and Equipped.

NEC/CEC:  
Class I, Zone 1, AEx e IIC, T5 or T6  
Ex e IIC, T5 or T6  
IP66

ATEX/IECEX:  
Zone 1 and 2 – 21 and 22  
II 2 GD  
IP66 – IK10

Dimensions in Millimeters (Inches) ①

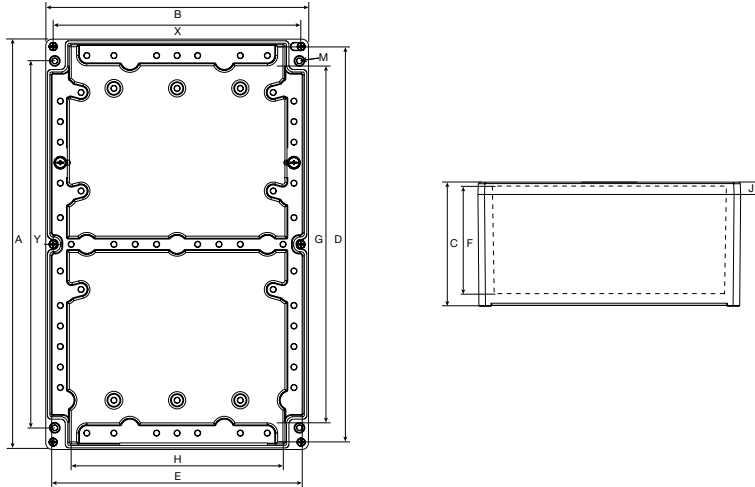

Enclosure Catalog Number	External Dimension				Internal Dimensions				Cover J	Body Thickness	Wall Fixing		M ②
	A	B	C	D	E	F	G	H			X	Y	
JBEP5032150	500 (19.685)	320 (12.598)	150 (5.906)	491 (19.331)	311 (12.244)	133.5 (5.256)	421 (16.575)	267 (10.512)	15 (0.591)	5 (0.197)	447 (17.598)	298 (11.732)	M6
JBEP5032230	500 (19.685)	320 (12.598)	230 (9.055)	491 (19.331)	311 (12.244)	213.5 (8.406)	421 (16.575)	267 (10.512)	15 (0.591)	5 (0.197)	447 (17.598)	298 (11.732)	M6
JBEP7532150	750 (29.528)	320 (12.598)	150 (5.906)	741 (29.173)	311 (12.244)	133.5 (5.256)	671 (26.417)	267 (10.512)	15 (0.591)	5 (0.197)	298 (11.732)	698 (27.480)	M6
JBEP7532230	750 (29.528)	320 (12.598)	230 (9.055)	741 (29.173)	311 (12.244)	213.5 (8.406)	671 (26.417)	267 (10.512)	15 (0.591)	5 (0.197)	698 (27.480)	298 (11.732)	M6

① Wall fixing screw diameter 5 mm (0.20"). Wall fixing screw hole 6 mm (0.24").

② Screw to be used for mounting box.

# ATX™ JBEP Series FRP Terminal Junction Boxes for Electrical and Power Applications

Fiberglass Reinforced Polyester. Increased Safety. Factory Drilled and Equipped.

NEC/CEC:  
Class I, Zone 1, AEx e IIC, T5 or T6  
Ex e IIC, T5 or T6  
IP66

ATEX/IECEX:  
Zone 1 and 2 – 21 and 22  
II 2 GD  
IP66 – IK10

Dimensions in Millimeters (Inches) ①

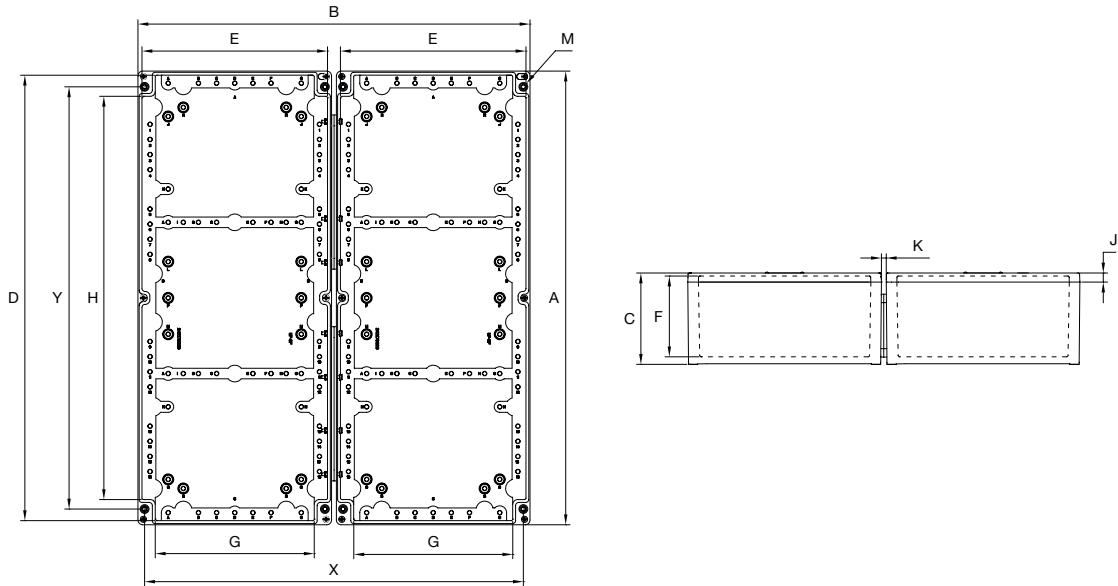

Enclosure Catalog Number	External Dimension			Internal Dimensions						Cover	Body	Wall Fixing		M ②
	A	B	C	D	E (x2)	F	G (x2)	H	J	Thickness	X	Y		
2 X JBEP7532150	750 (29.528)	648 (25.512)	150 (5.906)	741 (29.173)	311 (12.244)	133 (5.256)	267 (10.512)	671 (26.417)	8 (0.315)	15 (0.591)	5 (0.197)	626 (24.646)	698 (27.480)	M6

① Wall fixing screw diameter 5 mm (0.20"). Wall fixing screw hole 6 mm (0.24").  
② Screw to be used for mounting box.